



### ■ Features

- Constant Current mode output
- Metal housing design
- Built-in active PFC function
- No load power consumption <0.5W
- IP65 rating for indoor or outdoor installations
- Function options: output adjustable via potentiometer
- 3 years warranty

### ■ Applications

- LED flood lighting
- LED decorative lighting
- LED architectural lighting

### ■ Description

FDL-65 series is a 65W LED AC/DC LED power supply featuring the constant current mode output, targeting at but not limited to LED flood lighting applications. FDL-65 operates from 180 ~ 295VAC and offers models working perfectly for the voltage up to 42V (1550mA model) and 36V(1800mA model). Thanks to the high efficiency up to 90%, with the fanless design, the entire series is able to operate for -40°C ~ +90°C case temperature under free air convection. The design of metal housing and IP65 ingress protection level allows this series to fit both indoor and outdoor applications. FDL-65 is equipped with output current adjustable function so as to provide the optimal design flexibility for LED lighting system.

### ■ Model Encoding

**FDL - 65 - 1800**

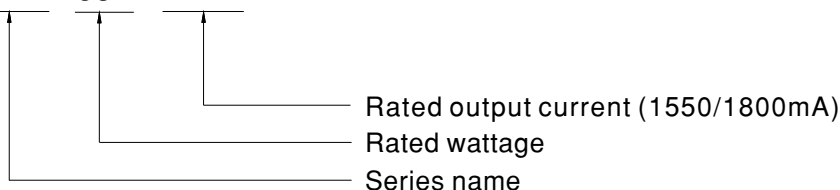



**SPECIFICATION**

MODEL		FDL-65-1550	FDL-65-1800
OUTPUT	RATED CURRENT	1550mA	1800mA
	RATED POWER	65.1W	64.8W
	CONSTANT CURRENT REGION <small>Note.2</small>	25.2 ~ 42V	21.6 ~ 36V
	OPEN CIRCUIT VOLTAGE <sub>(max.)</sub>	50V	45V
	CURRENT ADJ. RANGE	0.77-1.55A	0.9~1.8A
	CURRENT TOLERANCE	±5.0%	
	SET UP TIME <small>Note.3</small>	500ms/230VAC	
INPUT	VOLTAGE RANGE	180 ~ 295VAC 254 ~ 417VDC (Please refer to "STATIC CHARACTERISTIC" section)	
	FREQUENCY RANGE	47 ~ 63Hz	
	POWER FACTOR <small>(Typ.)</small>	PF ≥ 0.95/230VAC, PF ≥ 0.90/277VAC@full load (Please refer to "POWER FACTOR (PF) CHARACTERISTIC" section)	
	TOTAL HARMONIC DISTORTION	THD < 20% (@load ≥ 60%/230VAC; @load ≥ 75%/277VAC) (Please refer to "TOTAL HARMONIC DISTORTION (THD)" section)	
	EFFICIENCY <small>(Typ.)</small>	90%	90%
	AC CURRENT <small>(Typ.)</small>	0.48A / 230VAC 0.39A/277VAC	
	INRUSH CURRENT <sub>(Typ.)</sub>	COLD START 50A(twidth=270µs measured at 50% Ipeak)/230VAC; Per NEMA 410	
	MAX. No. of PSUs on 16A CIRCUIT BREAKER	28 units (circuit breaker of type B) / 32 units (circuit breaker of type C) at 230VAC	
	LEAKAGE CURRENT	<0.75mA / 277VAC	
	NO LOAD POWER CONSUMPTION	<0.5W	
PROTECTION	SHORT CIRCUIT	Hiccup mode, recovers automatically after fault condition is removed	
	OVER VOLTAGE	46 ~ 56V	40 ~ 48V
	OVER TEMPERATURE	Hiccup mode, recovers automatically after fault condition is removed	
ENVIRONMENT	WORKING TEMP.	Tcase=-40 ~ +90°C (Please refer to "OUTPUT LOAD vs TEMPERATURE" section)	
	MAX. CASE TEMP.	Tcase=+90°C	
	WORKING HUMIDITY	20 ~ 95% RH non-condensing	
	STORAGE TEMP., HUMIDITY	-40 ~ +80°C, 10 ~ 95% RH	
	TEMP. COEFFICIENT	±0.03%/°C (0 ~ 60°C)	
	VIBRATION	10 ~ 500Hz, 5G 12min./1cycle, period for 72min. each along X, Y, Z axes	
SAFETY & EMC	SAFETY STANDARDS	LVD EN61347-1, EN61347-2-13 Independent, GB19510.1, GB19510.14, IP65 approved	
	WITHSTAND VOLTAGE	I/P-O/P: 3.75KVAC I/P-FG: 2KVAC O/P-FG: 1.5KVAC	
	ISOLATION RESISTANCE	I/P-O/P: 100M Ohms / 500VDC / 25°C / 70% RH	
	EMC EMISSION	Compliance to EN55015, EN61000-3-2 Class C (load ≥ 60%); EN61000-3-3, GB17743, GB17625.1	
	EMC IMMUNITY	Compliance to EN61000-4-2, 3, 4, 5, 6, 8, 11; EN61547, light industry level (surge immunity: Line-Earth: 4KV, Line-Line: 2KV)	
OTHERS	MTBF	594.9K hrs min. MIL-HDBK-217F (25°C)	
	DIMENSION	151*53*31.5mm (L*W*H)	
	PACKING	0.42Kg; 24pcs / 11.08Kg / 0.73CUFT	
NOTE	<ol style="list-style-type: none"> <li>All parameters NOT specially mentioned are measured at 230VAC input, rated current and 25°C of ambient temperature.</li> <li>Please refer to "DRIVING METHODS OF LED MODULE".</li> <li>Length of set up time is measured at first cold start. Turning ON/OFF the power supply may lead to increase of the set up time.</li> <li>The driver is considered as a component that will be operated in combination with final equipment. Since EMC performance will be affected by the complete installation, the final equipment manufacturers must re-qualify EMC Directive on the complete installation again.</li> </ol>		

■ **BLOCK DIAGRAM**

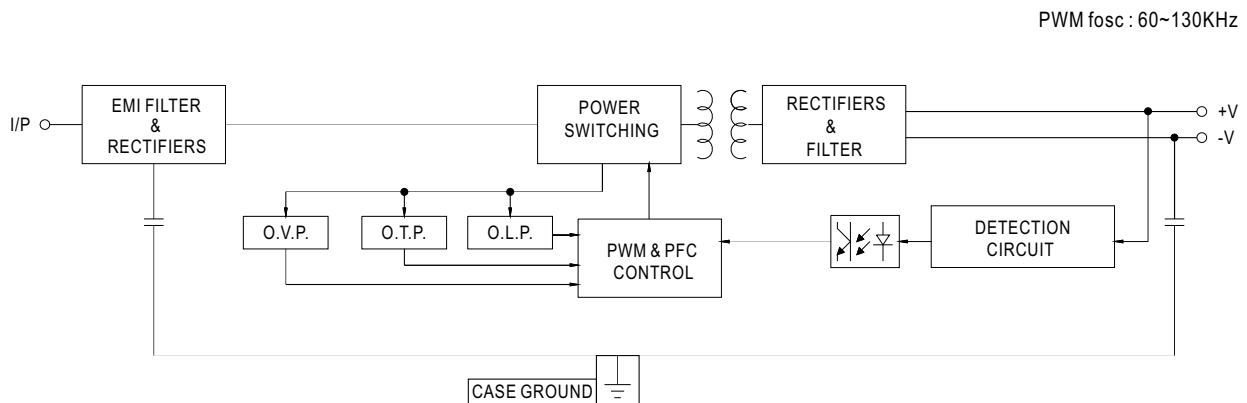

■ **DRIVING METHODS OF LED MODULE**

※ This series works in constant current mode to directly drive the LEDs.

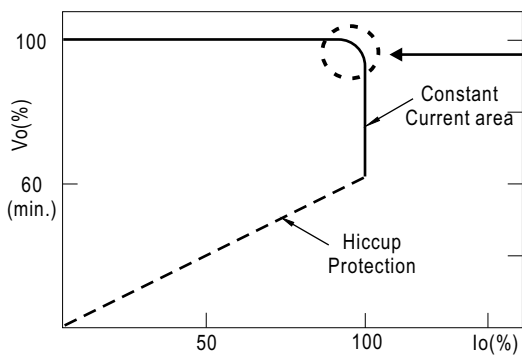

Typical output current normalized by rated current (%)

In the constant current region, the highest voltage at the output of the driver depends on the configuration of the end systems.  
Should there be any compatibility issues, please contact MEAN WELL.

**OUTPUT LOAD vs TEMPERATURE**

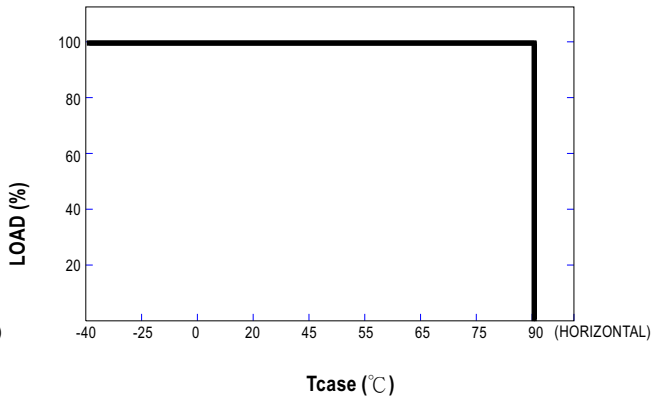
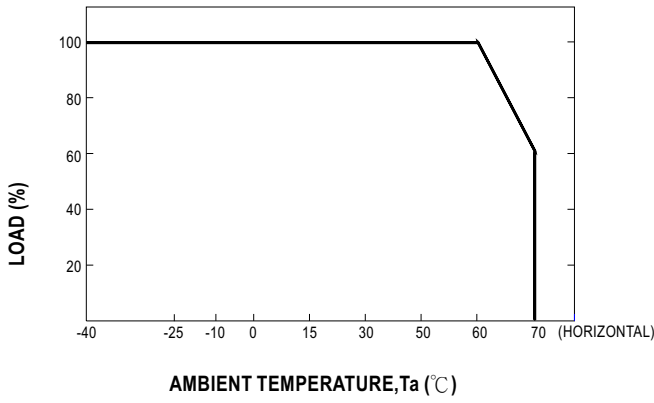

**STATIC CHARACTERISTIC**

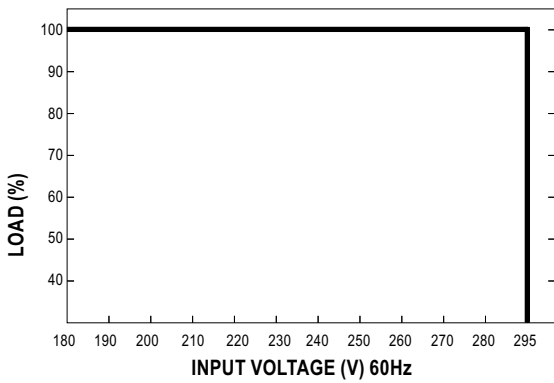

**POWER FACTOR (PF) CHARACTERISTIC**

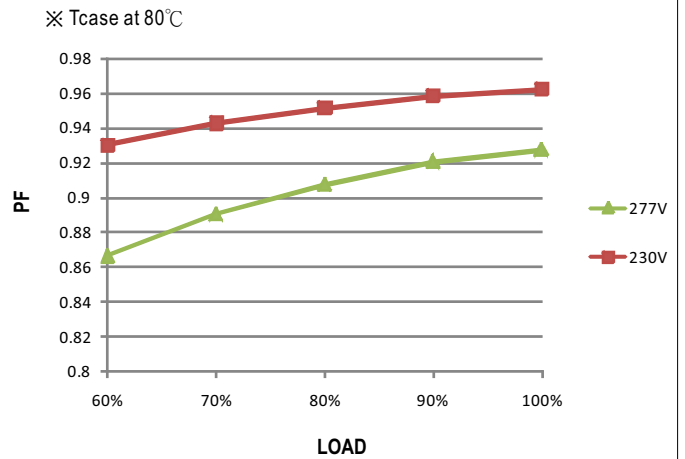

**TOTAL HARMONIC DISTORTION (THD)**

× 1800mA Model, Tcase at 80°C

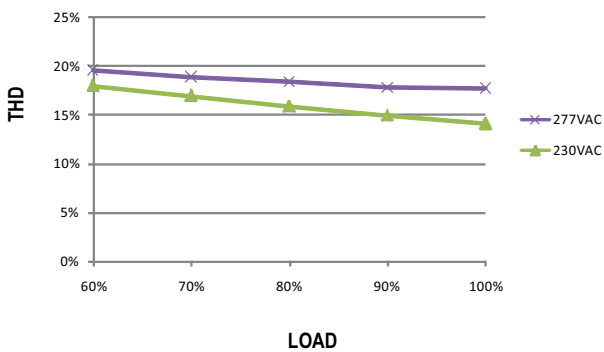

**EFFICIENCY vs LOAD**

FDL-65 series possess superior working efficiency that up to 90% can be reached in field applications.

× 1800mA Model, Tcase at 80°C

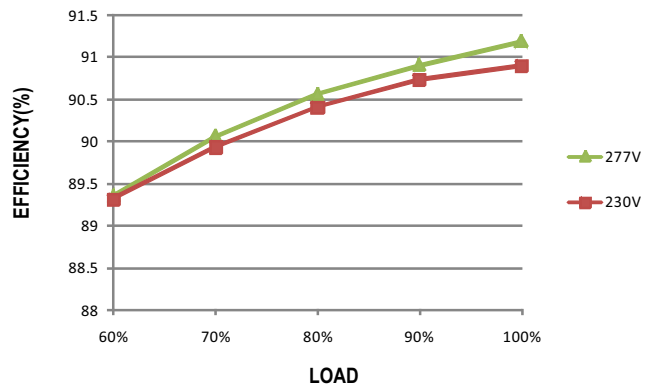

■ MECHANICAL SPECIFICATION

CASE NO.: 246A Unit:mm

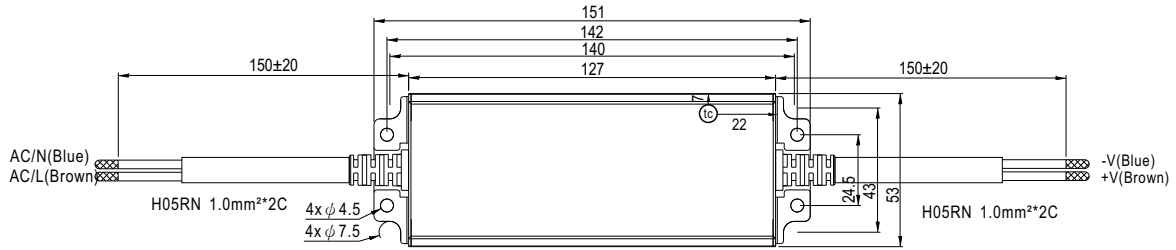

• (tc) : Max. Case Temperature

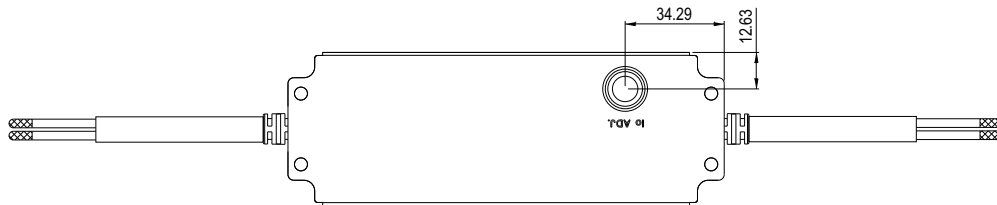
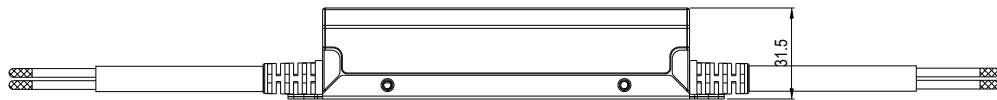

◎ Note: Please connect the case to FG for the complete EMC deliverance.

■ INSTALLATION MANUAL

Please refer to : <http://www.meanwell.com/webnet/search/InstallationSearch.html>