

60x60x25 mm

29.0~40.0 CFM



■ Specification

Model	Bearing	Rated Voltage	Power Current	Power Consumption	Speed	Airflow	Static Pressure	Noise	Weight	Curve
	2BALL Sleeve	(VDC)	(mA)	(WATTS)	(RPM)	(CFM)	(inch-H ₂ O)	(dB(A))	(g)	
PE60251BX-0000-A99	☼	12	370	4.44	7600	40.0	0.64	46.0	71.0	1
PE60251B1-0000-A99	☼	12	297	3.57	6900	36.0	0.54	44.0	71.0	2
PE60251B2-0000-A99	☼	12	232	2.79	6100	31.5	0.42	42.0	71.0	3
PE60251B3-0000-A99	☼	12	197	2.37	5600	29.0	0.36	38.0	71.0	4
PE60252BX-0000-A99	☼	24	190	4.56	7600	40.0	0.64	46.0	75.0	1
PE60252B1-0000-A99	☼	24	155	3.72	6900	36.0	0.54	44.0	75.0	2
PE60252B2-0000-A99	☼	24	121	2.91	6100	31.5	0.42	42.0	75.0	3
PE60252B3-0000-A99	☼	24	104	2.50	5600	29.0	0.36	38.0	75.0	4

■ Function R Type : F99 / F Type : G99

■ Air Flow-Static Pressure Characteristics

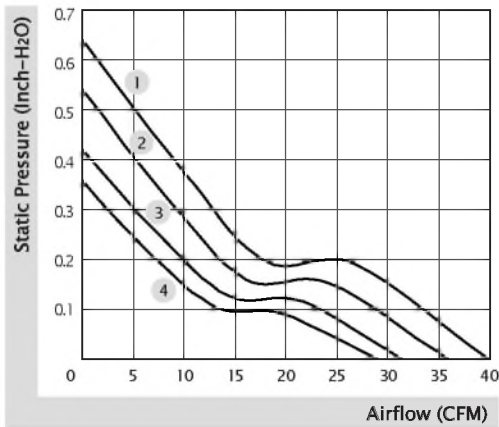

■ External Dimensions(mm)

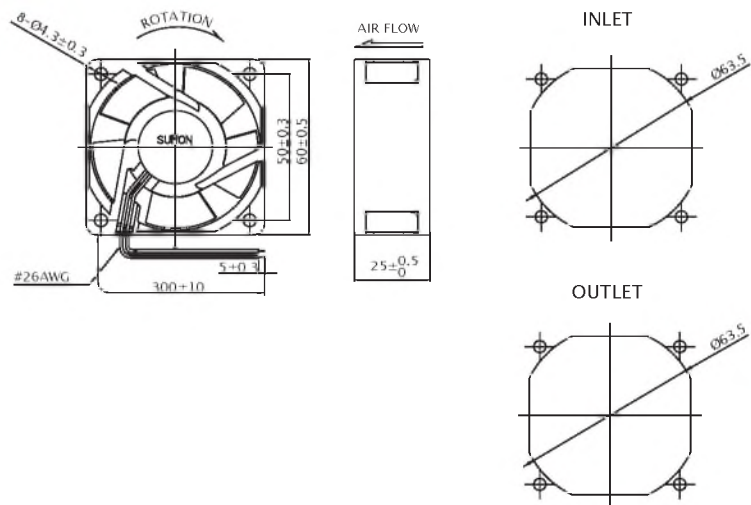

* All model could be customized. Please contact with Sunon Sales.

* Specifications are subject to change without notice. Please Visit SUNON website at www.sunon.com for update information.

■ RD / FG Output Signal

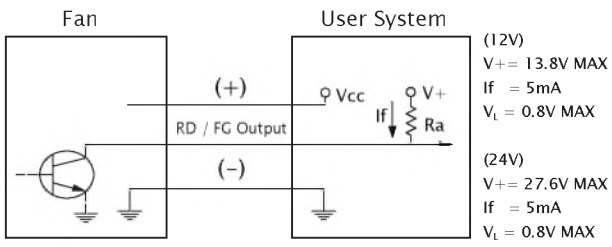

[RD Signal]

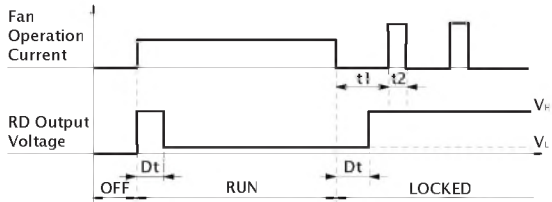

[FG Signal]

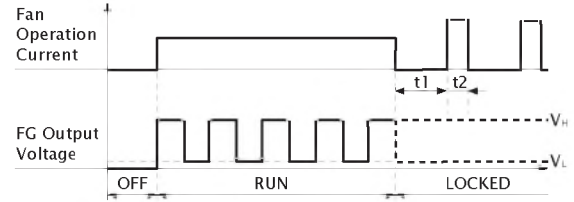
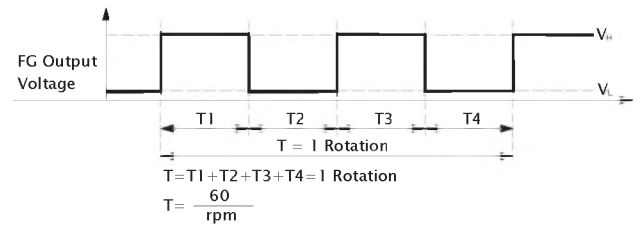

60x60x25 mm

16.0~27.0 CFM



■ Specification

	Bearing	Rated Voltage	Power Current	Power Consumption	Speed	Airflow	Static Pressure	Noise	Weight	Curve
	● VAPO	(VDC)	(mA)	(WATTS)	(RPM)	(CFM)	(Inch-H ₂ O)	(dB(A))	(g)	
MF60251VX-10000-A99	●	12	130	1.56	5200	27.0	0.31	31.2	45.0	1
MF60251V1-10000-A99	●	12	75	0.90	4500	23.5	0.21	27.0	45.0	2
MF60251V2-10000-A99	●	12	72	0.87	3800	19.3	0.15	22.0	45.0	3
MF60251V3-10000-A99	●	12	44	0.53	3100	16.0	0.10	16.7	45.0	4
MF60252VX-10000-A99	●	24	80	1.92	5200	27.0	0.31	31.2	45.0	1
MF60252V1-10000-A99	●	24	50	1.20	4500	23.5	0.21	27.0	45.0	2
MF60252V2-10000-A99	●	24	30	0.72	3800	19.3	0.15	22.0	45.0	3
MF60252V3-10000-A99	●	24	22	0.53	3100	16.0	0.10	16.7	45.0	4
Model	○ 2BALL Sleeve	(VDC)	(mA)	(WATTS)	(RPM)	(CFM)	(Inch-H ₂ O)	(dB(A))	(g)	
EE60251S1-10000-999	○	12	122	1.47	4500	23.5	0.21	27.0	45.0	2
EE60251S2-10000-999	○	12	85	1.02	3800	19.3	0.15	22.0	45.0	3
EE60251S3-10000-999	○	12	60	0.72	3100	16.0	0.10	16.7	45.0	4
EF60252S1-10000-A99	○	24	50	1.20	4500	23.5	0.21	27.0	45.0	2

- Function (MF Series) R Type : F99 / F Type : G99
- (EE Series) F Type : C99
- (EF Series) F Type : G99

■ Air Flow-Static Pressure Characteristics

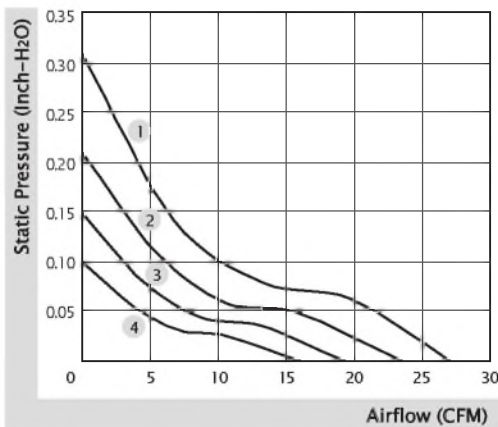

■ External Dimensions(mm)

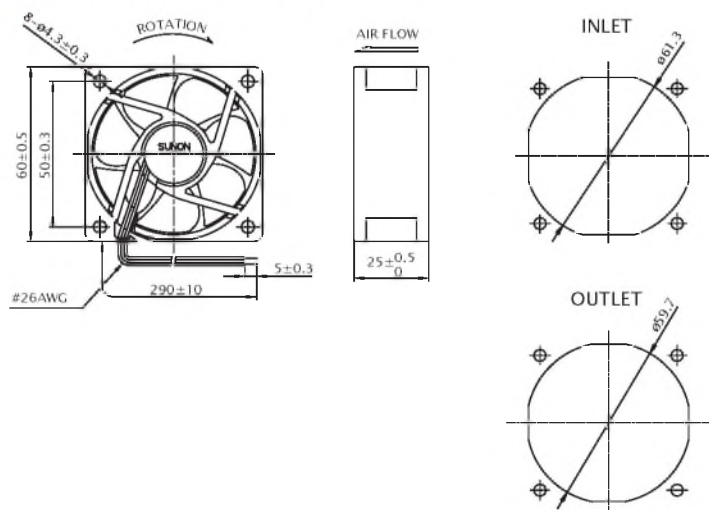

※ All model could be customized. Please contact with Sunon Sales.
 ※ Specifications are subject to change without notice. Please Visit SUNON website at www.sunon.com for update information.

RD / FG Output Signal

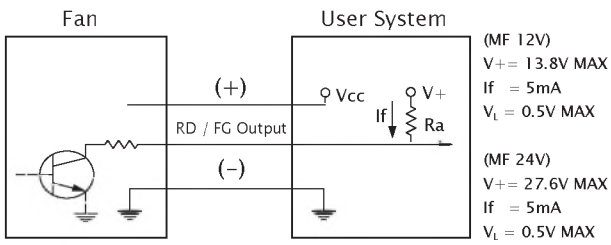

[RD Signal]

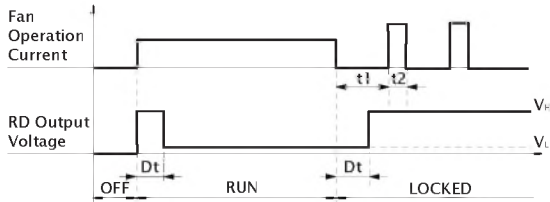

[FG Signal]

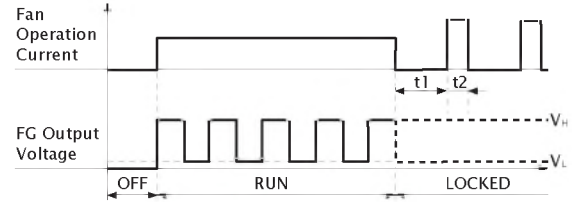
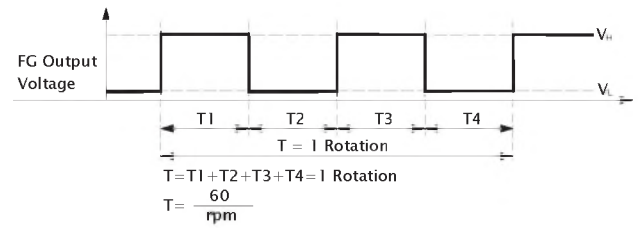

Non-Auto Restart (C99) FG Output Signal

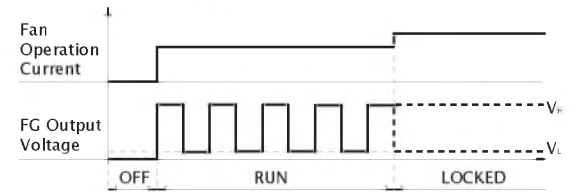
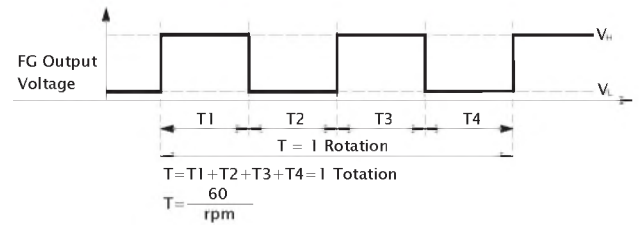
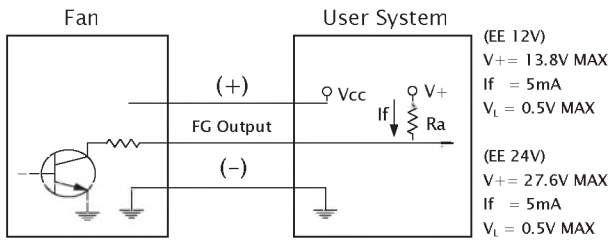

60x60x25 mm

13.9~23.5 CFM



■ Specification

Model	Bearing	Rated Voltage	Power Current	Power Consumption	Speed	Airflow	Static Pressure	Noise	Weight	Curve
	2BALL Sleeve	(VDC)	(mA)	(WATTS)	(RPM)	(CFM)	(inch-H ₂ O)	(dB(A))	(g)	
EE60251B1-0000-999	☛	12	120	1.44	4500	23.5	0.21	34.5	50.0	1
EE60251B2-0000-999	☛	12	78	0.94	3800	19.3	0.15	30.0	50.0	2
EE60251B3-0000-999	☛	12	58	0.70	3000	13.9	0.08	20.0	50.0	3
EE60252B1-0000-A99	☛	24	70	1.68	4500	23.5	0.21	34.5	50.0	1
EE60252B2-0000-A99	☛	24	47	1.13	3800	19.3	0.15	30.0	50.0	2
EE60252B3-0000-A99	☛	24	30	0.72	3000	13.9	0.08	20.0	50.0	3

■ Function (12V) Auto Restart : A99 / R Type : F99 / F Type : C99, G99
 (24V) R Type : F99 / F Type : G99

■ Air Flow-Static Pressure Characteristics

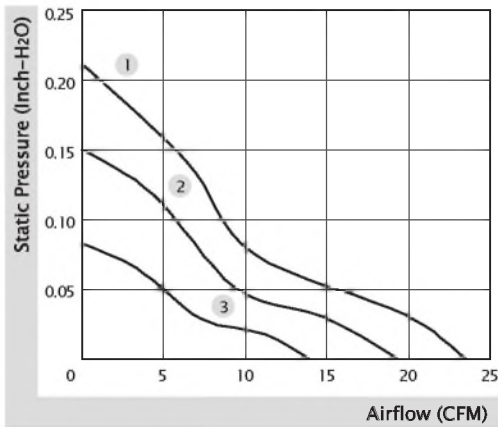

■ External Dimensions(mm)

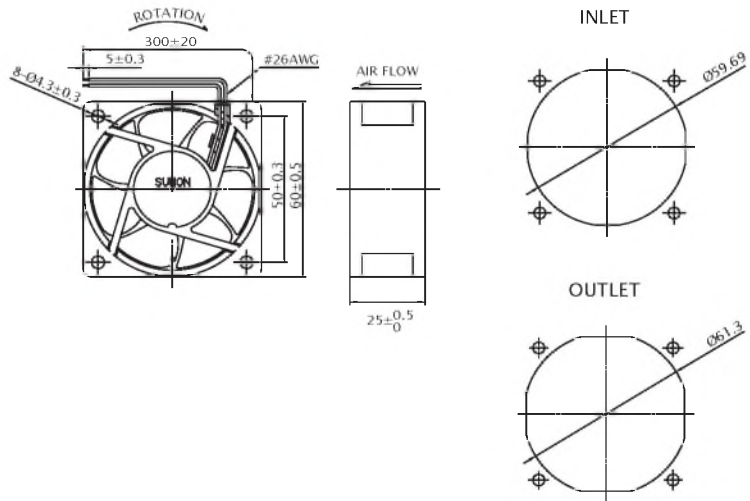

※ All model could be customized. Please contact with Sunon Sales.

※ Specifications are subject to change without notice. Please Visit SUNON website at www.sunon.com for update information.

RD / FG Output Signal

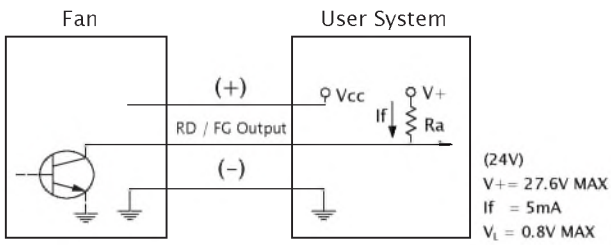

[RD Signal]

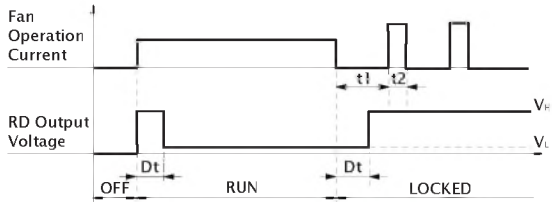

[FG Signal]

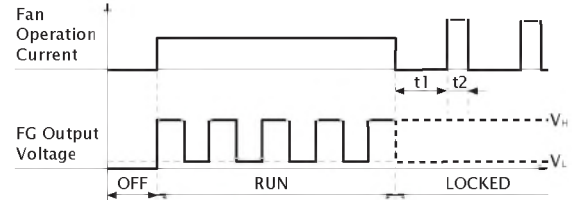
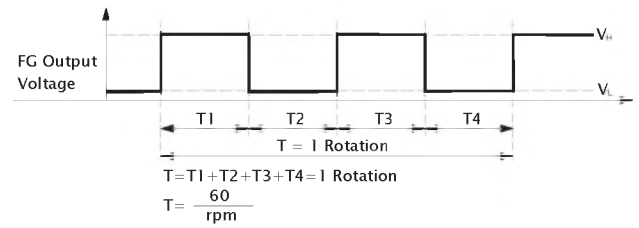

Non-Auto Restart (C99) FG Output Signal

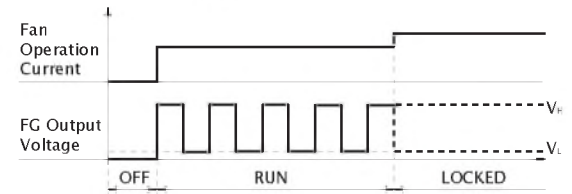
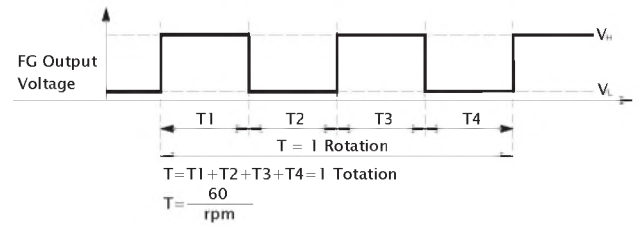
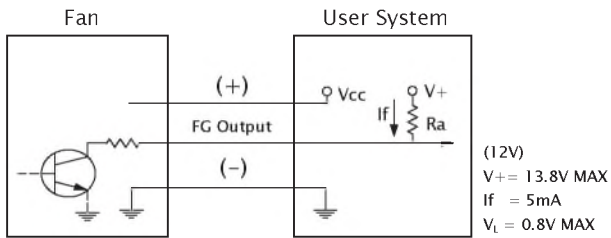

60x60x25 mm

13.8 CFM



■ Specification

	Bearing	Rated Voltage	Power Current	Power Consumption	Speed	Airflow	Static Pressure	Noise	Weight	Curve
	● VAPO	(VDC)	(mA)	(WATTS)	(RPM)	(CFM)	(inch-H ₂ O)	(dB(A))	(g)	
HA60251V4-10000-A99	●	12	20	0.24	2500	13.8	0.06	10.7	45.0	1

■ Function F Type : G99

■ Air Flow-Static Pressure Characteristics

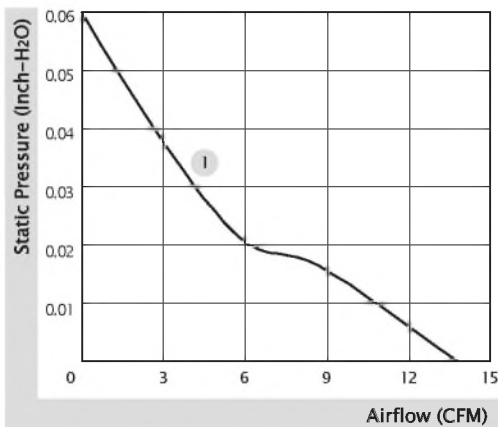

■ External Dimensions(mm)

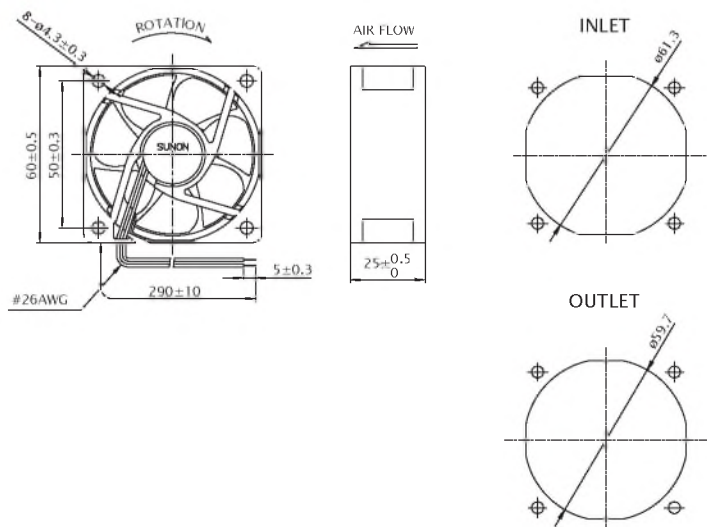

* All model could be customized. Please contact with Sunon Sales.

* Specifications are subject to change without notice. Please Visit SUNON website at www.sunon.com for update information.

■ FG Output Signal

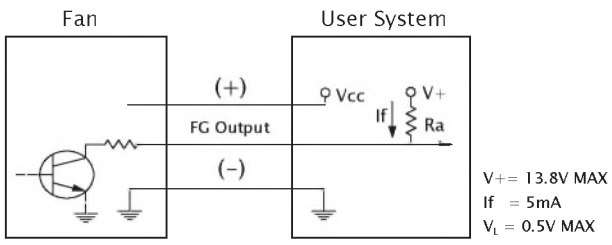

[FG Signal]

