

OEM Relative and differential pressure switch type 605

Pressure range
20 ... 400 Pa



Type 605 pressure switches are specially developed for use in gas fired heating systems. There are more than 40 million switches in use worldwide. Produced on a fully automated production line. High setting accuracy and repeatability, combined with excellent reliability characterise a quality of switch above the industry norm.

- Fitting of the switch – Fast mounting with snap bracket system
- Adjusting security
- High contact strength (typically 10 cN)
 - Essentially less susceptibility to pollution of contact
- Roll operation of contact surface
 - Less sensitive to contact pollution through self cleaning effect
- Diaphragm design / material
 - Better long term stability achieved through the use of a 2 component silicon diaphragm.
 - Unique trapezoid diaphragm design provides for a better contact release and therefore a more accurate switching point

Technical overview

Pressure range		
Relative and differential		20 ... 400 Pa ¹⁾
Operating conditions		
Medium		Air and neutral gases
Temperature ²⁾	Medium / ambient	-30 ... +110 °C
	Storage	-30 ... +110 °C
	< +85 °C	5000 Pa
Tolerable overload on one side	+85 ... +110 °C	1500 Pa
Smallest turn on pressure of 20 Pa ³⁾		Smallest switching differential 8 Pa
Materials in contact with the medium		
Sensor		Silicone LSR
Case		PC Lexan 500R ⁴⁾
Electrical overview		
Switching load		See Nominal loading limits
Contact system	Changeover switch	
Service life	Mechanically	> 10 ⁶ switching cycles
Protection standard		
Not mounted		IP 00
With contact safety guard		IP 30
With cover, without seal		IP 54
With cover and seal		IP 65
Reproducibility		
Between		± 1 Pa
Electrical connection		
AMP connector ⁵⁾		6.3 mm 4.8 mm
Pressure connections		
Pipe		Ø 6.2 mm
Orifice installed for damping pulsating pressure at P1, P2 (option)		
Mounting instructions		
Installation arrangement		Please indicate installation arrangement With several brackets
Mounting		Fastening clip for quick mounting
Tests / Admissions		
UL		MFHX2/8 or XAAK2/8
DVGW		acc. to DIN EN 1854
EC type examination certificate		CE-0085AP0974
Low voltage directive		2006/95/EC
Gas appliance directive		2009/142/EC
Weight		
Without accessories		~ 60 g
Packaging		
Multiple packaging in cardboard		300 pieces 1200 pieces

Adjustable switching differences

Switching difference adjustment only inside shaded area:

Example: Upper switching point 220 pascal.
Switching difference between 14 and 36 pascal.

Example: Upper switching point 40 pascal.
Switching difference between 9 and 30 pascal.

Example: Upper switching point 20 pascal,
smallest switching difference 8 pascal.

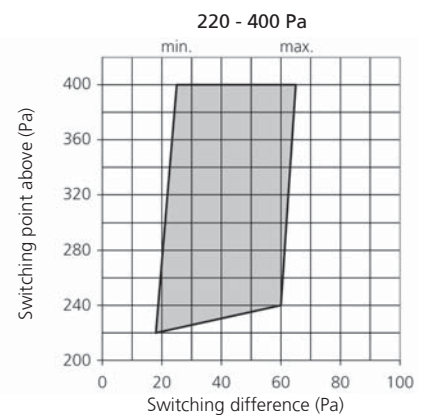
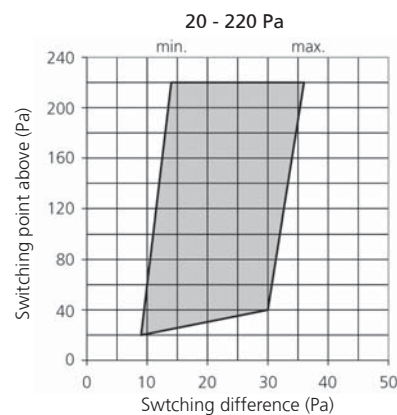

¹⁾ Higher pressures on request
⁴⁾ Fiberglass reinforced plastic 10% GF

²⁾ Higher temperatures on request
⁵⁾ According to DIN 46244

³⁾ Switching differential is factory-set

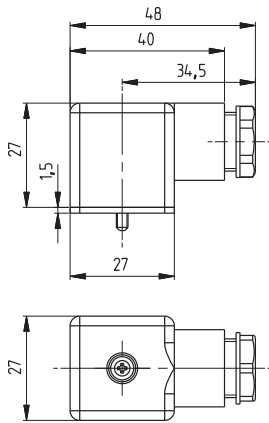
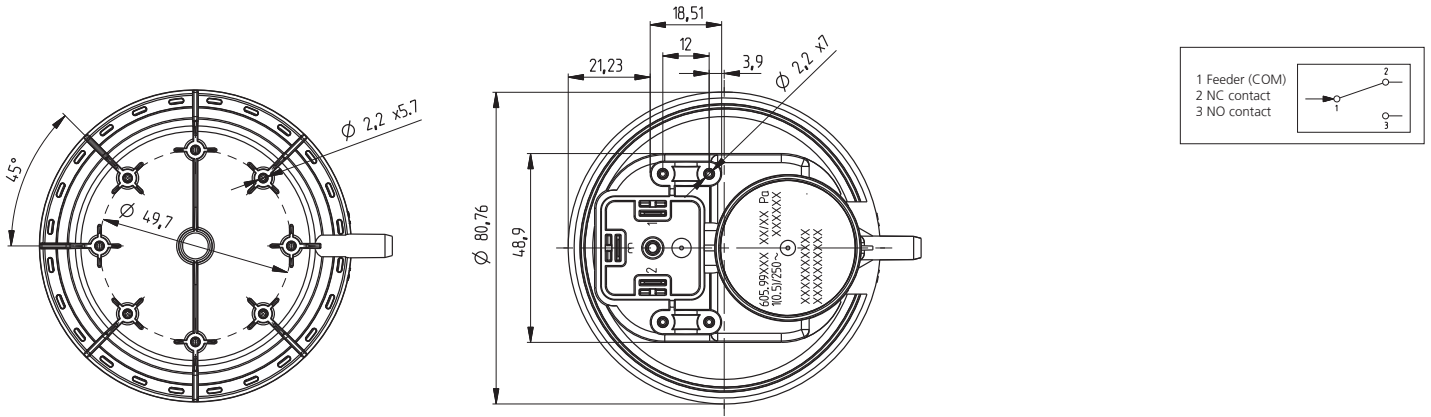

Cover with / without sealing and PT screw

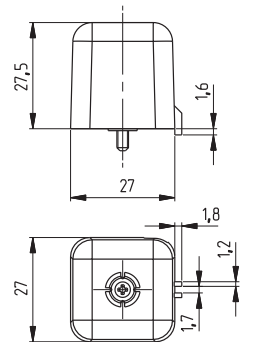
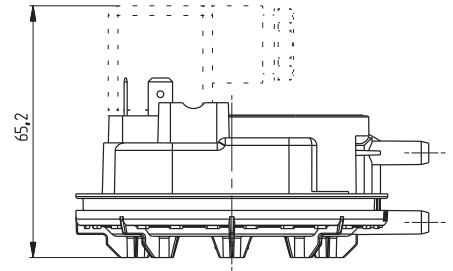

Contact safety guard with PT screw
Cable exit AMP1 or AMP2

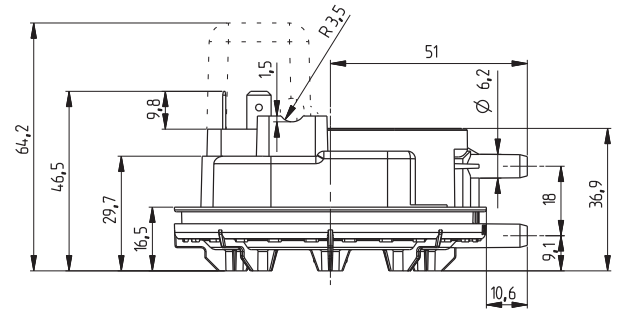

Tolerance of switching point

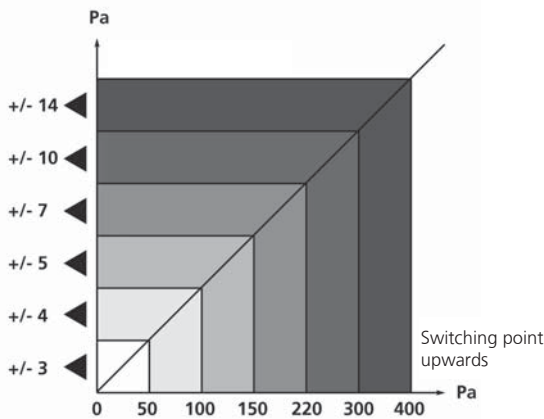

The principle of high contact pressure

Simplified representation of the new DPS 605 contact system. The high contact pressure results from the optimized length ratios of LC and LD.

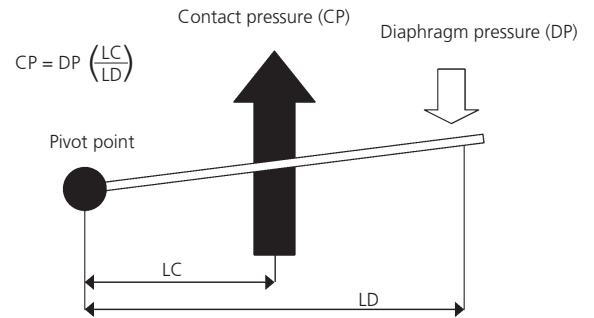

LC = Length of contact lever
LM = Length of diaphragm lever

Cover with seal and PT screw	Order number	100306
Cover without seal and PT screw		100307
Cover with PT screw and cable output AMP-1		100297 + 102981 (PT screw)
Cover with PT screw and cable output AMP-2		100298 + 102981 (PT screw)
Fastening clip	Thickness of sheet metal 0.8 ... 1.1 mm	100294
	Thickness of sheet metal 1.8 ... 2.1 mm	100293
Fastening clip (with mounting holes)		106790
Bracket type A		100295
Bracket type B		100296
Mounting plate		106707
Mounting adaptor small		111223
Mounting adaptor large		112985
Calibration certificate		104551

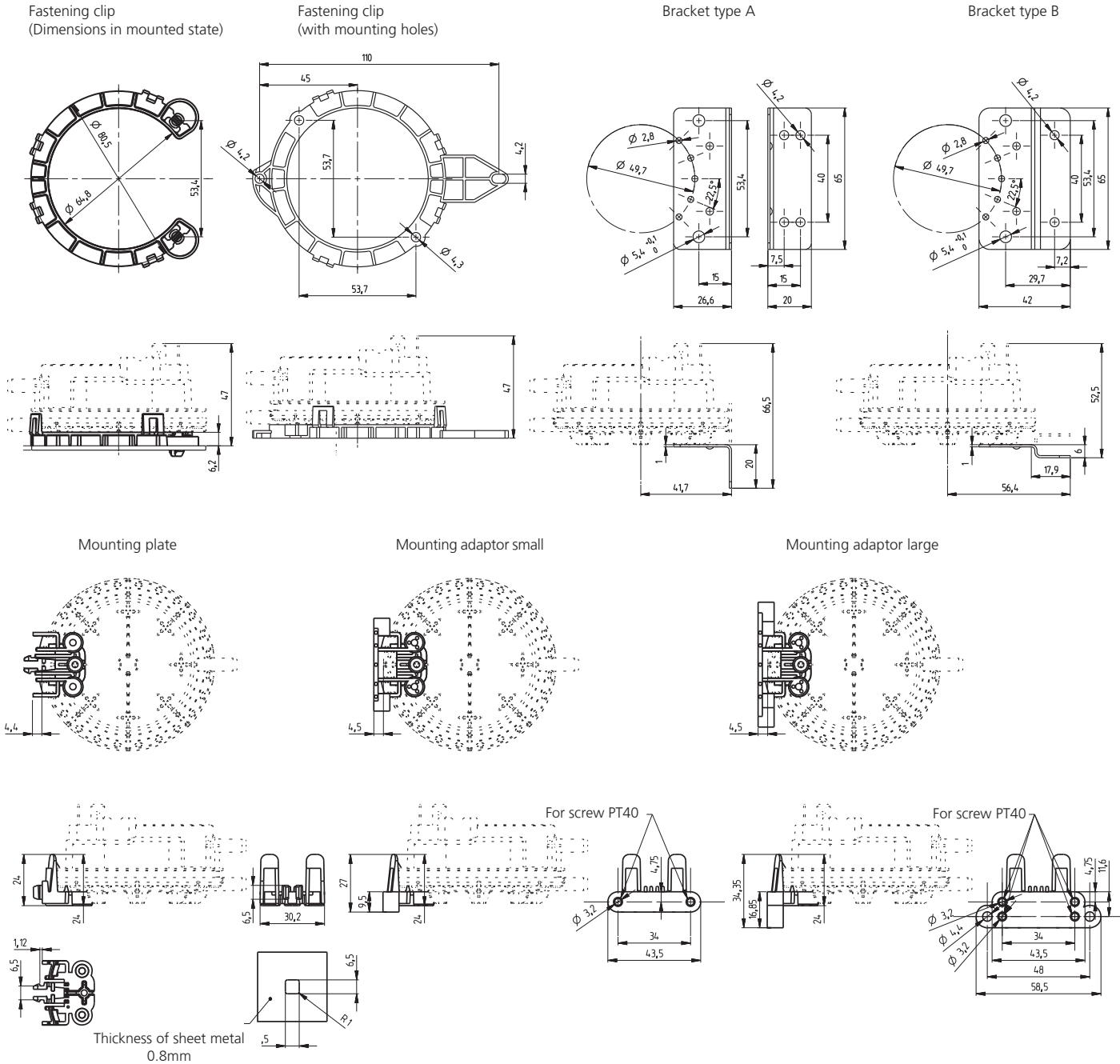

Nominal loading limits

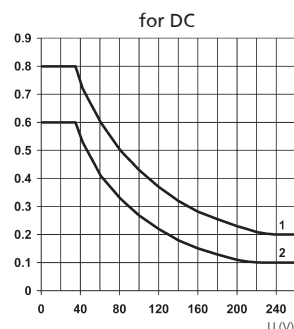
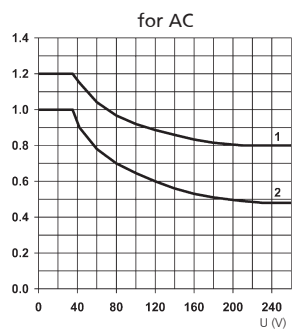

Huba Control AG
Headquarters

Industriestrasse 17
5436 Würenlos
Telefon +41 (0) 56 436 82 00
Telefax +41 (0) 56 436 82 82
info.ch@hubacontrol.com

Huba Control AG
Niederlassung Deutschland

Schlattgrabenstrasse 24
72141 Walddorfhäslach
Telefon +49 (0) 7127 23 93 00
Telefax +49 (0) 7127 23 93 20
info.de@hubacontrol.com

Huba Control SA
Succursale France

Rue Lavoisier
Technopôle Forbach-Sud
57602 Forbach Cedex
Téléphone +33 (0) 387 847 300
Télécopieur +33 (0) 387 847 301
info.fr@hubacontrol.com

Huba Control AG
Vestiging Nederland

Hamseweg 20A
3828 AD Hoogland
Telefoon +31 (0) 33 433 03 66
Telefax +31 (0) 33 433 03 77
info.nl@hubacontrol.com

Huba Control AG
Branch Office United Kingdom

Unit 13 Berkshire House
County Park Business Centre
Shrivenham Road
Swindon Wiltshire SN1 2NR
Phone +44 (0) 1993 776667
Fax +44 (0) 1993 776671
info.uk@hubacontrol.com