

70x70x20 mm

23.5~29.0 CFM



■ Specification

	Bearing	Rated Voltage	Power Current	Power Consumption	Speed	Airflow	Static Pressure	Noise	Weight	Curve
	● VAPO	(VDC)	(mA)	(WATTS)	(RPM)	(CFM)	(Inch-H ₂ O)	(dB(A))	(g)	
ME70201V1-0000-A99	●	12	130	1.56	3200	29.0	0.14	33.0	60.0	1
ME70201V2-0000-A99	●	12	99	1.19	2900	27.0	0.12	30.0	60.0	2
ME70201V3-0000-A99	●	12	77	0.93	2600	23.5	0.09	26.0	60.0	3
ME70202V1-0000-A99	●	24	66	1.59	3200	29.0	0.14	33.0	60.0	1
ME70202V2-0000-A99	●	24	55	1.32	2900	27.0	0.12	30.0	60.0	2
ME70202V3-0000-A99	●	24	44	1.06	2600	23.5	0.09	26.0	60.0	3

■ Function R Type : F99 / F Type : G99

■ Air Flow-Static Pressure Characteristics

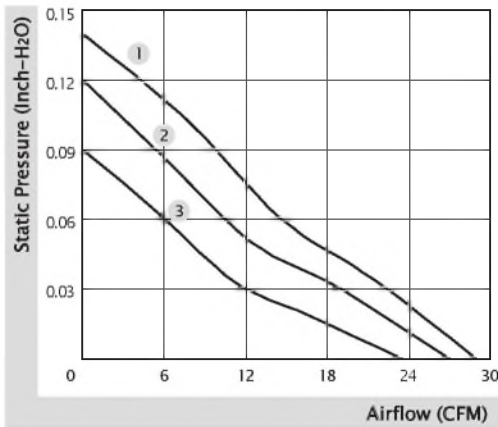

■ External Dimensions(mm)

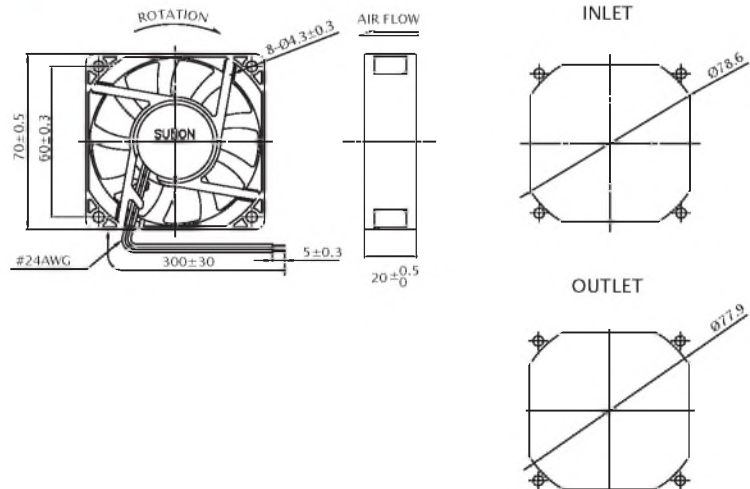

※ All model could be customized. Please contact with Sunon Sales.

※ Specifications are subject to change without notice. Please Visit SUNON website at www.sunon.com for update information.

■ RD / FG Output Signal

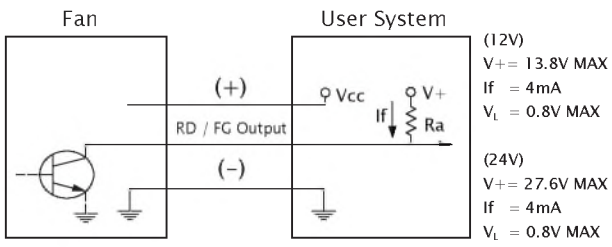

[RD Signal]

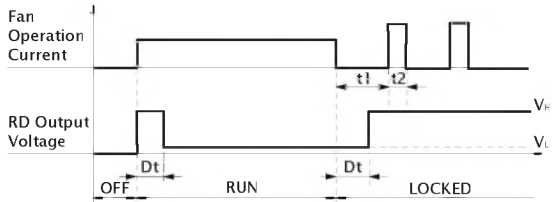

[FG Signal]

