













70x70x15 mm

19~27 CFM



	P/N	Bearing	Rating Voltage (VDC)	Power Current (AMP)	Power Consumption (WATTS)	Speed (RPM)	Air Flow (CFM)	Static Pressure (Inch-H ₂ O)	Noise (dBA)	Weight (g)	Curve
KDE0507PHV2	MS.A.GN	●	5	0.2	1.0	2800	23	0.09	26.5	52	2
KDE0507PHV3	MS.A.GN	●	5	0.11	0.6	2300	19	0.07	21.5	52	3
KDE1207PHV1	MS.A.GN	●	12	0.16	1.9	3300	27	0.11	31.5	50	1
KDE1207PHV2	MS.A.GN	●	12	0.09	1.1	2800	23	0.09	26.5	50	2
KDE1207PHV3	MS.A.GN	●	12	0.05	0.6	2300	19	0.07	21.5	50	3
KDE2407PHV1	MS.A.GN	●	24	0.086	2.1	3300	27	0.11	31.5	52	2
KDE2407PHV2	MS.A.GN	●	24	0.054	1.3	2800	23	0.09	26.5	52	3

Model	P/N		(VDC)	(AMP)	(WATTS)	(RPM)	(CFM)	(Inch-H ₂ O)	(dBA)	(g)	Curve
KD0507PHB2	(2).GN		5	0.218	1.1	2800	23	0.09	27.5	52	2
KD0507PHB3	(2).GN		5	0.13	0.7	2300	19	0.07	22.5	52	3
KD0507PHS2	GN		5	0.218	1.1	2800	23	0.09	26.5	52	2
KD0507PHS3	GN		5	0.131	0.7	2300	19	0.07	21.5	52	3
KD1207PHB1	(2).GN		12	0.173	2.1	3300	27	0.11	32.5	50	1
KD1207PHB2	(2).GN		12	0.104	1.3	2800	23	0.09	27.5	50	2
KD1207PHB3	(2).GN		12	0.066	0.8	2300	19	0.07	22.5	50	3
KD1207PHS1	GN		12	0.171	2.1	3300	27	0.11	31.5	50	1
KD1207PHS2	GN		12	0.102	1.2	2800	23	0.09	26.5	50	2
KD1207PHS3	GN		12	0.067	0.8	2300	19	0.07	21.5	50	3

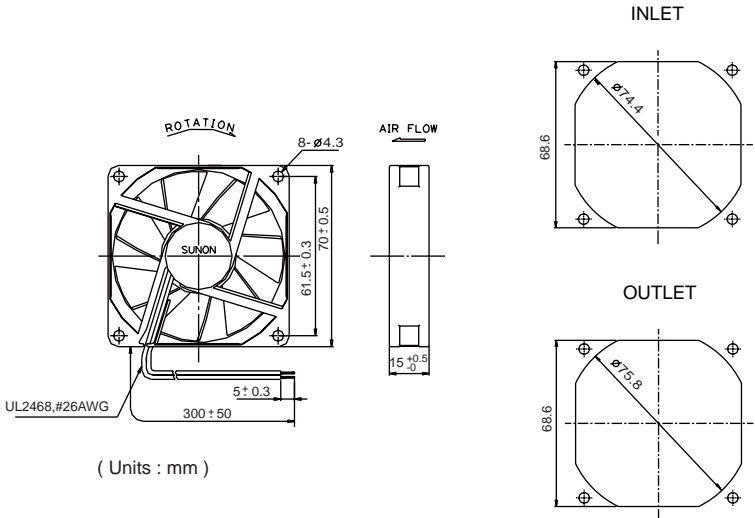
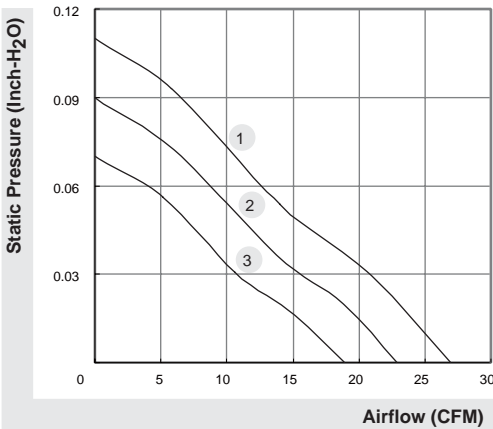

*All model could be customized. Please contact with Sunon Sales.
 *Specifications subject to change without notice. Please Visit SUNON web site at <http://www.sunon.com> for update information.