

trafford

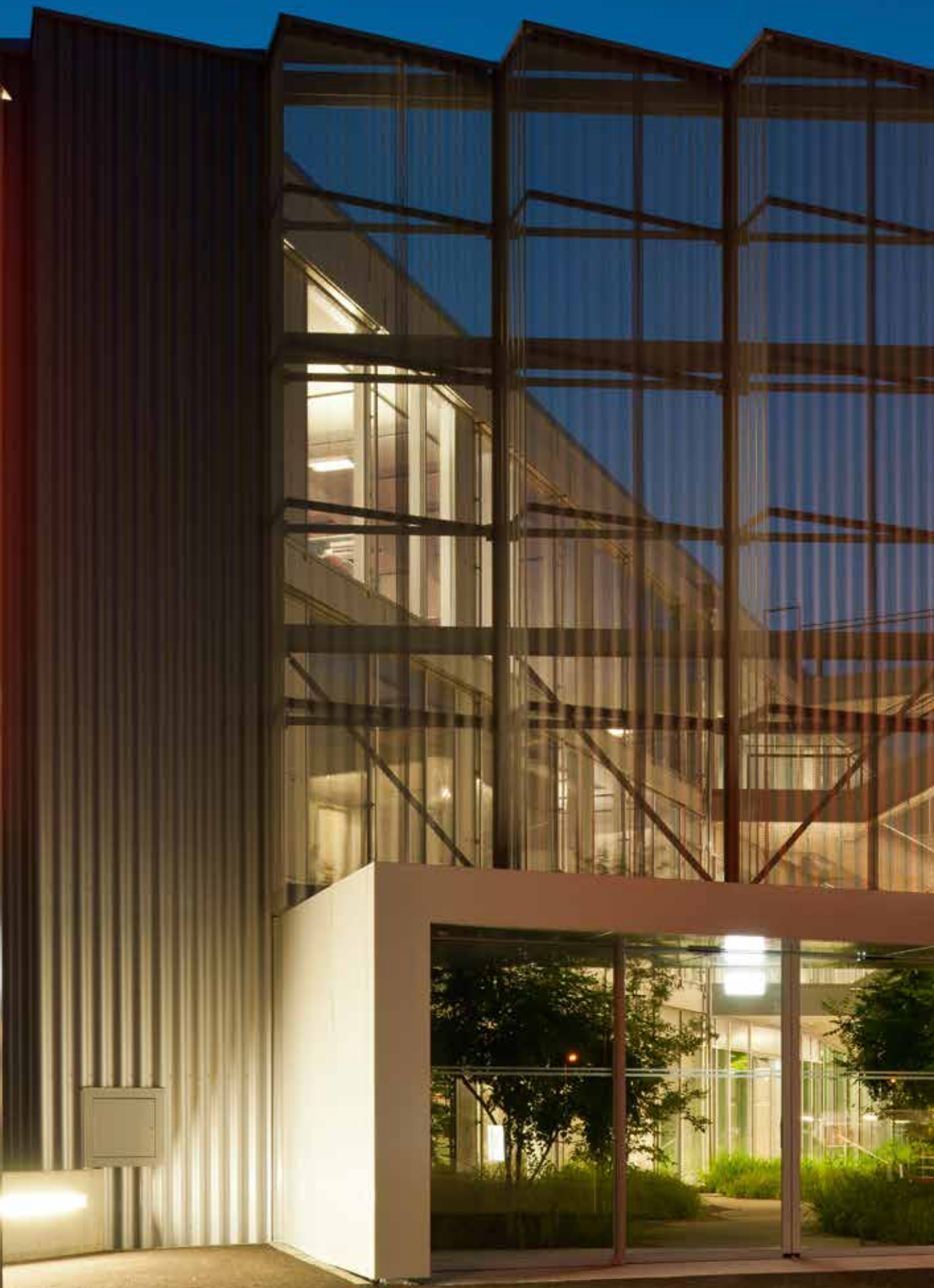

Trafag – Sensors and monitoring instruments for pressure and temperature

Trafag, a Swiss-based company founded in 1942, is supported by a broad sales and service network in over 40 countries across the world. This allows Trafag to offer customers personalised and competent advice and ensures the best possible service. High-performance development and production departments not only guarantee the fast and reliable delivery of our high-quality and high-precision products, but also ensure that customisations can be implemented in a short time.



Competent and customer-oriented

Technological competence, manufacturing expertise and customer-orientation form the three cornerstones of Trafag as a company. Trafag is a completely independent company with headquarters in Bubikon, Switzerland, and further manufacturing companies in Germany and the Czech Republic. A fifth of its employees in Switzerland are involved in the fields of research and development, production technology or applications engineering.

Application and solution-oriented

The direct availability of these resources enables Trafag to be extremely flexible in the areas of development and production as well as in its perception and implementation of customer requirements. Thanks to modular engineering, Trafag is able to efficiently adapt its standard products to the specific needs of customers and to develop special OEM solutions.

Market-oriented and always within reach

Trafag maintains an active presence in over 40 countries. A great number of customers in diverse industrial sectors such as mechanical engineering, hydraulics, engine manufacturing, shipbuilding, railway technology or high-voltage technology appreciate the cooperation offered by our technically competent customer advisory service.

Adaptable and efficient

The ability to develop and manufacture its strategically important components in-house means that Trafag can both mass-produce and manufacture on a small scale at short notice. Rigorous quality management in accordance with ISO 9001, state of the art production facilities under clean room conditions and stringently monitored production processes ensure that Trafag meets the highest quality demands.



Content

Pressure switches and accessories



Trafag pressure transmitters and electronic pressure switches are used for measuring and evaluating pressure. Over the decades, they have proven themselves in a multitude of demanding applications in harsh environments. Superior technology and precise manufacturing ensure that the transmitters work perfectly, especially in areas where high requirements are placed on long-term stability, vibration resistance, electromagnetic compatibility, shock resistance or temperature insensitivity. Trafag pressure transmitters and electronic pressure switches are available in many different designs to suit pressure and electrical connections, measuring procedures, electrical output signals. They are available with Ex- and ship approvals as well as with railway conformity.

Markets and applications	6 - 7
Pressure transmitters technology	8
Information on accessories	9
Overview Pressure transmitter	10 - 15
OEM solutions and sensors	16 - 19
Information on pressure switches and thermostats	20
Data sheets of the pressure transmitters	21 - 198
Accessories	201 - 211
Terminology for pressure measurement instruments	212 - 215
Information on Ex products	216
Fluid resistance guide	217 - 219
Conversion of pressure and temperature units	220 - 221
Address directory Trafag worldwide	222 - 225

Our products are at home where you are



Shipbuilding



- Propulsion
- Pumps
- Ballast water treatment
- Steering
- Separators
- Tank level



Hydraulics



- Construction machinery
- Agricultural machinery
- Injection molding machines
- Community vehicles
- Elevators



Engines



- Common rail injection
- Cooling water
- Oil pressure
- Fuel pressure
- Turbo charger



Railways

- Brake systems
- Pantograph
- Air compressors



Water treatment

- Drinking water
- Waste water
- Desalination
- Pools
- Sluice steering
- Level control



Various

- Chemical industry
- Mining
- Process technology
- Oil and gas
- Machine building industry
- HVAC

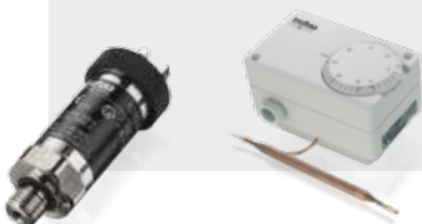

Pressure transmitters

Trafag pressure transmitters and electronic pressure switches are used for measuring and evaluating pressure. Over the decades, they have proven themselves in a multitude of demanding applications in harsh environments. Superior technology and precise manufacturing ensure that the transmitters work perfectly, especially in areas where high requirements are placed on long-term stability, vibration resistance, electromagnetic compatibility, shock resistance or temperature insensitivity. Trafag pressure transmitters and electronic pressure switches are available in many different designs to suit pressure and electrical connections, measuring procedures, electrical output signals. They are available with Ex- and ship approvals as well as with railway conformity.

Technology

Thin-film-on-steel (welded and O-ring free) or thick-film-on-ceramic pressure sensors are key components of Trafag pressure transmitters. Both sensor technologies as well as the ASIC (application-specific microchip) are developed and produced in-house. As a result, compact pressure sensors and electronics work in perfect partnership and achieve a unique level of long-term stability and reliability even under the most adverse environmental conditions. Trafag is a technological pioneer when it comes to miniaturising robust pressure transmitters.



Thin-film-on-steel technology

- Very good long term stability
- Resistant to high media temperatures
- Completely welded stainless steel sensor system without O-rings
- Resistant to very high over pressures and ideal for nominal pressures up to 3000 bar



Thick-film-on-ceramic technology

- Resistant to aggressive media
- Ideal for low pressure ranges and absolute measurement
- Economical

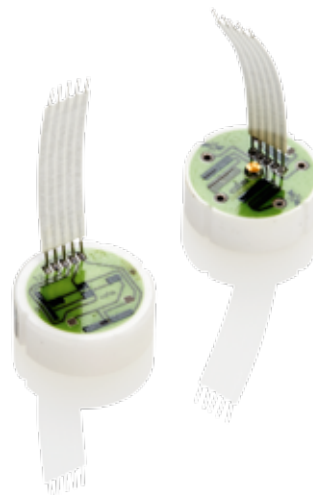

Accessories





Trafag offers a wide range of original accessories which are ideally matched to our products. These include devices for monitoring or configuring transmitters such as hand pumps with precision pressure gauge or the Sensor Communicator, a handheld device which provides direct access to the calibration values of the transmitter in the Trafag ASIC. Trafag also offers a wide range of accessories meet specific application requirements and also make installation easier. They include diagnostic valve manifolds, snubbers and pressure peak damping elements for measuring pressure, or protective pipes for thermostats.

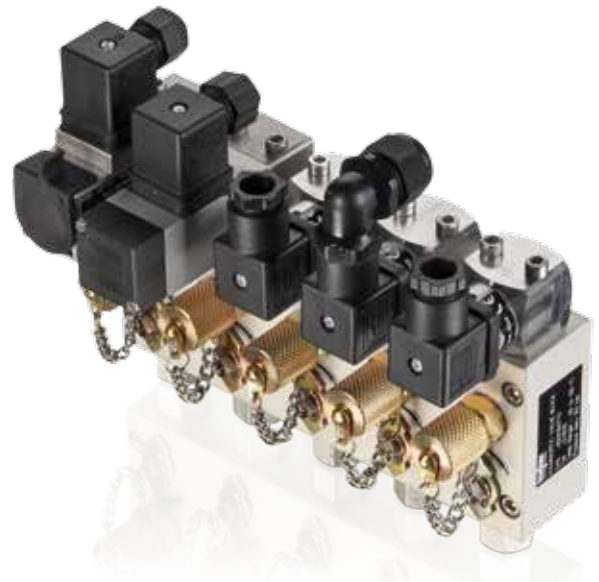







Accessories for pressure measurement instruments

- SMI Sensor Master Interface
- Sensor Communicator
- CAN2USB CANopen Configuration Tool
- DVB Diagnostic Valve Block
- Hand pump with precision manometer
- Switch amplifier
- Venting box
- Cable hanger
- Pressure peak damping element
- Snubber
- Adapters for different pressure connections
- Stop valve





















Overview pressure transmitter

	NAT 8252	NAH 8253	NAH 8254	NAE 8256	NSL 8257
					
	page 21	page 31	page 36	page 46	page 52
Measuring principle	Thin film on steel	Thin film on steel	Thin film on steel	Thin film on steel	Thin film on steel
Measuring range	0 ... 2.5 to 0 ... 600 bar 0 ... 30 to 0 ... 7500 psi	0 ... 2.5 to 0 ... 600 bar 0 ... 30 to 0 ... 7500 psi	0 ... 2.5 to 0 ... 600 bar 0 ... 30 to 0 ... 7500 psi	0 ... 6 to 0 ... 600 bar 0 ... 100 to 0 ... 7500 psi	0 ... 0.2 to 0 ... 2.5 bar 0 ... 3 to 0 ... 30 psi
Output signal	4 ... 20 mA, 0.5 ... 4.5 VDC, 0 ... 5 VDC, 1 ... 5 VDC, 1 ... 6 VDC, 0 ... 10 VDC, 0.1 ... 10.1 VDC, 0.5 ... 4.5 VDC ratiometric, Switching output: 1 or 2 PNP transistors	4 ... 20 mA, 0 ... 5 VDC, 1 ... 6 VDC, 0 ... 10 VDC, 0.5 ... 4.5 VDC ratiometric	4 ... 20 mA, 0.5 ... 4.5 VDC, 0 ... 5 VDC, 1 ... 5 VDC, 1 ... 6 VDC, 0 ... 10 VDC, 0.1 ... 10.1 VDC, 0.5 ... 4.5 VDC ratiometric, Switching output: 1 or 2 PNP transistors	4 ... 20 mA	4 ... 20 mA, 0 ... 5 VDC, 0 ... 10 VDC, 0.5 ... 4.5 VDC ratiometric
Accuracy @ 25°C typ.	± 0.5 % FS typ.	± 0.3 % FS typ. ± 0.15 % FS typ. ± 0.1 % FS typ.	± 0.3 % FS typ.	0.5 %: ± 0.5 % FS typ. 0.3 %: ± 0.3 % FS typ.	0.15 ... 0.8 % FS typ.
Ambient temperature	-40°C ... +125°C	-40°C ... +125°C	-40°C ... +125°C	-40°C ... +125°C	-40°C ... +125°C
Media temperature	-40°C ... +125°C	-40°C ... +125°C	-40°C ... +125°C	-40°C ... +125°C	-40°C ... +125°C
Protection	IP65, IP67	Min. IP65	IP65, IP67	IP65, IP67	Min. IP65
Sensor (wetted parts)	1.4542 (AISI630)	1.4542 (AISI630)	1.4542 (AISI630)	1.4542 (AISI630)	1.4542 (AISI630)
Pressure connection (wetted parts)	1.4542 (AISI630)	1.4542 (AISI630) 1.4301 (AISI304)	1.4542 (AISI630)	1.4542 (AISI630)	1.4542 (AISI630)
Housing	1.4301 (AISI304)	1.4301 (AISI304)	1.4301 (AISI304)	1.4301 (AISI304)	1.4301 (AISI304)
Pressure connections	G1/4" m, G1/4" m (Manometer), 1/4"NPT m, 1/8"NPT m, 7/16"-20UNF SAE J512 f, 7/16"-20UNF SAE4 m, 7/16"-20UNF m DIN3866, R1/4" m DIN3858, R1/4" m DIN2999, R1/8" m, M10x1 m, M12x1.5 m	G1/4" m, 1/4"NPT m, 7/16"-20UNF m, 7/16"-20UNF f (valve opener), 7/16"-20UNF SAE4 m	G1/4" m, G1/4" m (Manometer), 1/4"NPT m, 1/8"NPT m, 7/16"-20UNF SAE J512 f, 7/16"-20UNF SAE4 m, 7/16"-20UNF m DIN3866, R1/4" m DIN3858, R1/4" m DIN2999, R1/8" m, M10x1 m, M12x1.5 m	G1/4" m, G1/4" m (Manometer EN 871), 1/4"NPT m, M10x1 m	G1/4" m, 1/4"NPT m
Electrical connections	Industrial standard, contact distance 9.4 mm; M12x1; MIL-C 26482; cable IP67	Industrial standard, contact distance 9.4 mm; M12x1	Industrial standard, contact distance 9.4 mm; M12x1; MIL-C 26482; cable IP67	Industrial standard, contact distance 9.4 mm; M12x1	Industrial standard, contact distance 9.4 mm; M12x1
Applications	Machine tools Hydraulics HVAC Refrigeration Process technology Water treatment	Machine tools Hydraulics Process technology Water treatment Test benches	Machine tools Hydraulics HVAC Refrigeration Process technology Water treatment	Shipbuilding Engine manufacturing Hydraulics	Shipbuilding Engine manufacturing Machine tools Process technology Water treatment Test benches
Approval / conformity				ABS, BV, DNV-GL, LRS, KRS, NKK, RINA, RMRS	DNV-GL, RINA
Data sheet	www.trafag.com/H72303	www.trafag.com/H72300	www.trafag.com/H72304	www.trafag.com/H72305	www.trafag.com/H72302
Instructions	www.trafag.com/H73303	www.trafag.com/H73250	www.trafag.com/H73303	www.trafag.com/H73303	www.trafag.com/H73250





NAR 8258	 ECT 8472	ECT 0.3 % (0.5 %, 1.0 %) 8473	ECTN 8477	 ECR 8478	 EPI 8287
page 57	page 66	page 73	page 80	page 86	page 92
					
Thin film on steel	Thick film on ceramic	Thick film on ceramic	Thick film on ceramic	Thick film on ceramic	Thin film on steel
0 ... 6 to 0 ... 600 bar 0 ... 100 to 0 ... 7500 psi	0 ... 1 to 0 ... 400 bar 0 ... 15 to 0 ... 5000 psi	0 ... 0.1 to 0 ... 40 bar 0 ... 1.5 to 0 ... 500 psi	0 ... 1 to 0 ... 400 bar 0 ... 15 to 0 ... 5000 psi	0 ... 0.1 to 0 ... 60 bar 0 ... 1.5 to 0 ... 1000 psi	0 ... 2.5 to 0 ... 600 bar 0 ... 30 to 0 ... 7500 psi
4 ... 20 mA, Switching output: 1 or 2 PNP transistors	4 ... 20 mA, 0 ... 5 VDC, 1 ... 6 VDC, 0 ... 10 VDC, 0.5 ... 4.5 VDC ratiom.	4 ... 20 mA, 0 ... 5 VDC, 1 ... 6 VDC, 0 ... 10 VDC, 0.5 ... 4.5 VDC ratiom.	4 ... 20 mA	4 ... 20 mA	4 ... 20 mA, 0 ... 5 VDC, 1 ... 6 VDC, 0 ... 10 VDC, 0.5 ... 4.5 VDC ratiometric
± 0.3 % FS typ.	± 0.5 % FS typ.	± 0.3 % FS typ. (± 0.5 % FS typ., ± 1 % FS typ.)	± 0.5 % FS typ.	± 0.3 % FS typ. (± 0.5 % FS typ., ± 1 % FS typ.)	± 0.5 % FS typ. ± 0.3 % FS typ.
-40°C ... +125°C	-25°C ... +85°C	-25°C ... +85°C	-25°C ... +85°C	-25°C ... +125°C	-40°C ... +125°C
-40°C ... +125°C	-25°C ... +125°C	-25°C ... +125°C	-25°C ... +85°C	-25°C ... +125°C	-40°C ... +125°C
IP65, IP67	IP65, IP67, IP68	IP65, IP67, IP68	min. IP65	IP65, IP67	IP65, IP67, IP68
1.4542 (AISI630)	Ceramic, Al ₂ O ₃ (96 %)	Ceramic, Al ₂ O ₃ (96 %)	Ceramic, Al ₂ O ₃ (96 %)	Ceramic, Al ₂ O ₃ (96 %)	1.4542 (AISI630)
1.4542 (AISI630)	1.4305 (AISI303) 1.4404/1.4435 (AISI316L) 1.4462 (AISI318LN) Titanium Grade 5	1.4305 (AISI303) 1.4404/1.4435 (AISI316L) 1.4462 (AISI318LN) Titanium Grade 5	1.4404/1.4435 (AISI316L) 1.4462 (AISI318LN) Titanium Grade 5	1.4404 (AISI316L)	1.4542 (AISI630) or 1.4404 (AISI316L)
1.4301 (AISI304)	1.4305 (AISI303) 1.4404/1.4435 (AISI316L) 1.4462 (AISI318LN) Titanium Grade 5	1.4305 (AISI303) 1.4404/1.4435 (AISI316L) 1.4462 (AISI318LN) Titanium Grade 5	1.4404/1.4435 (AISI316L) 1.4462 (AISI318LN) Titanium Grade 5	1.4404/1.4435 (AISI316L)	1.4542 (AISI630) or 1.4404 (AISI316L)
G1/4" m, G1/4" m (Manometer), 1/4"NPT m, 1/8"NPT m, 7/16"-20UNF SAE J512 f, 7/16"-20UNF SAE4 m, 7/16"-20UNF m, R1/4" m, R1/8" m, M10x1 m, M12x1.5 m (DIN EN ISO 9974-2)	G1/4" f, G1/4" m, G1/2" m DIN3852-A, G1/2" m DIN3852-E, 1/4"NPT m ANSI B1.20.1, 1/8"NPT m ANSI B1.20.1, 7/16"-20UNF m SAE4, 7/16"-20UNF m, DIN3866, 7/16"-20UNF f SAE J512 with valve opener, R1/4" m DIN3858 G3/4" frontal membrane	G1/4" f, G1/4" m, G1/2" m DIN3852-A, G1/2" m DIN3852-E, 1/4"NPT m ANSI B1.20.1, 1/8"NPT m ANSI B1.20.1, 7/16"-20UNF m SAE4, R1/4" m DIN3858, G3/4" frontal membrane	G1/4" f, G1/4" m, G1/2" m, 1/4"NPT m	G1/4" m, G3/4" frontal membrane	G1/4" f; G1/4" m Seal; G1/2" m (Manometer); 1/4"NPT m; 1/2"NPT m; R1/4" m DIN3858; M14x1.5 m DIN6149-2; 7/16"-20UNF m, DIN3866; 7/16"-20UNF m SAE4 (J1926); 7/16"-20UNF f SAE J512, valve opener
Industrial standard, contact distance 9.4 mm; M12x1	EN175301-803-A (DIN43650-A); M12x1; Industrial standard, contact distance 9.4 mm; Packard Metri Pack; Cable	EN175301-803-A (DIN43650-A); M12x1; Industrial standard, contact distance 9.4 mm; Packard Metri Pack; Cable	EN175301-803-A (DIN43650-A); M12x1; Industrial standard, contact distance 9.4 mm; Cable IP67; Cable IP68	EN175301-803-A (DIN43650-A); M12x1	Industrial standard, contact distance 9.4 mm; M12x1; Packard Metri Pack; cable IP68
Railways	Machine tools Hydraulics Water treatment	Machine tools Hydraulics Water treatment	Shipbuilding Engine manufacturing	Railways	Machine tools Hydraulics Industrial applications
EN 50155 (Railway) EN 45545-2 (Fire protection) EN 61373 (Shock, vibration) EN 50121-3-2 (EMC)			DNV-GL, KRS, RINA	EN 50155 (Railway) EN 45545-2 (Fire protection)	
www.trafag.com/H72307	www.trafag.com/H72324	www.trafag.com/H72326	www.trafag.com/H72322	www.trafag.com/H72337	www.trafag.com/H72317
www.trafag.com/H73303	www.trafag.com/H73324	www.trafag.com/H73324	www.trafag.com/H73324	www.trafag.com/H73324	www.trafag.com/H73317

Overview pressure transmitter









	EPN 8288 	EPN/EPNCR 8298 	EPR 8293 	NPN 8264 	FPT 8235
					
	page 100	page 105	page 111	page 116	page 122
Measuring principle	Thin film on steel	Thin film on steel	Thin film on steel	Thin film on steel	Thin film on steel
Measuring range	0 ... 2.5 to 0 ... 600 bar 0 ... 30 to 0 ... 7500 psi	0 ... 2.5 to 0 ... 2500 bar	0 ... 2.5 to 0 ... 600 bar	0 ... 2.5 to 0 ... 250 bar	0 ... 0.3 to 0 ... 100 bar 0 ... 15 to 0 ... 1500 psi
Output signal	4 ... 20 mA, 0 ... 10 VDC 0.5 ... 4.5 VDC ratiometric 	4 ... 20 mA 0.5 ... 4.5 VDC ratiometric	4 ... 20 mA	4 ... 20 mA	4 ... 20 mA, 0 ... 5 VDC, 1 ... 6 VDC, 0 ... 10 VDC, 0.5 ... 4.5 VDC ratiom.
Accuracy @ 25°C typ.	± 0.5 % FS typ. ± 0.3 % FS typ.	± 0.5 % FS typ. ± 0.3 % FS typ.	± 0.5 % FS typ. ± 0.3 % FS typ.	± 0.5 % FS typ. ± 0.3 % FS typ.	± 0.4 % FS
Ambient temperature	-40°C ... +125°C	-40°C ... +125°C	-40°C ... +125°C	-40°C ... +100°C	-40°C ... +85°C (Cable PVC 22: -5°C ... +60°C)
Media temperature	-40°C ... +125°C	-40°C ... +125°C	-40°C ... +125°C	-40°C ... +100°C	-40°C ... +125°C
Protection	IP65	IP65, IP67, IP69K	IP65, IP67	IP65, IP69K	IP65, IP67, IP68
Sensor (wetted parts)	1.4542 (AISI630)	1.4542 (AISI630)	1.4542 (AISI630)	1.4542 (AISI630)	1.4542 (AISI630)
Pressure connection (wetted parts)	1.4542 (AISI630) or 1.4404 (AISI316L)	1.4542 (AISI630)	1.4542 (AISI630) 1.4301 (AISI304)	1.4542 (AISI630)	1.4542 (AISI630)
Housing	1.4542 (AISI630) or 1.4404 (AISI316L)	1.4301 (AISI304) 1.4542 (AISI630)	1.4301 (AISI304) 1.4542 (AISI630)	1.4301 (AISI304)	1.4301 (AISI304)
Pressure connections	G1/4" m, R1/4" m, G1/2" m (Manom.), 1/4" NPT a, 1/2" NPT a, M14x1.5 a	G1/4" m, R1/4" m, G1/2" m (Manom.), 1/4"NPT m, 1/2"NPT m, M14x1.5 m, M18x1.5 m	G1/4" m, R1/4" m, 1/4"NPT m, 1/2"NPT m	G1/4" f, M10x1 f, G1/8" f	G1/2" m, flush membrane
Electrical connections	Industrial standard EN175301-803A	EN175301-803-A (DIN43650-A); DIN72585; Cable	EN175301-803-A (DIN43650-A)	EN175301-803-A (DIN43650-A); Cable	EN175301-803-A (DIN43650-A); M12x1; Industrial standard, contact distance 9.4 mm; Packard Metri Pack; Cable
Applications	Shipbuilding Engine manufacturing Machine tools Hydraulics	Shipbuilding Engine manufacturing Machine tools	Railways	Shipbuilding Engine manufacturing Railways	Engine manufacturing Machine tools Hydraulics
Approval / conformity		ABS, BV, CCS, DNV-GL, KRS, LRS, NKK, RINA, RMRS	EN 50155 (Railways)	ABS, BV, CCS, DNV-GL, KRS, LRS, NKK, RINA, RMRS	
Data sheet	www.trafag.com/H72318	www.trafag.com/H72312	www.trafag.com/H72311	www.trafag.com/H72313	www.trafag.com/H72316
Instructions	www.trafag.com/H73317	www.trafag.com/H73311	www.trafag.com/H73311	www.trafag.com/H73313	www.trafag.com/H73316

CMP 8270	N 8202	 ND 8204	 EXNT 8292	 EXNA 8854
				
page 127	page 132	page 136	page 140	page 146
Thin film on steel	Thin film on steel	Thin film on steel	Thin film on steel	Piezoresistive
0 ... 0.2 to 0 ... 600 bar	0 ... 1.0 to 0 ... 600 bar	0 ... 1 to 0 ... 16 bar	0 ... 0.4 to 0 ... 2000 bar 0 ... 5 to 0 ... 30000 psi	0 ... 0.1 to 0 ... 1000 bar
Bus protocol CANopen DS404	4 ... 20 mA	4 ... 20 mA (P1-P2)	4 ... 20 mA	4 ... 20 mA
± 0.5 % FS typ. ± 0.15 % FS typ. ± 0.1 % FS typ.	± 0.5 % FS typ.	± 0.8 % FS typ	± 0.5 % FS typ. ± 0.3 % FS typ.	
-40°C ... +125°C	-25°C ... +85°C	-25°C ... +85°C	Max. -40°C ... +120°C	T3: -40°C ... +125°C T4: -40°C ... +85°C T6: -40°C ... +50°C
-50°C ... +135°C	-25°C ... +125°C	-25°C ... +125°C	Max. -40°C ... +120°C	T3: -40°C ... +150°C T4: -40°C ... +100°C T6: -40°C ... +50°C
Min. IP67	Min. IP65	Min. IP65	IP65, IP67	Min. IP65
1.4542 (AISI630)	1.4542 (AISI630)	1.4542 (AISI630)	1.4542 (AISI630), optional hydrogen-compatible steel	1.4435 (AISI316L) or titanium
1.4542 (AISI630) 1.4301 (AISI304)	1.4542 (AISI630)	1.4542 (AISI630)	1.4542 (AISI630) 1.4301 (AISI304) Optional hydrogen-compatible steel	1.4435 (AISI316L) or titanium
1.4301 (AISI304)	AlSi10Mg/ Epoxy coated	AlSi10Mg/ Epoxy coated	1.4301 (AISI304)	1.4435 (AISI316L) or titanium
G1/4" m, 1/4"NPT m, 7/16"-20UNF m, 7/16"-20UNF f (valve opener)	G1/4" f, G1/2" m	G1/4" f	G1/4" m, G1/4" m (Manom.), G1/4" f, G1/2" m, G1/2" m (Manom.), R1/4" m, 1/4"NPT m, M18x1.5 m	1/4" NPT m, 1/2"NPT m, G1/4" f, G1/4" m, G1/2" m, G1/2" m frontal membrane, G1/2" m flush membrane
M12x1	Terminal screw 0.75 ... 2.5 mm ²	Terminal screw 0.75 ... 2.5 mm ²	EN175301-803-A; M12x1; MIL-C 26482; Binder 723; Cable	EN175301-803-A; M12x1; MIL-C 26482; Binder 723; Cable
Engine manufacturing Railways Machine tools	Shipbuilding Engine manufacturing	Shipbuilding Engine manufacturing	Shipbuilding Ex Zones 0, 1, 2 (gas); 20, 21, 22 (dust) and mining	Ex Zone 0, 1, 2 / Gas Ex Zone 20, 21, 22 / Dust
	ABS, BV, CCS, DNV-GL, KRS, LRS, RINA	BV, DNV, RINA	GL, KRS ATEX / IECEx, according to the norm EN/IEC 60079-0/ EN 60079-11/ EN 60079-26/ EN 50303	DNV-GL Ex according to standards, IEC/EN 60079-0/-11/-26, EN 50303
www.trafag.com/H72614	www.trafag.com/H72206	www.trafag.com/H72218	www.trafag.com/H72329	www.trafag.com/H72334
www.trafag.com/H73614	www.trafag.com/H70722	www.trafag.com/H73218	www.trafag.com/H73329	

Overview submersible pressure transmitters

	EXL 8432	EXNAL 8858	ECL 8438	ECL 8439	NAL 8838
					
	page 151	page 156	page 160	page 164	page 170
Measuring principle	Thick film on ceramic	Piezoresistive	Thick film on ceramic	Thick film on ceramic	Piezoresistive
Measuring range	0 ... 0.2 to 0 ... 10 bar	0 ... 0.1 to 0 ... 25 bar	0 ... 0.1 to 0 ... 10 bar	0 ... 0.1 to 0 ... 2.0 bar 0 ... 1.5 to 0 ... 30 psi	0 ... 0.1 to 0 ... 25 bar
Output signal	4 ... 20 mA	4 ... 20 mA	4 ... 20 mA	4 ... 20 mA	4 ... 20 mA 0 ... 10 VDC
Accuracy @ 25°C typ.	± 0.3 % FS typ. ± 0.5 % FS typ.		± 0.3 % FS typ. ± 0.5 % FS typ.	± 0.3 % FS typ. ± 0.5 % FS typ.	
Ambient temperature	T4: -20°C ... +70°C T6: -20°C ... +65°C	T4/T6: -5°C ... +50°C	-25°C ... +80°C (+70°C)	max. -25°C ... +70°C	-5°C ... +50°C
Media temperature	T4: -20°C ... +70°C T6: -20°C ... +65°C	T4/T6: -5°C ... +50°C	-25°C ... +80°C (+70°C)	max. -25°C ... +70°C	-5°C ... +50°C
Protection	IP68 (25 bar; 250m)	Min. IP68	IP68 (25 bar; 250m)	IP68 (2.0 bar/20 m)	Min. IP68
Sensor (wetted parts)	Ceramic, Al ₂ O ₃ (96 %)	1.4435 (AISI316L)	Ceramic, Al ₂ O ₃ (96 %)	Ceramic, Al ₂ O ₃ (96%)	1.4435 (AISI316L)
Pressure connection (wetted parts)	1.4404/1.4435 (AISI316L)	1.4435 (AISI316L) or titanium	1.4404/1.4435 (AISI316L)	1.4404 (AISI316L) or 1.4462 (AISI318LN)	1.4435 (AISI316L) or titanium
Housing	1.4404/1.4435 (AISI316L)	1.4435 (AISI316L) or titanium	1.4404/1.4435 (AISI316L)	1.4404 (AISI316L) or 1.4462 (AISI318LN)	1.4435 (AISI316L) or titanium
Pressure connections	Type 1 f, M 10x1, Type 2 m, M 22x1	Open; Closed; G1/4" m	Type 1 f, M 10x1, Type 2 m, M 22x1		Open, Closed, G1/4" m
Electrical connections	Cable PUR/FEP/PE	Cable PUR/Teflon/PE	Cable PUR/FEP/PE	Cable PUR/Radox/PE	Cable PUR/Teflon/PE
Applications	Ex Zone 0, 1, 2 / Gas Ex Underground Mining	Shipbuilding Ex SEV 11 ATEX 0145 X	Shipbuilding Process technology Water treatment	Process technology Water treatment (wastewater, grey-water, drinking water) Seawater Level of oils and fuels	Shipbuilding Process technology Water treatment
Approval / conformity	GL, KRS Ex ATEX/IECEX, EN 60079-0/ EN 60079-11/EN 60079-26/ EN 50303	GL, KRS	GL, KRS		GL, KRS
Data sheet	www.trafag.com/H72330	www.trafag.com/H72231	www.trafag.com/H72328	www.trafag.com/H72336	www.trafag.com/H72228
Instructions	www.trafag.com/H73329		www.trafag.com/H73328	www.trafag.com/H73336	

Overview electronic pressure switches

EPN-S 8320	 DPC 8380	DPS 8381	DCS 8864	 NAT / NAH 8252 / 8254	NAR 8258	
page 175	page 180	page 187	page 194	page 21 / 36	page 57	
						
Thin film on steel	Thick film on ceramic	Thin film on steel	Thin film on steel	Thin film on steel	Thin film on steel	
0 ... 2.5 to 0 ... 600 bar 0 ... 30 to 0 ... 7500 psi	0 ... 0.2 to 0 ... 100 bar 0 ... 2.5 to 0 ... 1500 psi adjustable 50 ... 100 % FS	0 ... 2.5 to 0 ... 600 bar 0 ... 30 to 0 ... 7500 psi adjustable 50 ... 100 % FS	0 ... 1 to 0 ... 600 bar	0 ... 2.5 to 0 ... 600 bar 0 ... 30 to 0 ... 7500 psi	0 ... 6 to 0 ... 600 bar 0 ... 100 to 0 ... 7500 psi	
Transistor (open source)	4 ... 20 mA, 0 ... 5 VDC, 1 ... 6 VDC, 0 ... 10 VDC, switchable mA or V	4 ... 20 mA, 0 ... 5 VDC, 1 ... 6 VDC, 0 ... 10 VDC, switchable mA or V	4 ... 20 mA, 0 ... 10 VDC 2 Relays, electrically isolated 30W (max. 1A), 36 VAC/ DC	4 ... 20 mA, 0.5 ... 4.5 VDC, 0 ... 5 VDC, 1 ... 5 VDC, 1 ... 6 VDC, 0 ... 10 VDC, 0.1 ... 10.1 VDC, 0.5 ... 4.5 VDC ratiometric, Switching output: 1 or 2 PNP transistors	4 ... 20 mA, Switching output: 1 or 2 PNP transistors	
± 0.5 % FS typ. (Switchpoint)	± 0.5 % FS typ.	± 0.5 % FS typ.	± 0.5 % FS typ.	NAT: ± 0.5 % FS typ. NAH: ± 0.3 % FS typ.	± 0.3 % FS typ.	
Standard: -25°C ... +85°C Option: -40°C ... +125°C	-25°C ... +85°C	-25°C ... +85°C	-25°C ... +80°C (LCD display active -10°C ... +70°C)	-40°C ... +125°C	-40°C ... +125°C	
-40°C ... +125°C	-25°C ... +85°C	-25°C ... +85°C	-25°C ... +125°C	-40°C ... +125°C	-40°C ... +125°C	
IP65 (IP67), IP69K	IP67	IP67	IP65	IP65, IP67	IP65, IP67	
1.4542 (AISI630)	Ceramic, Al ₂ O ₃ (96 %)	1.4542 (AISI630)	1.4542 (AISI630)	1.4542 (AISI630)	1.4542 (AISI630)	
1.4542 (AISI630) 1.4301 (AISI304)	1.4305 (AISI303) 1.4404/1.4435 (AISI316L) 1.4462 (AISI318LN) Titanium Grade 5	1.4542 (AISI630)	1.4542 (AISI630) 1.4404 (AISI316L)	1.4542 (AISI630)	1.4542 (AISI630)	
1.4301 (AISI304)	Zinc based die-casting alloy, nickel plated display housing plastic	Zinc based die-casting alloy, nickel plated display housing plastic	1.4301 (AISI304)	1.4301 (AISI304)	1.4301 (AISI304)	
G1/4" m, 1/4"NPT m, G1/2" m, M14x1.5 m, 1/2"NPT m	G1/4" f, G1/4" m, G1/2" m DIN3852-E, 1/4"NPT m, R1/4" m DIN3858, 7/16"-20UNF m DIN3866, 7/16"-20UNF f SAE J512 valve opener, 7/16"-20UNF f (SAE 4), G3/4" frontal membrane	G1/4" f; G1/4" m Seal; G1/2" m (Manometer); 1/4"NPT m; 1/2"NPT m; R1/4" m DIN3858; M14x1.5 m DIN6149-2; 7/16"-20UNF m, DIN3866; 7/16"-20UNF m SAE4 (J1926); 7/16"-20UNF f SAE J512, valve opener	G1/4" m, G1/4" f, G1/2" m, Flange	G1/4" m, G1/4" m (Manometer), 1/4"NPT m, 1/8"NPT m, 7/16"-20UNF SAE J512 f, 7/16"-20UNF SAE4 m, 7/16"-20UNF m DIN3866, R1/4" m DIN3858, R1/4" m DIN2999, R1/8" m, M10x1 m, M12x1.5 m	G1/4" m, G1/4" m (Manometer), 1/4"NPT m, 1/8"NPT m, 7/16"-20UNF SAE J512 f, 7/16"-20UNF SAE4 m, 7/16"-20UNF m, R1/4" m, R1/8" m, M10x1 m, M12x1.5 m (DIN EN ISO 9974-2)	
EN175301-803-A (DIN43650-A); Cable	Male electrical plug M12x1, 5-pole; Male electrical plug M12x1, 4-pole	Male electrical plug M12x1, 5-pole; Male electrical plug M12x1, 4-pole	M12x1, 8-pole	Industrial standard, contact distance 9.4 mm; M12x1; MIL-C 26482; cable IP67	Industrial standard, contact distance 9.4 mm; M12x1	
Shipbuilding Engine manufacturing Railways Machine tools Hydraulics HVAC	Machine tools HVAC Refrigeration Water treatment Process technology	Machine tools Hydraulics Process technology Industrial applications	Shipbuilding Machine tools Hydraulics Process technology	Machine tools Hydraulics HVAC Refrigeration Process technology Water treatment	Railways	
DNV-GL			DNV-GL		EN 50155 (Railway) EN 45545-2 (Fire protection) EN 61373 (Shock, vibration) EN 50121-3-2 (EMC)	
www.trafag.com/H72333	www.trafag.com/H72320	www.trafag.com/H72321	www.trafag.com/H72605	NAT: www.trafag.com/H72303 NAH: www.trafag.com/H72304	www.trafag.com/H72307	
www.trafag.com/H73333	www.trafag.com/H73320	www.trafag.com/H73320	www.trafag.com/H73605	www.trafag.com/H73303	www.trafag.com/H73303	

Pressure sensors

Pressure sensors provide the basis for the outstanding reliability and durability of Trafag pressure transmitters. Developed and produced by Trafag, these pressure sensors are also available to third parties for special OEM solutions. Trafag pressure sensors lend themselves extremely well to adaptation, providing the basis for seamless integration into OEM applications. Trafag's specialists work together with customers to develop tailor-made solutions. Success is assured by combining professional project management – from drafting the requirements specification right through to start of production – with a team of experienced application engineers.



OEM Pressure sensor 8810



Features

- Thin-film-on-steel sensor technology
- Excellent long-term stability
- Further versions available

Technical Data

Sensor material	1.4542/630
Output signal (10 VDC supply)	1.2 ... 2.8 mV/V
Media temperature	-25°C ... +125°C
Ambient temperature	-25°C ... +100°C

Product description

Range [bar]	Max. working pressure [bar]	U-supply [VDC]	Accuracy NLH (BSL) [± % d.S. typ.]	Range [bar]	Max. working pressure [bar]	U-supply [VDC]	Accuracy NLH (BSL) [± % d.S. typ.]
0 ... 40	80	10 ... 15	0.07	0 ... 400	800	10 ... 15	0.07
0 ... 100	200	10 ... 15	0.07	0 ... 600	1000	10 ... 15	0.07
0 ... 250	500	10 ... 15	0.07				



Data sheet

www.trafag.com/H72205

OEM Pressure sensor 8421



Features

- Thick film on ceramic sensor technology
- Excellent long-term stability

Technical Data

Sensor material	Al ₂ O ₃ , 316L (1.4435, 1.4404)
Output signal (10 VDC supply)	2.3 ... 3.5 mV/V
Media temperature	-25°C ... +125°C
Ambient temperature	-25°C ... +100°C

Product description

Range [bar]	Max. working pressure [bar]	U-supply [VDC]	Accuracy NLH (BSL) [± % d.S. typ.]	Range [bar]	Max. working pressure [bar]	U-supply [VDC]	Accuracy NLH (BSL) [± % d.S. typ.]
0 ... 1.6	3.2	20	0.25	0 ... 25	50	20	0.25
0 ... 4	10	20	0.25	0 ... 40	80	20	0.25
0 ... 6	12	20	0.25	0 ... 60	120	20	0.25
0 ... 10	20	20	0.25	0 ... 100	200	20	0.25
0 ... 16	32	20	0.25				



Data sheet

www.trafag.com/H72233

Transducer 8822



Features

- Thin-film-on-steel sensor technology
- Smallest design
- Excellent long-term stability

Technical Data

Sensor material	1.4542/630
Output signal (ratiometric)	1.7 ... 2 mV/V
Media temperature	-25°C ... +125°C
Ambient temperature	-25°C ... +125°C

Product description

Range [bar]	Max. working pressure [bar]	U-supply [VDC]	Accuracy NLH (BSL) [± % FS typ.]	Range [bar]	Max. working pressure [bar]	U-supply [VDC]	Accuracy NLH (BSL) [± % FS typ.]
0 ... 6	12	10 ... 15	0.5	0 ... 100	200	10 ... 15	0.5
0 ... 10	20	10 ... 15	0.5	0 ... 160	320	10 ... 15	0.5
0 ... 16	32	10 ... 15	0.5	0 ... 250	500	10 ... 15	0.5
0 ... 25	50	10 ... 15	0.5	0 ... 400	800	10 ... 15	0.5
0 ... 40	80	10 ... 15	0.5	0 ... 600	1000	10 ... 15	0.5
0 ... 60	120	10 ... 15	0.5				



Data sheet

www.trafag.com/H72315

Customer specific design for OEMs

If the requirements of an application cannot be met with an existing product, Trafag is able to efficiently adapt its standard products to the specific needs of customers and to develop special OEM solutions. Thanks to their modular design, Trafag products can be efficiently customized to fit seamlessly into the targeted environment, providing the high performance and reliability of all Trafag products which are based on the proprietary sensor technologies.

A team of experienced and highly skilled engineers in development and production guarantees excellent products. An efficient project management minimizes risks and ensures a short time to market.

Tank pressure transmitter with temperature sensor



Features

- For fuel density measurement
- Based on established thick-film-on ceramic technology

Technical Data

Pressure range	-100 ... 900 mbar
Output signal	Digital signal
Electrical connection	PCB connector
Media temperature	-25°C ... +85°C

To determine the fuel density in petrol tanks, the pressure signal from a ceramics sensor element and the signal from an integrated PTC temperature sensor are processed in the Trafag ASIC electronics to calculate the density. The digital output signal is used in a chip-to-chip communication with the control unit. The key advantages of this cost-effective solution are the very compact design and the low project risk due to the use of well-proven sensing elements.

Crank case pressure transmitter



Features

- For low pressure measurement
- Crank case on large diesel engines

Technical Data

Pressure range (relative)	0 ... 124 mbar
Output signal (ratiometric)	0.5 ... 4.5 VDC
Electrical connection	DIN72585
Ambient temperature	-25°C ... +105°C

In large diesel engines the crank case pressure is an important indicator for the condition (wear) of the piston rings of diesel engines. Alternative technologies to detect the wear of piston rings only react after the piston ring is already defective while the small pressure changes give early indication of possible increased wear. A pressure transmitter in this application must withstand harsh conditions in terms of vibration and temperature and must maintain a high accuracy over a long lifetime. Trafag developed a new transmitter based on the well-tried EPN series, but extending the measurement range the thin-film-on-steel technology way beyond state-of-the-art towards low pressure down to 0...124 mbar. Due to the experience and expertise of Trafag in this field, the accuracy of the transmitter is high and stable over a long time in operational conditions.

Transmitter 8 x overpressure safety, 0.3 % accuracy



Features

- For low pressure measurement
- Overpressure max. 80 bar

Technical Data

Temperature range	-40°C ... +125°C
Pressure range (relative)	0 ... 10 bar
Burst pressure min.	300 bar
Accuracy @ +25°C	± 0.3 % FS typ.

In water pump applications extreme pressure peaks often occur and can damage pressure transmitters. To avoid failures due to these pressure peaks, Trafag developed a transmitter with 8x overpressure safety and an accuracy of 0.3 % through extended calibration, selection of sensor elements and using high-performance electronics.

On-board pressure transmitter OPT



Features

- Miniatur pressure transmitter
- Completely welded sensor system
- Stainless steel

Technical Data

Sensor material	1.4542/630
Ambient temperature	-25°C ... +100°C
Sensor temperature max.	-25°C ... +100°C
Output signal (ratiometric)	0.5 ... 4.5 VDC

The on-board transmitter for applications requiring a very compact solution directly applied to the pcb offers a wide media temperature and the excellent long-term stability of the thin-film-on-steel sensor technology. The high overpressure safety and the fully welded design allow the use in critical and very demanding applications.

Pressure and temperature measuring instruments

Pressure switches



Trafag's electromechanical pressure switches provide high vibration resistance and switch point precision in combination with an extremely robust and durable design. This results in switches that can be operated for decades without requiring maintenance, even under harsh conditions. Various designs with bellows, membrane and piston sensors cover a wide variety of pressure ranges, media and load profiles for many different applications. Pressostats are available with Ex- and ship approvals as well as with railway conformity.

Pressure switches



Thermostats

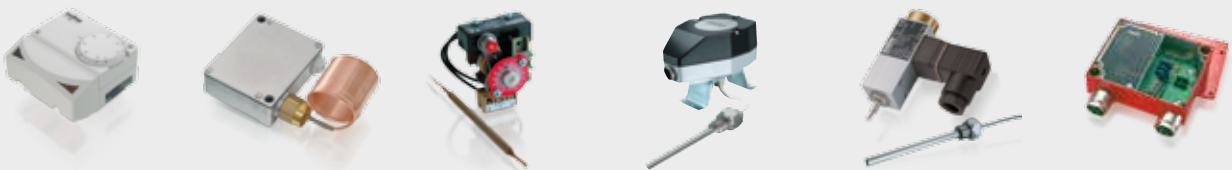

For 70 years Trafag thermostats have proven their robustness in order to withstand the most adverse environmental conditions. Industry usage ranges from air conditioning applications to engine and ship manufacturing and even to offshore oil and gas platform production. The appeal of Trafag thermostats lies in their high switching point precision even after decades of operation under harsh conditions without maintenance. Various sensor and casing designs cover a wide range of temperatures and possible applications. Thermostats are available with Ex- and ship approvals as well as with railway conformity.

Thermostats



INDUSTRIAL PRESSURE TRANSMITTER

Swiss based Trafag is a leading international supplier of high quality sensors and monitoring instruments for measurement of pressure and temperature. The industrial pressure transmitter NAT 8252 features an exceptionally long-term stable thin-film-on-steel sensor cell with triple (optionally 5-fold) overpressure safety. Optionally, the NAT 8252 is available as a pressure switch with 1 or 2 switching outputs. The robust design and the wide temperature range from -40°C to +125°C qualify the NAT 8252 as the ideal solution for a wide range of demanding applications.



Applications

- Machine tools
- Hydraulics
- HVAC
- Refrigeration
- Process technology
- Water treatment

Features

- Smallest design
- Completely welded steel sensor system without additional seals
- Excellent long-term stability
- Optional: fivefold overpressure resistance
- Optional: Switching output 1 or 2 PNP transistors

Technical Data			
Measuring principle	Thin film on steel	Accuracy @ 25°C typ.	± 0.5 % FS typ.
Measuring range	0 ... 2.5 to 0 ... 600 bar 0 ... 30 to 0 ... 7500 psi	Media temperature	-40°C ... +125°C
Output signal	4 ... 20 mA, 0.5 ... 4.5 VDC, 0 ... 5 VDC, 1 ... 5 VDC, 1 ... 6 VDC, 0 ... 10 VDC, 0.1 ... 10.1 VDC, 0.5 ... 4.5 VDC ratiometric, Switching output: 1 or 2 PNP transistors	Ambient temperature	-40°C ... +125°C (Cable PVC 22: -5°C ... +60°C) (Cable PUR 24: -40°C ... +70°C)

Subject to change

Ordering information/type code

				8252 . XX	XX	XX	XX	XX	XX
Measuring range ¹⁾	Pressure measurement range [bar]	Over pressure [bar]	Burst pressure [bar]	Pressure measurement range [psi]	Over pressure [psi]	Burst pressure [psi]			
	0 ... 2.5	7.5	50	75	0 ... 30	90	700	G5	
	0 ... 4	12	60	76	0 ... 50	150	850	G6	
	0 ... 6	18	100	77	0 ... 100	300	1450	G7	
	0 ... 10	30	200	78	0 ... 150	450	2500	G8	
	0 ... 16	48	200	79	0 ... 200	600	2500	GA	
	0 ... 25	75	300	80	0 ... 250	750	2500	G9	
	0 ... 40	120	300	81	0 ... 300	900	4000	HA	
	0 ... 60	180	400	82	0 ... 400	1200	4000	H0	
	0 ... 100	300	500	83	0 ... 500	1500	4000	H1	
	0 ... 160	480	750	85	0 ... 1000	3000	5000	H2	
	0 ... 250	750	1000	74	0 ... 1500	4500	7000	H3	
	0 ... 400	1000	2000	84	0 ... 2000	6000	10000	H5	
	0 ... 600	1500	2500	86	0 ... 3000	9000	14500	G4	
	Option 5P:	Fivefold overpressure			0 ... 5000	12500	21750	H4	
	0 ... 2.5	12.5	60	55	0 ... 7500	18750	29000	H6	
	0 ... 4	20	100	56					
	0 ... 6	30	200	57					
	0 ... 10	50	200	58					
	0 ... 16	80	300	59					
	0 ... 25	125	300	60					
	0 ... 40	200	400	61					
	0 ... 60	300	500	62					
	0 ... 100	500	750	63					
0 ... 160	800	1000	65						
Sensor	Relative pressure						25		
Pressure connection	G1/4" male, seal: DIN 3869 (accessories 61/63/83)						17		
	G1/4" male (Manometer) EN 871 ⁸⁾						53		
	1/4" NPT male						30		
	1/8" NPT male ^{5) 9)}						43		
	7/16"-20UNF female SAE J512 with valve opener ⁴⁾						24		
	7/16"-20UNF female SAE J512 without valve opener ⁴⁾						44		
	7/16"-20UNF male, DIN3866 ⁴⁾						18		
	7/16"-20UNF SAE4 male, seal: accessory 61 ⁸⁾						42		
	R1/4" male, DIN3858 ⁵⁾						19		
	R1/4" male, DIN2999 ^{5) 9)}						20		
	R1/8" male, DIN3858 ⁵⁾						16		
	M10x1 male, DIN EN ISO 6149-2						32		
	M12x1.5 male, DIN EN ISO 9974-2 ⁹⁾						49		
Electrical connection	Male electrical plug, industrial standard, contact distance 9.4 mm, Mat. PA						01		
	Male electrical plug M12x1, 4-pole, Mat. PA						32		
	Male electrical plug M12x1, 5-pole, Mat. PA						35		
	Male electrical plug MIL-C 26482, 6-pole, metal						02		
	Cable IP67, Mat. PVC ⁷⁾						22		
	Cable IP67, Mat. PUR ⁷⁾						24		
	Cable IP67, Mat. EPD Raychem FDR25 ⁷⁾						08		

Output signal	Signal output	Load resistance	I (supply)	U (supply)	
	4 ... 20 mA	See graphic		24 (9 ... 32) VDC	19
	0.5 ... 4.5 VDC	≥ 5.0 kΩ to Us-	≤ 20 mA	24 (9 ... 32) VDC	20
	0 ... 5 VDC	≥ 5.0 kΩ to Us-	≤ 20 mA	24 (9 ... 32) VDC	14
	1 ... 5 VDC	≥ 5.0 kΩ to Us-	≤ 20 mA	24 (9 ... 32) VDC	25
	1 ... 6 VDC	≥ 5.0 kΩ to Us-	≤ 20 mA	24 (9 ... 32) VDC	16
	0 ... 10 VDC	≥ 5.0 kΩ to Us-	≤ 15 mA	24 (15 ... 32) VDC	17
	0.1 ... 10.1 VDC	≥ 5.0 kΩ to Us-	≤ 15 mA	24 (15 ... 32) VDC	13
	0.5 ... 4.5 VDC ratiometric	≥ 5.0 kΩ to Us-	≤ 10 mA	5 (4.75 ... 5.25) VDC	23
	2 PNP transistors ³⁾		≤ 10 mA	24 (9 ... 32) VDC	PS
	1 PNP transistor ³⁾		≤ 10 mA	24 (9 ... 32) VDC	T1
Accessories	Female electrical plug M12x1, 5-pole ²⁾				33
	Female electrical connector industrial standard (for electrical connection 01)				34
	Pressure peak damping element ø 1.0 mm ⁴⁾				40
	Pressure peak damping element ø 0.4 mm ⁴⁾				44
	Seal FPM, -18°C ... +125°C				61
	Seal EPDM, -40°C ... +125°C				63
	Seal NBR, -25°C ... +100°C				83
	Special electrical connection: Pin 2 +, Pin 3 ground, Pin 4 - (only for output signal 19 and male electrical plug 01, industrial standard)				90
	Special electrical connection: Pin 1 out, Pin 2 +, Pin 3 ground, Pin 4 - (only for output signals 14, 16, 17, 23 and male electrical plug 01, industrial standard)				91
	Special electrical connection: Pin 1 +, Pin 2 Ground, Pin 3 Out, Pin 4 - (only for output signals 13, 14, 16, 17, 20, 23, 25 and male electrical plug 32, M12x1, 4-pole)				95
	Special electrical connection: Pin 1 +, Pin 2 Ground, Pin 3 -, Pin 4 Out (only for output signals 14, 16, 17, 23 and male electrical plug 32, M12x1, 4-pole)				96
	Special electrical connection: Pin 1 +, Pin 2 -, Pin 4 ground (only for output signal 19 and male electrical plug 01, industrial standard)				92
	Special electrical connection: Pin 1 +, Pin 2 -, Pin 4 ground (only for output signal 19 and male electrical plug 32, M12x1, 4-pole)				E1
	Special electrical connection: Pin 1 +, Pin 2 -, Pin 3 out, Pin 4 ground (only for output signals 14, 16, 17, 23 and male electrical plug 32, M12x1, 4-pole)				E2
	Special electrical connection: Pin 1 Out, Pin 2 -, Pin 3 +, Pin 4 ground (only for output signals 13, 14, 16, 17, 20, 23, 25 and male electrical plug 01, industrial standard)				E3
	Special electrical connection: Pin 1 +, Pin 2 Ground, Pin 4 - (only for output signal 19 and male electrical plug 32, M12x1, 4-pole)				E6
	Cable length 0.5 m				EM
	Cable length 1.0 m				1M
	Cable length 2.0 m				2M
	Parameterisation according to customer specification for output signal PS, T1 (see table parameter)				ZC

¹⁾ Customized pressure ranges upon request

²⁾ For electrical connections 32 and 35

³⁾ Only with electrical connections 32, 22, 24, 08

⁴⁾ Max. allowable pressure range 60 bar at 120 bar overpressure

⁵⁾ Max. allowable pressure range 160 bar at 500 bar overpressure

⁶⁾ Only for pressure connections 17, 30, 32

⁷⁾ Cable length see accessories

⁸⁾ According to norm J1926, max. 35 MPa

⁹⁾ Upon request

Standard products (extra short lead time)

Product No.	Type Code	Pressure range [bar]	Over pressure max. [bar]	Supply [VDC]	Accuracy @ 25°C typ. [%]
NAT2.5A	8252 75 2517 01 0000 0000 19 34 44 61	0 ... 2.5	7.5	9 ... 32	±0.5
NAT4.0A	8252 76 2517 01 0000 0000 19 34 44 61	0 ... 4	12	9 ... 32	±0.5
NAT6.0A	8252 77 2517 01 0000 0000 19 34 44 61	0 ... 6	18	9...32	±0.5
NAT10.0A	8252 78 2517 01 0000 0000 19 34 44 61	0 ... 10	30	9...32	±0.5
NAT16.0A	8252 79 2517 01 0000 0000 19 34 44 61	0 ... 16	48	9 ... 32	±0.5
NAT25.0A	8252 80 2517 01 0000 0000 19 34 44 61	0 ... 25	75	9 ... 32	±0.5
NAT40.0A	8252 81 2517 01 0000 0000 19 34 44 61	0 ... 40	120	9 ... 32	±0.5
NAT100.0A	8252 83 2517 01 0000 0000 19 34 44 61	0 ... 100	300	9 ... 32	±0.5
NAT250.0A	8252 74 2517 01 0000 0000 19 34 44 61	0 ... 250	750	9 ... 32	±0.5
NAT400.0A	8252 84 2517 01 0000 0000 19 34 44 61	0 ... 400	1000	9 ... 32	±0.5
NAT600.0A	8252 86 2517 01 0000 0000 19 34 44 61	0 ... 600	1500	9 ... 32	±0.5
NAT2.5V	8252 75 2517 01 0000 0000 17 34 44 61	0 ... 2.5	7.5	15 ... 32	±0.5
NAT4.0V	8252 76 2517 01 0000 0000 17 34 44 61	0 ... 4	12	15 ... 32	±0.5
NAT6.0V	8252 77 2517 01 0000 0000 17 34 44 61	0 ... 6	18	15 ... 32	±0.5
NAT10.0V	8252 78 2517 01 0000 0000 17 34 44 61	0 ... 10	30	15 ... 32	±0.5
NAT16.0V	8252 79 2517 01 0000 0000 17 34 44 61	0 ... 16	48	15 ... 32	±0.5
NAT25.0V	8252 80 2517 01 0000 0000 17 34 44 61	0 ... 25	75	15 ... 32	±0.5
NAT40.0V	8252 81 2517 01 0000 0000 17 34 44 61	0 ... 40	120	15 ... 32	±0.5
NAT100.0V	8252 83 2517 01 0000 0000 17 34 44 61	0 ... 100	300	15 ... 32	±0.5
NAT250.0V	8252 74 2517 01 0000 0000 17 34 44 61	0 ... 250	750	15 ... 32	±0.5
NAT400.0V	8252 84 2517 01 0000 0000 17 34 44 61	0 ... 400	1000	15 ... 32	±0.5
NAT600.0V	8252 86 2517 01 0000 0000 17 34 44 61	0 ... 600	1500	15 ... 32	±0.5

Parameter				
Name	Standard setting (accessory ZS)	Value range	Short name	Customer adjustment (accessory ZC)
Switch point SP1 (hysteresis mode) Upper switch point FH1 (window mode)	75 % Measuring range	> RP1, FL1 Hysteresis ≥ 1 % FS	SP1	
Reset point RP1 (hysteresis mode) Lower switch point FL1 (window mode)	25 % Measuring range	< SP1, FH1 Hysteresis ≥ 1 % FS	RP1	
Switch point SP2 (hysteresis mode) Upper switch point FH2 (window mode)	75 % Measuring range	> RP2, FL2 Hysteresis ≥ 1 % FS	SP2	
Reset point RP2 (hysteresis mode) Lower switch point FL2 (window mode)	25 % Measuring range	< SP2, FH2 Hysteresis ≥ 1 % FS	RP2	
Switch point delay time SP1 / RP1 (hysteresis mode) Switch point delay time FH1 / FL1 (window mode)	0	0; 2 ^x [ms], x = 3, 4 ... 16	dS1	
Switch point delay time SP2 / RP2 (hysteresis mode) Switch point delay time FH2 / FL2 (window mode)	0	0; 2 ^x [ms], x = 3, 4 ... 16	dS2	
Functions switching output 1	Hysteresis, closer (Hno)	Hysteresis NO (Hno), Hysteresis NC (Hnc) Window NO (Fno), Window NC (Fnc)	ou1	
Functions switching output 2	Hysteresis, closer (Hno)	Hysteresis NO (Hno), Hysteresis NC (Hnc) Window NO (Fno), Window NC (Fnc) Device ready	ou2	

Parameterization of switching points

The switching points, delay times and output functions can be parameterized via Smartphone app (Android). The SMI Sensor Master Interface required for the parameterization as well as the Smartphone are not part of the delivery. The Android App is available for free in the Google Play Store.

- Ordering No. SMI Sensor Master Interface: F90170 (available from the 2nd quarter of 2018)
- Data sheet SMI Sensor Master Interface: H72618



Specifications		
Electrical Data	Output / supply voltage	4 ... 20 mA: 24 (9...32) VDC 0.5 ... 4.5 VDC: 24 (9...32) VDC 0 ... 5 VDC: 24 (9...32) VDC 1 ... 5 VDC: 24 (9...32) VDC 1 ... 6 VDC: 24 (9...32) VDC 0 ... 10 VDC: 24 (15...32) VDC 0.1 ... 10.1 VDC: 24 (15...32) VDC 0.5 ... 4.5 VDC ratiom., 10 ... 90% U_{supply} : 5 ± 0.25 VDC 1 or 2 PNP transistors: 24 (9...32) VDC
	Rise time	Typ. 1 ms / 10 ... 90 % nominal pressure
	Switch-on-delay pressure transmitters	100 ms
	Switch-on-delay pressure switches	50 ms + switching delay time
	Inverse-polarity protection, short-circuit strenght @ 25°C during 5 min.	4...20 mA: to $U_s = 32$ VDC 0.5...4.5 VDC, 0...5 VDC, 1...5 VDC, 1...6 VDC, 0...10 VDC, 0.1...10.1 VDC: to $U_s = 28$ VDC 0.5...4.5 VDC ratiometric: to $U_s = 14$ VDC 1 or 2 PNP transistors: to $U_s = 32$ VDC
Environmental conditions	Media temperature	-40°C ... +125°C
	Ambient temperature	-40°C ... +125°C (Cable PVC 22: -5°C ... +60°C) (Cable PUR 24: -40°C ... +70°C)
	Protection ¹⁾	IP65, IP67
	Humidity	Max. 95 % relative
	Vibration	15 g RMS (20...2000 Hz) (EN60068-2-64) 25 g sin (80...2000 Hz), 1 oct./min, (1x @ 25°C) (EN60068-2-6)
	Shock	50 g / 11 ms 100 g / 6 ms Male electrical plug M12x1 (EN60068-2-27) ²⁾
EMC Protection	Emission	EN/IEC 61000-6-3
	Immunity	EN/IEC 61000-6-2
Mechanical Data	Sensor (wetted parts)	1.4542 (AISI630)
	Pressure connection (wetted parts)	1.4542 (AISI630)
	Housing	1.4301 (AISI304)
	Sealing	FPM/EPDM/NBR
	Male electrical plug	See ordering information
	Weight	appr. 50 g
	Mounting torque	25 Nm

¹⁾ See electrical connection

²⁾ For electrical connections 32 and 35

Analogue output

Accuracy	TEB @ -25 ... +85°C	[% FS typ.]	± 1.75
	Accuracy @ +25°C	[% FS typ.]	± 0.5
	NLH @ +25°C (BSL)	[% FS typ.]	± 0.2
	TC zero point and span	[% FS/K typ.]	± 0.03
	Long term stability 1 year	[% FS typ.]	± 0.1
Rise time	Typ. 1 ms / 10 ... 90 % nominal pressure		

Switching output

Accuracy	TEB @ -25 ... +85°C	[% FS typ.]	± 1.75
	Accuracy @ +25°C	[% FS typ.]	± 0.5
	Long term stability 1 year	[% FS typ.]	± 0.1
Adjustment range of switchpoints	1 ... 99 % FS		
Distance switch point	≥ 1.0 % FS		
Switch point > reset point	Switchpoint > reset point		
Switching resistance	≤ 3 Ω		
Output function	Hysteresis, Window; normally closed (NO), normally open (NC)		
Switching current	-40°C ... +85°C	(Ambient and media temperature)	≤ 400 mA, total of both switching outputs
	+85°C ... +125°C	(Ambient and media temperature)	≤ 200 mA, total of both switching outputs
Current limiting	integrated		
Delay time	0; 2 ^x [ms], x = 3, 4 ... 16		
Switching frequency	max. 60 Hz (at switching delay time = 0)		

Measuring accuracy

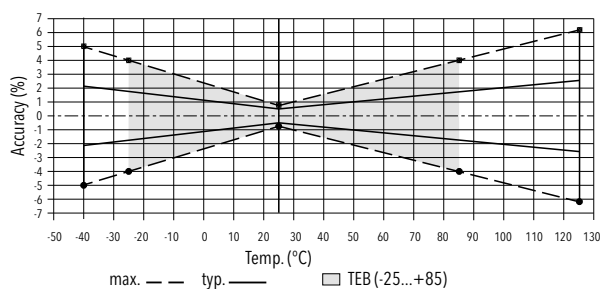

Dimensions

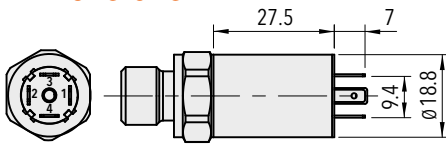

8252.XX.XXXX.01.XX.XX

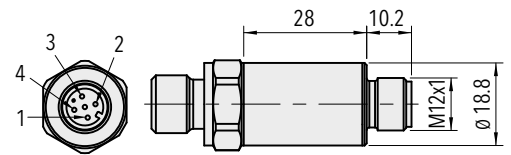

8252.XX.XXXX.32.XX.XX

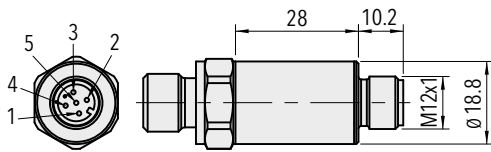

8252.XX.XXXX.35.XX.XX

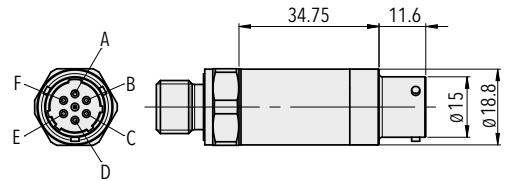

8252.XX.XXXX.02.XX.XX

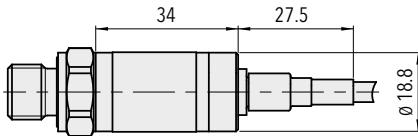

8252.XX.XXXX.22/24/08.XX.XX

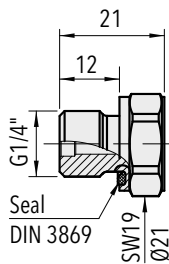

8252.XX.XX17.XX.XX.XX

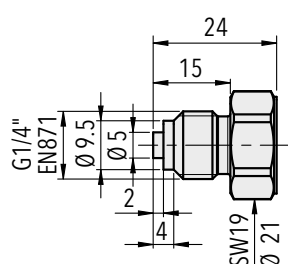

8252.XX.XX53.XX.XX.XX

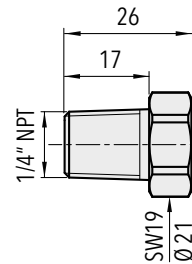

8252.XX.XX30.XX.XX.XX

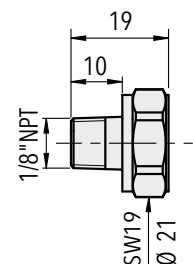

8252.XX.XX43.XX.XX.XX

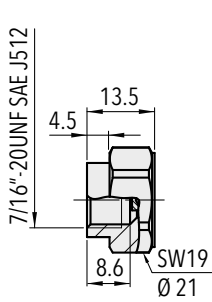

8252.XX.XX24.XX.XX.XX

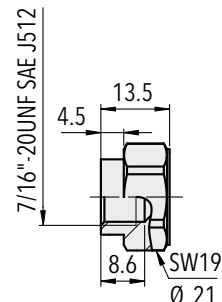

8252.XX.XX44.XX.XX.XX

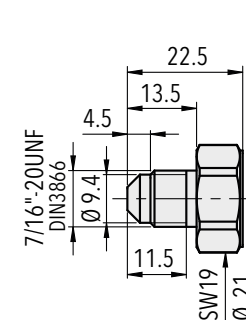

8252.XX.XX18.XX.XX.XX

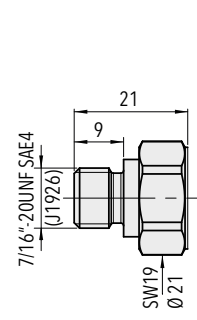

8252.XX.XX42.XX.XX.XX

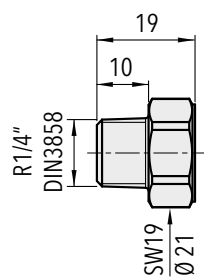

8252.XX.XX19.XX.XX.XX

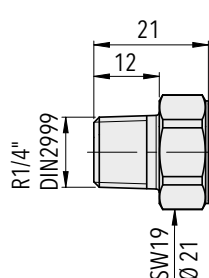

8252.XX.XX20.XX.XX.XX

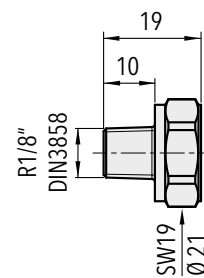

8252.XX.XX16.XX.XX.XX

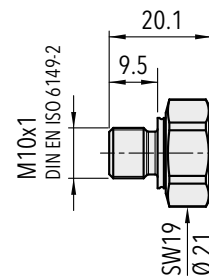

8252.XX.XX32.XX.XX.XX

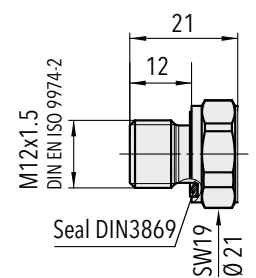

8252.XX.XX49.XX.XX.XX

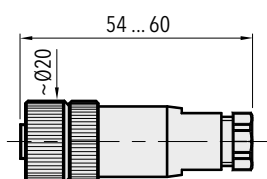

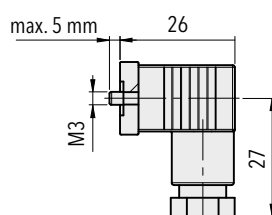

8252.XX.XXXX.XX.XX.33

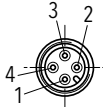
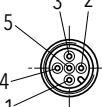

8252.XX.XXXX.XX.XX.34

Electrical connection

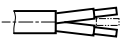
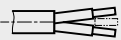
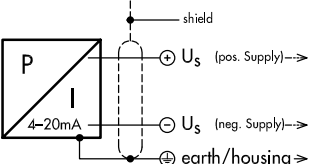
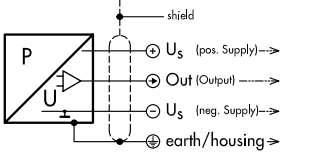
		Protection / electrical connection											
		IP65 *)**)		IP67 *)**)				IP67*)**)		IP67**)			
		Industrial standard Contact distance 9.4 mm		M12x1				MIL-C 26482		Cable			
		01		4-pole 32		5-pole 35		02		22/24		08	
													
Output signal	 <p>8252.XX.XXXX.XX.19</p>	90	92	E1	E6								
		2	2	1	1	1	1	4	A	white	red		
	1	4	2	3	2	4	1	B	brown	black			
	4	3	4	4	4	2	5	E	yellow	green			
Output signal	 <p>8252.XX.XXXXXX.13/14/16/17/20/23/25</p>	91	E3	95	96	E2							
		1	2	3	1	1	1	2		white	red		
	2	1	1	2	3	4	3	4	green	white			
	3	4	2	3	4	3	2	3	brown	black			
	4	3	4	4	2	4	5	5	yellow	green			

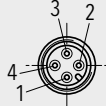
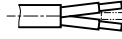
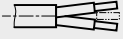
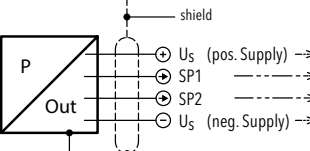
		Protection / electrical connection					
		IP67 *)**)		IP67**)		IP67**)	
		M12x1 4-pole		Cable		Cable	
		32		22/24		08	
							
Output signal	 <p>8252.XX.XXXX.XX.PS/T1</p>	PS	T1	PS	T1	PS	T1
		1	1	white	white	red	red
	4	4	green	green	white	white	
	2	-	yellow	-	green	green	
	3	3	brown	brown	black	black	

*) Provided female connector is mounted according to instructions

**) Ventilation via male electric plug/cable end

4...20mA: min./max resistor vs. supply voltage @ Pmax = 100%

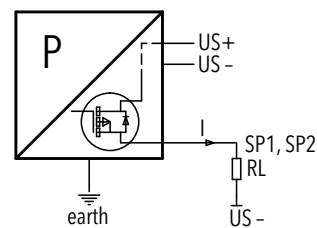
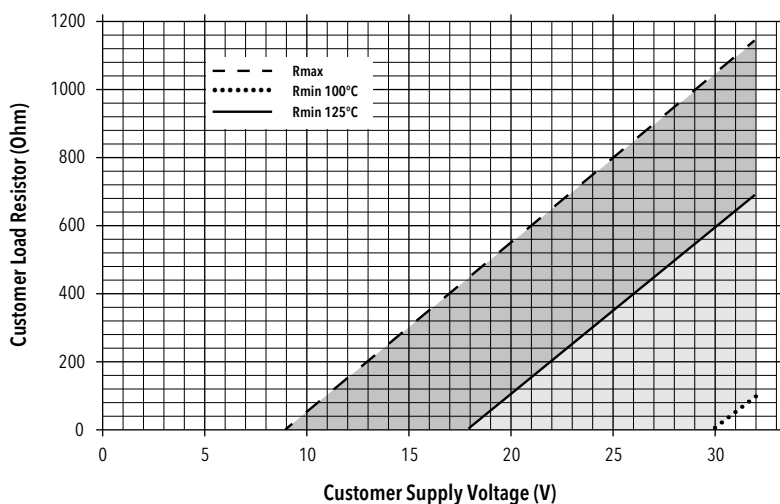

Connection of loads to switch contacts

Functions switching output

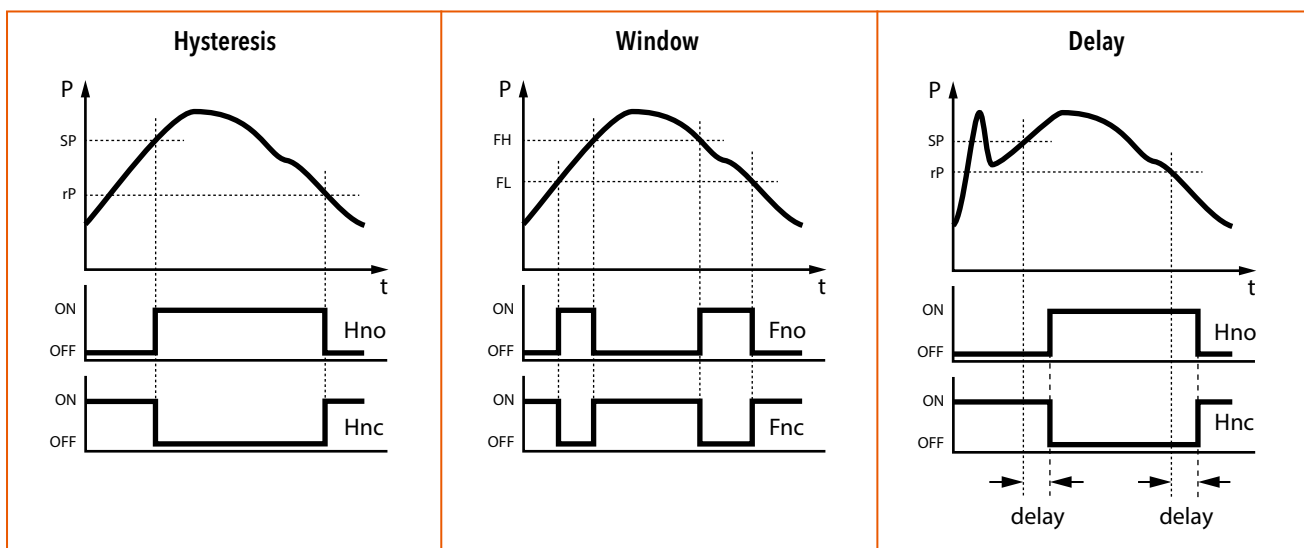

Additional information

Documents

Data sheet	www.trafag.com/H72303
Instructions	www.trafag.com/H73303
Flyer	www.trafag.com/H70666

HYDRAULIC PRESSURE TRANSMITTER

New generation available - refer to www.trafag.com/H72304

Swiss based Trafag is a leading international supplier of high quality sensors and monitoring instruments for measurement of pressure and temperature.



Applications

- Machine tools
- Hydraulics
- Process technology
- Water treatment
- Test benches

Features

- Smallest design
- Accuracy classes 0.1%, 0.3%
- Excellent temperature resistance
- Improved vibration resistance
- Completely welded steel sensor system without additional seals

Technical Data			
Measuring principle	Thin film on steel	Accuracy @ 25°C typ.	± 0.3 % FS typ. ± 0.15 % FS typ. ± 0.1 % FS typ.
Measuring range	0 ... 2.5 to 0 ... 600 bar 0 ... 30 to 0 ... 7500 psi	Media temperature	-40°C ... +125°C
Output signal	4 ... 20 mA, 0 ... 5 VDC, 1 ... 6 VDC, 0 ... 10 VDC, 0.5 ... 4.5 VDC ratiometric	Ambient temperature	-40°C ... +125°C

Subject to change

Ordering information/type code

Measuring range ¹⁾	Pressure measurement range [bar]	Over pressure [bar]	Burst pressure [bar]	Pressure measurement range [psi]	Over pressure [psi]	Burst pressure [psi]	8253 . XX	XX	XX	XX	XX	XX		
		0 ... 2.5 ²⁾	5	50	0 ... 30	60	700	G5						
	0 ... 4	8	60	0 ... 50	100	850	G6							
	0 ... 6	12	100	0 ... 100	200	1450	G7							
	0 ... 10	20	200	0 ... 150	300	2500	G8							
	0 ... 16	32	200	0 ... 200	400	2500	GA							
	0 ... 25	50	300	0 ... 250	500	2500	G9							
	0 ... 40	80	300	0 ... 300	600	4000	HA							
	0 ... 60	120	400	0 ... 400	800	4000	H0							
	0 ... 100	200	500	0 ... 500	1000	4000	H1							
	0 ... 160	320	750	0 ... 1000	2000	5000	H2							
	0 ... 250	500	1000	0 ... 1500	3000	7000	H3							
	0 ... 400	800	1500	0 ... 2000	4000	10000	H5							
	0 ... 600	1000	2000	0 ... 3000	6000	14500	G4							
				0 ... 5000	10000	21750	H4							
				0 ... 7500	15000	29000	H6							
Sensor	Relative pressure, accuracy: 0.3 %							23						
	Relative pressure, accuracy: 0.15 %							21						
	Relative pressure, accuracy: 0.1 %							24						
	Absolute pressure, accuracy: 0.3 %							43						
	Absolute pressure, accuracy: 0.15 %							41						
	Absolute pressure, accuracy: 0.1 %							44						
Pressure connection	G1/4" male (Seal)								17					
	1/4" NPT male								30					
	7/16"-20UNF male ^{3) 4)}								18					
	7/16"-20UNF female, DIN3866 (valve opener) ^{3) 4)}								24					
	7/16"-20UNF male SAE4 ⁷⁾								42					
Electrical connection	Male electrical plug, industrial standard (contact distance 9.4 mm), Mat. PBT										01			
	Male electrical plug M12x1, 4-pole, Mat. PBT										32			
	Male electrical plug M12x1, 5-pole, Mat. PBT										35			
Output signal	Signal output	Load resistance		I (supply)		U (supply)								
	4 ... 20 mA	(U _{supply} -9 V) / 20 mA				24 (9 ... 32) VDC					19			
	0 ... 5 VDC	≥ 2.0 kΩ		≤ 10 mA		24 (9 ... 32) VDC					14			
	1 ... 6 VDC	≥ 2.0 kΩ		≤ 10 mA		24 (9 ... 32) VDC					16			
	0 ... 10 VDC	≥ 5.0 kΩ		≤ 10 mA		24 (15 ... 32) VDC					17			
0.5 ... 4.5 VDC	≥ 2.0 kΩ		≤ 10 mA		5 (4.5 ... 5.5) VDC ratiom.					23				
Accessories	Female electrical plug M12x1, 5-pole, for electrical connections 32 and 35												33	
	Female electrical connector industrial standard													34
	Meets EN50155 (railways) dielectrical strength: 500 VAC, 50 Hz ⁵⁾													11
	Pressure peak damping element ø 1.0 mm ⁶⁾													40
	Pressure peak damping element ø 0.3 mm ⁶⁾													43
	Pressure peak damping element ø 0.5 mm ⁶⁾													45
	Special electrical connection: Pin 1 +, Pin 2 Ground, Pin 3 -, Pin 4 Out (only for output signals 14, 16, 17, 23 and male electrical plug 32, M12x1, 4-pole)													96

¹⁾ Extended overpressure as well as customized pressure ranges upon request

²⁾ Measuring accuracy 0.3 %

³⁾ Relative pressure only

⁴⁾ Max. allowable pressure range 40 bar

⁵⁾ Only with output 19

⁶⁾ Only for pressure connections 17 and 30

⁷⁾ According to norm J1926, max. 35 MPa



Identical construction with higher/lower specifications:
Data sheet No. H72250, H72301

Dimensions

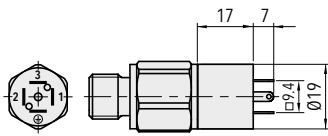

8253.XX.XXXX.01.XX.XX

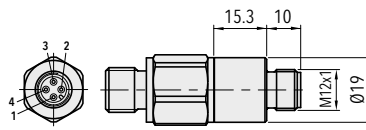

8253.XX.XXXX.32.XX.XX

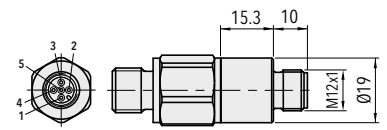

8253.XX.XXXX.35.XX.XX

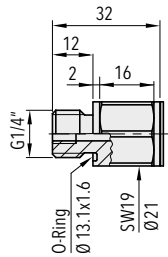

8253.XX.2317.XX.XX.XX
8253.XX.2117.XX.XX.XX

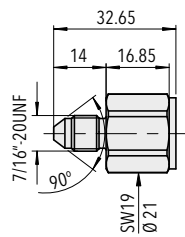

8253.XX.2318.XX.XX.XX
8253.XX.2118.XX.XX.XX

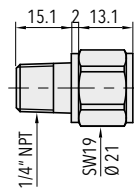

8253.XX.2330.XX.XX.XX
8253.XX.2130.XX.XX.XX

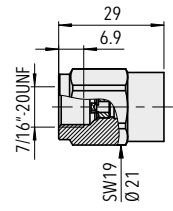

8253.XX.2324.XX.XX.XX
8253.XX.2124.XX.XX.XX

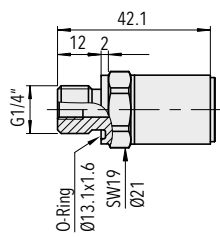

8253.XX.4317.XX.XX.XX
8253.XX.4117.XX.XX.XX

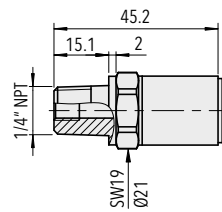

8253.XX.4330.XX.XX.XX
8253.XX.4130.XX.XX.XX

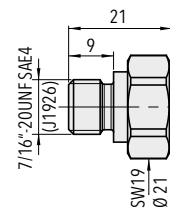

8253.XX.XX42.XX.XX.XX

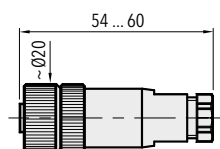

8253.XX.XXXX.XX.XX.33

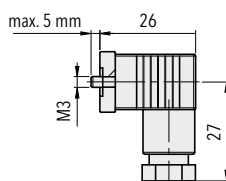

8253.XX.XXXX.XX.XX.34

Specifications		
Electrical Data	Output / supply voltage	4 ... 20 mA: 24 (9 ... 32) VDC 0 ... 5 VDC: 24 (9 ... 32) VDC 1 ... 6 VDC: 24 (9 ... 32) VDC 0 ... 10 VDC: 24 (15 ... 32) VDC 0.5 ... 4.5 VDC: 5 VDC ratiom.
	Rise time	Typ. 1 ms / 10 ... 90 % nominal pressure
	Switch-on-delay	1 s
Environmental conditions	Media temperature	-40°C ... +125°C
	Ambient temperature	-40°C ... +125°C
	Protection ¹⁾	Min. IP65
	Humidity	Max. 95 % relative
	Vibration	40 g (20...2000 Hz)
	Shock	100 g / 11 ms
EMC Protection	Emission	EN/IEC 61000-6-4
	Immunity	EN/IEC 61000-6-2
Mechanical Data	Sensor (wetted parts)	1.4542 (AISI630)
	Pressure connection (wetted parts)	Pressure ranges ≤ 250 bar: 1.4542 (AISI630) Pressure ranges > 250 bar: 1.4301 (AISI304)
	Housing	1.4301 (AISI304)
	Sealing	FKM 70 Sh
	Male electrical plug	See ordering information
	Weight	~ 50 g
	Mounting torque	25 Nm

¹⁾ See electrical connection

Accuracy				
		Measuring accuracy 0.3 % Ordering No. 23/43	Measuring accuracy 0.15 % Ordering No. 21/41	Measuring accuracy 0.1 % Ordering No. 24/44
TEB @ -25...+85°C	[% FS typ.]	± 1.0	± 0.5	± 0.4 (0 ... 65°C)
TEB @ -25...+85°C; 0...4 to 0...100 bar	[% FS typ.]	-	-	± 0.4
TEB @ 0...+65°C; 0...4 to 0...100 bar	[% FS typ.]	-	-	± 0.25
Accuracy @ +25°C	[% FS typ.]	± 0.3	± 0.15	± 0.1
NLH @ +25°C (BSL)	[% FS typ.]	± 0.2	± 0.1	± 0.1
TC zero point and span	[% FS/K typ.]	± 0.01	± 0.002	± 0.002
Long term stability 1 year @ +25°C	[% FS typ.]	< ± 0.1	< ± 0.1	< ± 0.1

Measuring accuracy 0.3 %

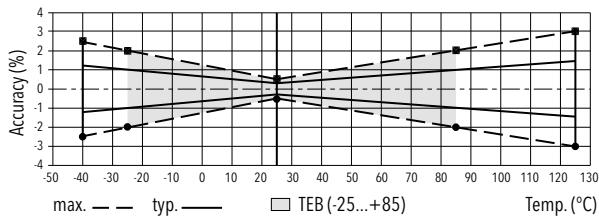

Measuring accuracy 0.15 %

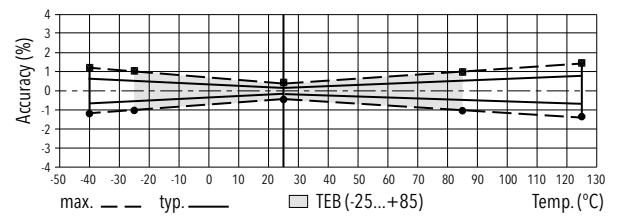

Electrical Connection

		Protection / electrical connection			
		IP65*)	IP67*)		
		Industrial standard EN175301-803A	M12x1		
		01	4-pole 32	96	5-pole 35
Output signal	<p>shield</p> <p>U_S (pos. Supply) →</p> <p>U_S (neg. Supply) →</p> <p>earth/housing →</p> <p>8253.XX.XXXX.XX.19</p>	2	1	-	4
	<p>shield</p> <p>U_S (pos. Supply) →</p> <p>Out (Output) →</p> <p>U_S (neg. Supply) →</p> <p>earth/housing →</p> <p>8253.XX.XXXX.XX.14/16/17/23</p>	1	1	1	2
		1	3	-	1
		⊖	4	-	5
			4	3	3
			⊖	2	5

*) Provided female connector is mounted according to instructions

Additional information

Documents

Data sheet	www.trafag.com/H72300
Instructions	www.trafag.com/H73250
Flyer	www.trafag.com/H70670

HYDRAULIC PRESSURE TRANSMITTER

Swiss based Trafag is a leading international supplier of high quality sensors and monitoring instruments for measurement of pressure and temperature. The hydraulic pressure transmitter NAH 8254 with increased accuracy of 0.3% and optional switching outputs has an exceptionally long-term stable thin-film-on-steel sensor cell with triple (optionally 5-fold) overpressure protection. The robust design and the wide temperature range of -40°C to +125°C make the NAH 8254 the ideal solution when pressure needs to be measured accurately and reliably under rough environmental conditions.



Applications

- Machine tools
- Hydraulics
- HVAC
- Refrigeration
- Process technology
- Water treatment

Features

- Measuring accuracy 0.3 %
- Completely welded steel sensor system without additional seals
- Excellent long-term stability
- Optional: 5-fold overpressure resistance
- Optional: Switching output 1 or 2 PNP transistors

Technical Data			
Measuring principle	Thin film on steel	Accuracy @ 25°C typ.	± 0.3 % FS typ.
Measuring range	0 ... 2.5 to 0 ... 600 bar 0 ... 30 to 0 ... 7500 psi	Media temperature	-40°C ... +125°C
Output signal	4 ... 20 mA, 0.5 ... 4.5 VDC, 0 ... 5 VDC, 1 ... 5 VDC, 1 ... 6 VDC, 0 ... 10 VDC, 0.1 ... 10.1 VDC, 0.5 ... 4.5 VDC ratiometric, Switching output: 1 or 2 PNP transistors	Ambient temperature	-40°C ... +125°C (Cable PVC 22: -5°C ... +60°C) (Cable PUR 24: -40°C ... +70°C)

Subject to change

Ordering information/type code

				8254 . XX	XX	XX	XX	XX	XX
Measuring range ¹⁾	Pressure measurement range [bar]	Over pressure [bar]	Burst pressure [bar]	Pressure measurement range [psi]	Over pressure [psi]	Burst pressure [psi]			
	0 ... 2.5	7.5	50	75	0 ... 30	90	700	G5	
	0 ... 4	12	60	76	0 ... 50	150	850	G6	
	0 ... 6	18	100	77	0 ... 100	300	1450	G7	
	0 ... 10	30	200	78	0 ... 150	450	2500	G8	
	0 ... 16	48	200	79	0 ... 200	600	2500	GA	
	0 ... 25 ⁸⁾	75	300	80	0 ... 250	750	2500	G9	
	0 ... 40 ⁸⁾	120	300	81	0 ... 300 ⁸⁾	900	4000	HA	
	0 ... 60 ⁸⁾	180	400	82	0 ... 400 ⁸⁾	1200	4000	HO	
	0 ... 100 ⁸⁾	300	500	83	0 ... 500	1500	4000	H1	
	0 ... 160 ⁸⁾	480	750	85	0 ... 1000 ⁸⁾	3000	5000	H2	
	0 ... 250	750	1000	74	0 ... 1500 ⁸⁾	4500	7000	H3	
	0 ... 400	1000	2000	84	0 ... 2000 ⁸⁾	6000	10000	H5	
	0 ... 600	1500	2500	86	0 ... 3000	9000	14500	G4	
	Option 5P:	Fivefold overpressure			0 ... 5000	12500	21750	H4	
	0 ... 2.5	12.5	60	55	0 ... 7500	18750	29000	H6	
	0 ... 4	20	100	56					
	0 ... 6	30	200	57					
	0 ... 10	50	200	58					
	0 ... 16	80	300	59					
	0 ... 25	125	300	60					
	0 ... 40	200	400	61					
	0 ... 60	300	500	62					
	0 ... 100	500	750	63					
	0 ... 160	800	1000	65					
	Sensor	Relative pressure, accuracy: 0.3 %						23	
Pressure connection	G1/4" male, seal: DIN 3869 (accessory 61/63/83)						17		
	G1/4" male (Manometer) EN 871 ⁸⁾						53		
	1/4" NPT male						30		
	1/8" NPT male ^{5) 9)}						43		
	7/16"-20UNF female SAE J512 with valve opener ⁴⁾						24		
	7/16"-20UNF female SAE J512 without valve opener ⁴⁾						44		
	7/16"-20UNF male, DIN3866 ⁴⁾						18		
	7/16"-20UNF SAE4 male, seal: accessory 61 ⁷⁾						42		
	R1/4" male, DIN3858 ⁵⁾						19		
	R1/4" male, DIN2999 ^{5) 9)}						20		
	R1/8" male, DIN3858 ⁵⁾						16		
	M10x1 male, DIN EN ISO 6149-2						32		
	M12x1.5 male, DIN EN ISO 9974-2 ⁸⁾						49		
Electrical connection	Male electrical plug, industrial standard, contact distance 9.4 mm, Mat. PA						01		
	Male electrical plug M12x1, 4-pole, Mat. PA						32		
	Male electrical plug M12x1, 5-pole, Mat. PA						35		
	Male electrical plug: MIL-C 26482, 6-pole, metal						02		
	Cable IP67, Mat. PVC ⁷⁾						22		
	Cable IP67, Mat. PUR ⁷⁾						24		
	Cable IP67, Mat. EPD Raychem FDR25 ⁷⁾						08		

Output signal	Signal output	Load resistance	I (supply)	U (supply)	
	4 ... 20 mA	See graphic		24 (9 ... 32) VDC	19
	0.5 ... 4.5 VDC	≥ 5.0 kΩ to Us-	≤ 20 mA	24 (9 ... 32) VDC	20
	0 ... 5 VDC	≥ 5.0 kΩ to Us-	≤ 20 mA	24 (9 ... 32) VDC	14
	1 ... 5 VDC	≥ 5.0 kΩ to Us-	≤ 20 mA	24 (9 ... 32) VDC	25
	1 ... 6 VDC	≥ 5.0 kΩ to Us-	≤ 20 mA	24 (9 ... 32) VDC	16
	0 ... 10 VDC	≥ 5.0 kΩ to Us-	≤ 15 mA	24 (15 ... 32) VDC	17
	0.1 ... 10.1 VDC	≥ 5.0 kΩ to Us-	≤ 15 mA	24 (15 ... 32) VDC	13
	0.5 ... 4.5 VDC ratiom.	≥ 5.0 kΩ to Us-	≤ 10 mA	5 (4.75 ... 5.25) VDC	23
	2 PNP transistors ³⁾		≤ 10 mA	24 (9 ... 32) VDC	PS
	1 PNP transistor ³⁾		≤ 10 mA	24 (9 ... 32) VDC	T1
Accessories					33
	Female electrical plug M12x1, 5-pole ²⁾				33
	Female electrical connector industrial standard (for electrical connection 01)				34
	Pressure peak damping element ø 1.0 mm ⁴⁾				40
	Pressure peak damping element ø 0.4 mm ⁴⁾				44
	Seal FPM, -18°C ... +125°C				61
	Seal EPDM, -40°C ... +125°C				63
	Seal NBR, -25°C ... +100°C				83
	Special electrical connection: Pin 2 +, Pin 3 ground, Pin 4 - (only for output signal 19 and male electrical plug 01, industrial standard)				90
	Special electrical connection: Pin 1 out, Pin 2 +, Pin 3 ground, Pin 4 - (only for output signals 14, 16, 17, 23 and male electrical plug 01, industrial standard)				91
	Special electrical connection: Pin 1 +, Pin 2 Ground, Pin 3 Out, Pin 4 - (only for output signals 13, 14, 16, 17, 20, 23, 25 and male electrical plug 32, M12x1, 4-pole)				95
	Special electrical connection: Pin 1 +, Pin 2 Ground, Pin 3 -, Pin 4 Out (only for output signals 14, 16, 17, 23 and male electrical plug 32, M12x1, 4-pole)				96
	Special electrical connection: Pin 1 +, Pin 2 -, Pin 4 ground (only for output signal 19 and male electrical plug 01, industrial standard)				92
	Special electrical connection: Pin 1 +, Pin 2 -, Pin 4 ground (only for output signal 19 and male electrical plug 32, M12x1, 4-pole)				E1
	Special electrical connection: Pin 1 +, Pin 2 -, Pin 3 out, Pin 4 ground (only for output signals 14, 16, 17, 23 and male electrical plug 32, M12x1, 4-pole)				E2
	Special electrical connection: Pin 1 Out, Pin 2 -, Pin 3 +, Pin 4 ground (only for output signals 13, 14, 16, 17, 20, 23, 25 and male electrical plug 01, industrial standard)				E3
	Special electrical connection: Pin 1 +, Pin 2 Ground, Pin 4 - (only for output signal 19 and male electrical plug 32, M12x1, 4-pole)				E6
	Cable length 0.5 m				EM
	Cable length 1.0 m				1M
	Cable length 2.0 m				2M
	Parameterisation according to customer specification for output signal PS, T1 (see table parameter)				ZC
	Signal processing, cut-off frequency (see table Signal processing)				

¹⁾ Customized pressure ranges upon request

²⁾ For electrical connections 32 and 35

³⁾ Only with electrical connections 32, 22, 24, 08

⁴⁾ Max. allowable pressure range 60 bar at 120 bar overpressure

⁵⁾ Max. allowable pressure range 160 bar at 500 bar overpressure

⁶⁾ Only for pressure connections 17, 30, 32

⁷⁾ Cable length see accessories

⁸⁾ According to norm J1926, max. 35 MPa

⁹⁾ Upon request

¹⁰⁾ Only with electrical connections 32, 35 with shielded cable and 22, 24, 08

Signal processing, 4 ... 20 mA, 0.5 ... 4.5 VDC ratiometric		
Code	Cut-off frequency f_G	Rise time (10 ... 90 % nominal pressure)
GA ⁹⁾	11 Hz	32 ms
GU ^{9) 10)}	20 kHz	18 μs

Standard products (extra short lead time)

Product No.	Type Code	Pressure range [bar]	Over pressure max. [bar]	Supply [VDC]	Accuracy @ 25°C typ. [%]
NAH2.5A	8254 75 2317 32 0000 0000 19 33 44 61	0 ... 2.5	7.5	9 ... 32	± 0.3
NAH4.0A	8254 76 2317 32 0000 0000 19 33 44 61	0 ... 4	12	9 ... 32	± 0.3
NAH6.0A	8254 77 2317 32 0000 0000 19 33 44 61	0 ... 6	18	9 ... 32	± 0.3
NAH10.0A	8254 78 2317 32 0000 0000 19 33 44 61	0 ... 10	30	9 ... 32	± 0.3
NAH16.0A	8254 79 2317 32 0000 0000 19 33 44 61	0 ... 16	48	9 ... 32	± 0.3
NAH25.0A	8254 80 2317 32 0000 0000 19 33 44 61	0 ... 25	75	9 ... 32	± 0.3
NAH40.0A	8254 81 2317 32 0000 0000 19 33 44 61	0 ... 40	120	9 ... 32	± 0.3
NAH100.0A	8254 83 2317 32 0000 0000 19 33 44 61	0 ... 100	300	9 ... 32	± 0.3
NAH250.0A	8254 74 2317 32 0000 0000 19 33 44 61	0 ... 250	750	9 ... 32	± 0.3
NAH400.0A	8254 84 2317 32 0000 0000 19 33 44 61	0 ... 400	1000	9 ... 32	± 0.3
NAH600.0A	8254 86 2317 32 0000 0000 19 33 44 61	0 ... 600	1500	9 ... 32	± 0.3

Parameter				
Name	Standard setting (accessory ZS)	Value range	Short name	Customer adjustment (accessory ZC)
Switch point SP1 (hysteresis mode) Upper switch point FH1 (window mode)	75 % Measuring range	> RP1, FL1 Hysteresis \geq 1 % FS	SP1	
Reset point RP1 (hysteresis mode) Lower switch point FL1 (window mode)	25 % Measuring range	< SP1, FH1 Hysteresis \geq 1 % FS	RP1	
Switch point SP2 (hysteresis mode) Upper switch point FH2 (window mode)	75 % Measuring range	> RP2, FL2 Hysteresis \geq 1 % FS	SP2	
Reset point RP2 (hysteresis mode) Lower switch point FL2 (window mode)	25 % Measuring range	< SP2, FH2 Hysteresis \geq 1 % FS	RP2	
Switch point delay time SP1 / RP1 (hysteresis mode) Switch point delay time FH1 / FL1 (window mode)	0	0; 2 ^x [ms], x = 3, 4 ... 16	dS1	
Switch point delay time SP2 / RP2 (hysteresis mode) Switch point delay time FH2 / FL2 (window mode)	0	0; 2 ^x [ms], x = 3, 4 ... 16	dS2	
Functions switching output 1	Hysteresis, closer (Hno)	Hysteresis NO (Hno), Hysteresis NC (Hnc) Window NO (Fno), Window NC (Fnc)	ou1	
Functions switching output 2	Hysteresis, closer (Hno)	Hysteresis NO (Hno), Hysteresis NC (Hnc) Window NO (Fno), Window NC (Fnc) Device ready	ou2	

Parameterization of switching points

The switching points, delay times and output functions can be parameterized via Smartphone app (Android). The SMI Sensor Master Interface required for the parameterization as well as the Smartphone are not part of the delivery. The Android App is available for free in the Google Play Store.

- Ordering No. SMI Sensor Master Interface: F90170 (available from the 2nd quarter of 2018)
- Data sheet SMI Sensor Master Interface: H72618



Specifications		
Electrical Data	Output / supply voltage	4 ... 20 mA: 24 (9...32) VDC 0.5 ... 4.5 VDC: 24 (9...32) VDC 0 ... 5 VDC: 24 (9...32) VDC 1 ... 5 VDC: 24 (9...32) VDC 1 ... 6 VDC: 24 (9...32) VDC 0 ... 10 VDC: 24 (15...32) VDC 0.1 ... 10.1 VDC: 24 (15...32) VDC 0.5 ... 4.5 VDC ratiom., 10 ... 90% U_{supply} : 5 ± 0.25 VDC 1 or 2 PNP transistors: 24 (9...32) VDC
	Switch-on-delay pressure transmitters	100 ms
	Switch-on-delay pressure switches	50 ms + switching delay time
	Inverse-polarity protection, short-circuit strength @ 25°C during 5 min.	4...20 mA: to $U_s = 32$ VDC 0.5...4.5 VDC, 0...5 VDC, 1...5 VDC, 1...6 VDC, 0...10 VDC, 0.1...10.1 VDC: to $U_s = 28$ VDC 0.5...4.5 VDC ratiometric: to $U_s = 14$ VDC 1 or 2 PNP transistors: to $U_s = 32$ VDC
Environmental conditions	Media temperature	-40°C ... +125°C
	Ambient temperature	-40°C ... +125°C (Cable PVC 22: -5°C ... +60°C) (Cable PUR 24: -40°C ... +70°C)
	Protection ¹⁾	IP65, IP67
	Humidity	Max. 95 % relative
	Vibration	15 g RMS (20...2000 Hz) (EN60068-2-64) 25 g sin (80...2000 Hz), 1 oct./min, (1x @ 25°C) (EN60068-2-6)
	Shock	50 g / 11 ms 100 g / 6 ms Male electrical plug M12x1 (EN60068-2-27) ²⁾
EMC Protection	Emission	EN/IEC 61000-6-3
	Immunity	EN/IEC 61000-6-2
Mechanical Data	Sensor (wetted parts)	1.4542 (AISI630)
	Pressure connection (wetted parts)	1.4542 (AISI630)
	Housing	1.4301 (AISI304)
	Sealing	FPM/EPDM/NBR
	Male electrical plug	See ordering information
	Weight	appr. 50 g
	Mounting torque	25 Nm

¹⁾ See electrical connection

²⁾ For electrical connections 32 and 35

Analogue output

Accuracy	TEB @ -25 ... +85°C	[% FS typ.]	± 1.0
	Accuracy @ +25°C	[% FS typ.]	± 0.3
	NLH @ +25°C (BSL)	[% FS typ.]	± 0.2
	TC zero point and span	[% FS/K typ.]	± 0.01
	Long term stability 1 year	[% FS typ.]	± 0.1
Rise time	Typ. 1 ms / 10 ... 90 % nominal pressure		

Switching output

Accuracy	TEB @ -25 ... +85°C	[% FS typ.]	± 1.0
	Accuracy @ +25°C	[% FS typ.]	± 0.3
	Long term stability 1 year	[% FS typ.]	± 0.1
Adjustment range of switchpoints	1 ... 99 % FS		
Distance switch point	≥ 1.0 % FS		
Switch point > reset point	Switchpoint > reset point		
Switching resistance	≤ 3 Ω		
Output function	Hysteresis, Window; normally closed (NO), normally open (NC)		
Switching current	-40°C ... +85°C	(Ambient and media temperature)	≤ 400 mA, total of both switching outputs
	+85°C ... +125°C	(Ambient and media temperature)	≤ 200 mA, total of both switching outputs
Current limiting	integrated		
Delay time	0; 2*[ms], x = 3, 4 ... 16		
Switching frequency	max. 60 Hz (at switching delay time = 0)		

Measuring accuracy

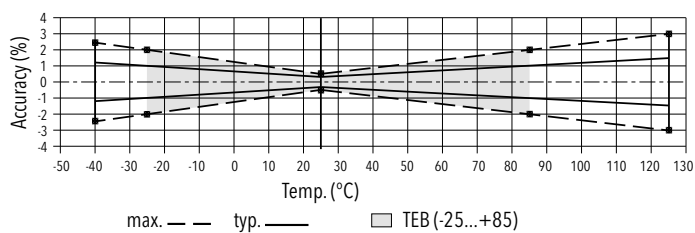

Dimensions

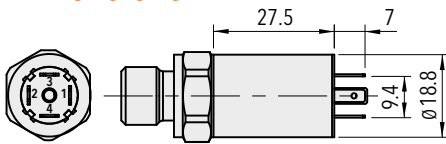

8254.XX.XXXX.01.XX.XX

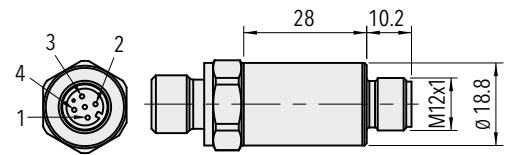

8254.XX.XXXX.32.XX.XX

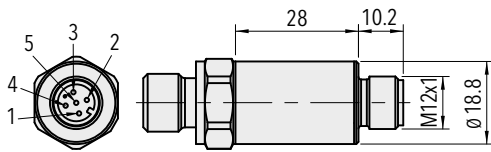

8254.XX.XXXX.35.XX.XX

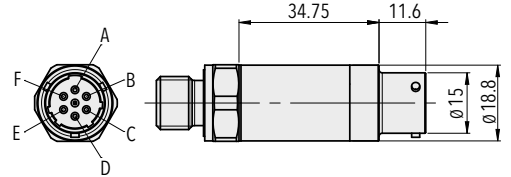

8254.XX.XXXX.02.XX.XX

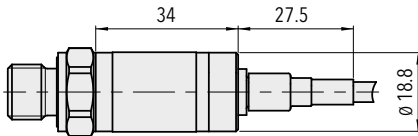

8254.XX.XXXX.22/24/08.XX.XX

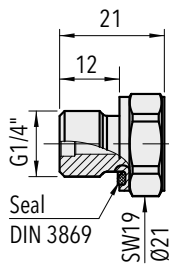

8254.XX.XX17.XX.XX.XX

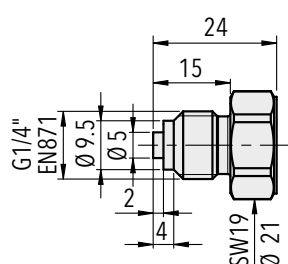

8254.XX.XX53.XX.XX.XX

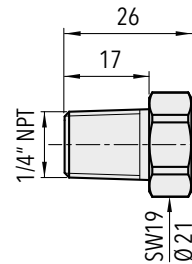

8254.XX.XX30.XX.XX.XX

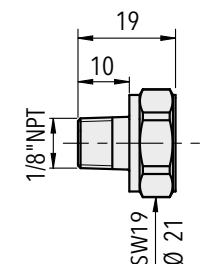

8254.XX.XX43.XX.XX.XX

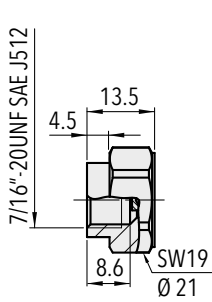

8254.XX.XX24.XX.XX.XX

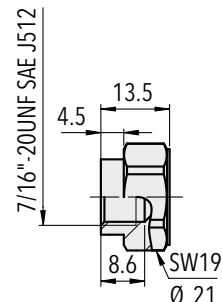

8254.XX.XX44.XX.XX.XX

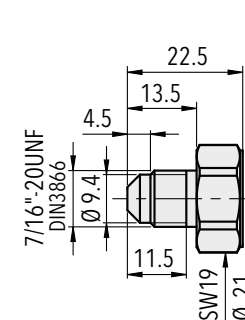

8254.XX.XX18.XX.XX.XX

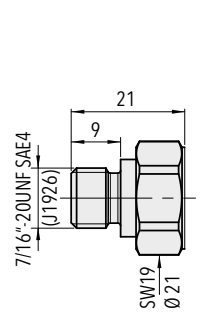

8254.XX.XX42.XX.XX.XX

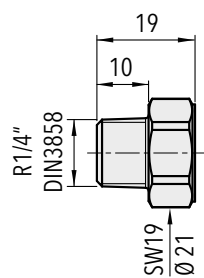

8254.XX.XX19.XX.XX.XX

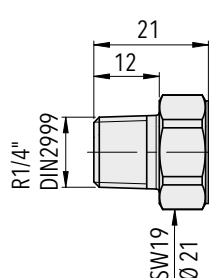

8254.XX.XX20.XX.XX.XX

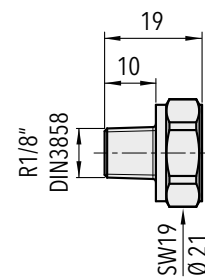

8254.XX.XX16.XX.XX.XX

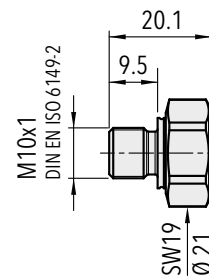

8254.XX.XX32.XX.XX.XX

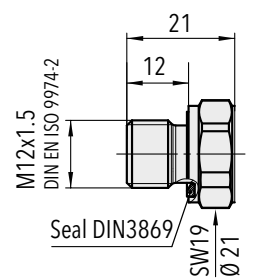

8254.XX.XX49.XX.XX.XX

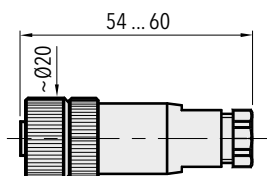

8254.XX.XXXX.XX.XX.33

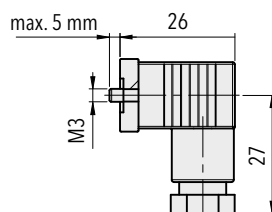

8254.XX.XXXX.XX.XX.34

Electrical connection

		Protection / electrical connection									
		IP65 *)**)		IP67 *)**)				IP67*)**)		IP67**)	
		Industrial standard Contact distance 9.4 mm		M12x1				MIL-C 26482		Cable	
		01		4-pole 32		5-pole 35		02		22/24	
Output signal	<p>8254.XX.XXXX.XX.19</p>	90	92	E1	E6						
		2	1	1	1	4	A	white	red		
		1	2	3	2	1	B	brown	black		
		4	3	4	4	5	E	yellow	green		
Output signal	<p>8254.XX.XXXXXX.13/14/16/17/20/23/25</p>	91	E3	95	96	E2					
		1	2	1	1	2		white	red		
		2	1	2	3	4		green	white		
		3	4	3	4	3		brown	black		
		4	3	4	2	4		yellow	green		

		Protection / electrical connection					
		IP67 *)**)		IP67**)		IP67**)	
		M12x1 4-pole		Cable		Cable	
		32		22/24		08	
Output signal	<p>8254.XX.XXXX.XX.PS/T1</p>	PS	T1	PS	T1	PS	T1
		1	1	white	white	red	red
		4	4	green	green	white	white
		2	-	yellow	-	green	-
		3	3	brown	brown	black	black

*) Nur mit vorschriftsmässig montierter Kabeldose gültig

**) Entlüftung über Stecker/Kabel

4...20mA: min./max resistor vs. supply voltage @ Pmax = 100%

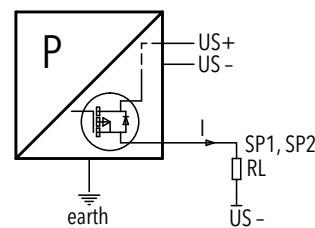
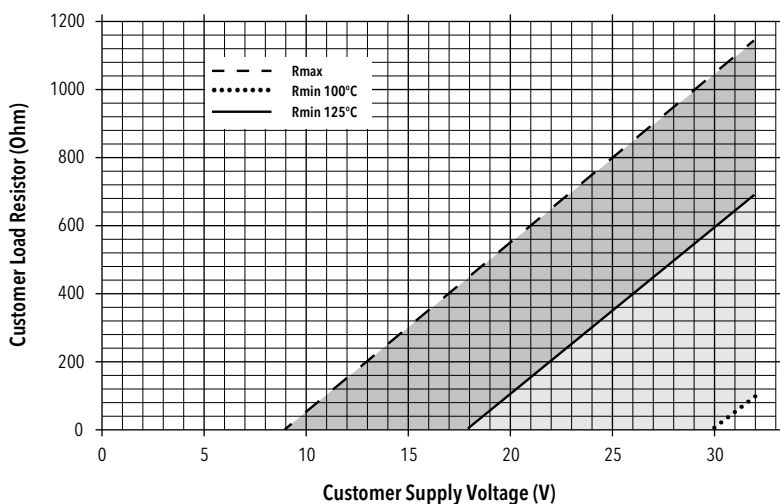

Connection of loads to switch contacts

Functions switching output

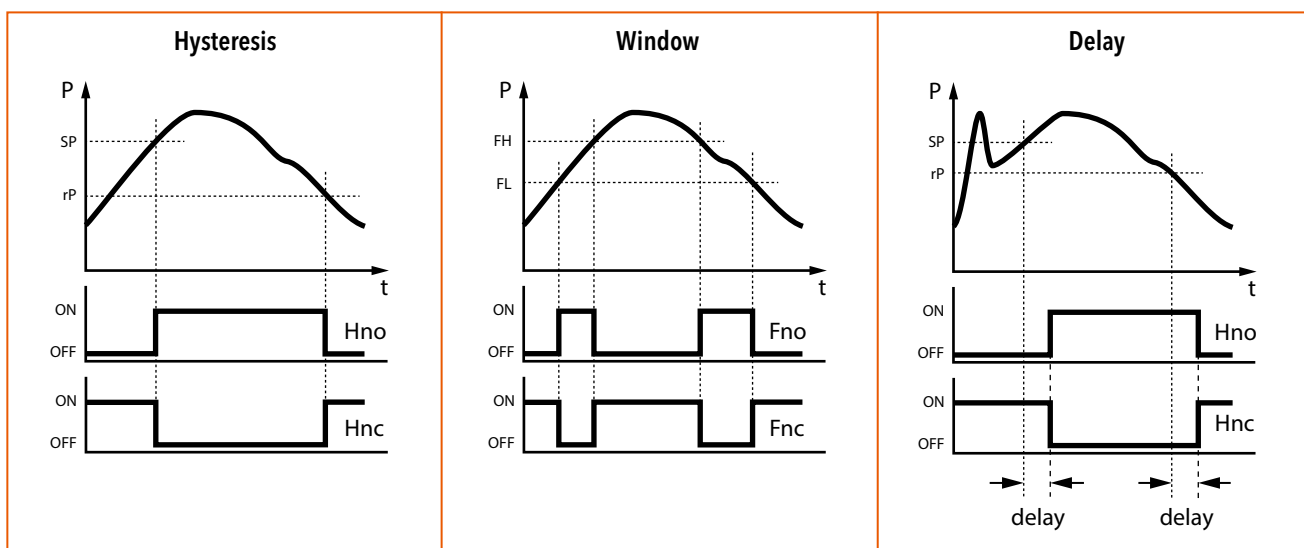

Additional information

Documents

Data sheet	www.trafag.com/H72304
Instructions	www.trafag.com/H73303
Flyer	www.trafag.com/H70682

ENGINE PRESSURE TRANSMITTER

Swiss based Trafag is a leading international supplier of high quality sensors and monitoring instruments for measurement of pressure and temperature. The engine and shipbuilding pressure transmitter NAE 8256 features the extremely robust and stable thin-film-on-steel sensor element. The NAE 8256 is the smallest pressure transmitter of its kind with ship approvals. The wide temperature range from -40°C up to +125°C and triple overpressure safety makes it the first choice in rough environments such as marine applications.



Applications

- Shipbuilding
- Engine manufacturing
- Hydraulics

Features

- Measuring accuracy 0.3 %, 0.5 %
- Completely welded steel sensor system without additional seals
- Smallest design
- High resistance to over pressure
- Excellent long-term stability

Technical Data			
Measuring principle	Thin film on steel	Media temperature	-40°C ... +125°C
Measuring range	0 ... 6 to 0 ... 600 bar 0 ... 100 to 0 ... 7500 psi	Ambient temperature	-40°C ... +125°C
Output signal	4 ... 20 mA	Approval / conformity	ABS, BV, DNV-GL, KRS, LRS, NKK, RINA, RMRS
Accuracy @ 25°C typ.	0.5 %: ± 0.5 % FS typ. 0.3 %: ± 0.3 % FS typ.		

Subject to change

Ordering information/type code

							8256 . XX	XX	XX	XX	XX	XX	
Measuring range ¹⁾	Pressure measurement range [bar]	Over pressure [bar]	Burst pressure [bar]		Pressure measurement range [psi]	Over pressure [psi]	Burst pressure [psi]						
	0 ... 6 ^{5) 6)}	18	100	77	0 ... 100 ^{5) 6)}	300	1450	G7					
	0 ... 10	30	200	78	0 ... 150	450	2500	G8					
	0 ... 16	48	200	79	0 ... 200	600	2500	GA					
	0 ... 25	75	300	80	0 ... 250	750	2500	G9					
	0 ... 40	120	300	81	0 ... 300	900	4000	HA					
	0 ... 60	180	400	82	0 ... 400	1200	4000	H0					
	0 ... 100	300	500	83	0 ... 500	1200	4000	H1					
	0 ... 160	480	750	85	0 ... 1000	3000	5000	H2					
	0 ... 250	750	1000	74	0 ... 1500	4500	7000	H3					
	0 ... 400	1000	2000	84	0 ... 2000	6000	10000	H5					
	0 ... 600	1500	2500	86	0 ... 3000	9000	14500	G4					
					0 ... 5000	12500	21750	H4					
					0 ... 7500	18750	29000	H6					
Sensor	Relative pressure, accuracy: 0.5 %											25	
	Relative pressure, accuracy: 0.3 %												23
Pressure connection	G1/4" male, seal: DIN 3869 (accessories 61/63/83)											17	
	G1/4" male (Manometer) EN 871 ⁶⁾												53
	1/4" NPT male												30
	M10x1 male												32
Electrical connection	Male electrical plug, industrial standard, contact distance 9.4 mm, Mat. PA											01	
	Male electrical plug M12x1, 4-pole, Mat. PA											32	
	Male electrical plug M12x1, 5-pole, Mat. PA											35	
Output signal	Signal output	Load resistance	I (supply)		U (supply)								
	4 ... 20 mA 	See graphic			24 (9 ... 32) VDC							19	
Accessories	Female electrical plug M12x1, 5-pole ²⁾											33	
	Female electrical connector industrial standard ³⁾												34
	Pressure peak damping element ø 0.4 mm												44
	Seal FPM, -18°C ... +125°C ⁴⁾												61
	Seal EPDM, -40°C ... +125°C ⁴⁾												63
	Seal NBR, -25°C ... +100°C ⁴⁾												83
	Special electrical connection: Pin 2 +, Pin 3 ground, Pin 4 - (only for male electrical plug 01, industrial standard)												90
	Special electrical connection: Pin 1 +, Pin 2 -, Pin 4 ground (only for output signal 19 and male electrical plug 32, M12x1, 4-pole)												E1

¹⁾ Customized pressure ranges upon request

²⁾ For electrical connections 32 and 35

³⁾ For electrical connection 01

⁴⁾ Only with pressure connection 17 (G1/4")

⁵⁾ Only with sensor 23 (accuracy 0.3 %)

⁶⁾ Only with ship approval DNV-GL

Standard products (extra short lead time)

Product No.	Type Code	Pressure range [bar]	Over pressure max. [bar]	Supply [VDC]	Accuracy @ 25°C typ. [%]
NAE10.0A	8256 78 2317 32 0000 0000 19 33 44 61	0 ... 10	30	9 ... 32	± 0.3
NAE16.0A	8256 79 2317 32 0000 0000 19 33 44 61	0 ... 16	48	9 ... 32	± 0.3
NAE25.0A	8256 80 2317 32 0000 0000 19 33 44 61	0 ... 25	75	9 ... 32	± 0.3
NAE40.0A	8256 81 2317 32 0000 0000 19 33 44 61	0 ... 40	120	9 ... 32	± 0.3
NAE100.0A	8256 83 2317 32 0000 0000 19 33 44 61	0 ... 100	300	9 ... 32	± 0.3
NAE250.0A	8256 74 2317 32 0000 0000 19 33 44 61	0 ... 250	750	9 ... 32	± 0.3
NAE400.0A	8256 84 2317 32 0000 0000 19 33 44 61	0 ... 400	1000	9 ... 32	± 0.3
NAE600.0A	8256 86 2317 32 0000 0000 19 33 44 61	0 ... 600	1500	9 ... 32	± 0.3

Specifications		
Accuracy	TEB typ. @ -25 ... +85°C	0.5 %: ± 1.75 % FS typ. 0.3 %: ± 1.0 % FS typ.
	Accuracy @ 25°C typ.	0.5 %: ± 0.5 % FS typ. 0.3 %: ± 0.3 % FS typ.
	NLH @ 25°C (BSL) typ.	0.5 %: ± 0.2 % FS typ. 0.3 %: ± 0.2 % FS typ.
	TC zero point and span typ.	0.5 %: ± 0.03 % FS/K typ. 0.3 %: ± 0.01 % FS/K typ.
	Long term stability 1 year typ.	± 0.1 % FS typ.
Electrical Data	Output / supply voltage	4 ... 20 mA: 24 (9...32)VDC
	Rise time	Typ. 1 ms / 10 ... 90 % nominal pressure
	Switch-on-delay	100 ms
	Inverse-polarity protection, short-circuit strength @ 25°C during 5 min.	4 ... 20 mA: to $U_{supply} = 32 V$
Environmental conditions	Media temperature	-40°C ... +125°C
	Ambient temperature	-40°C ... +125°C
	Protection ¹⁾	IP65, IP67
	Humidity	Max. 95% relative
	Vibration	15 g RMS (20...2000 Hz) 25 g sin (80...2000 Hz), 1 oct./min, (1x @ 25°C)
	Shock	50 g / 11 ms
EMC Protection	Emission	EN/IEC 61000-6-3
	Immunity	EN/IEC 61000-6-2
Mechanical Data	Sensor (wetted parts)	1.4542 (AISI630)
	Pressure connection (wetted parts)	1.4542 (AISI630)
	Housing	1.4301 (AISI304)
	Sealing	FPM/NBR/EPDM
	Male electrical plug	See ordering information
	Weight	~ 50 g
	Mounting torque	25 Nm

¹⁾ See electrical connection

Measuring accuracy 0.5 %

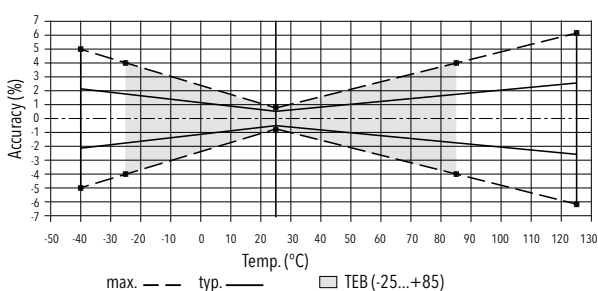

Measuring accuracy 0.3 %

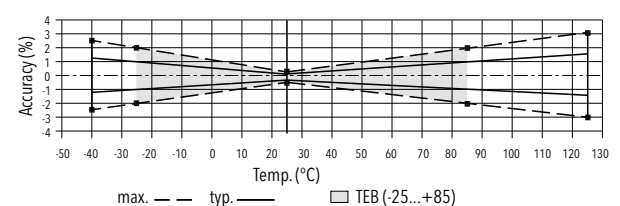

Dimensions

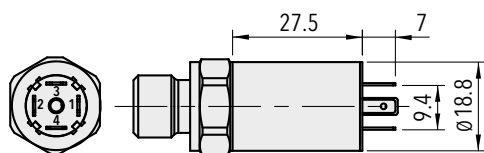

8256.XX.XXXX.01.XX.XX

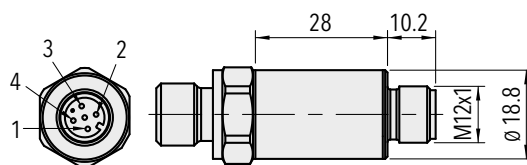

8256.XX.XXXX.32.XX.XX

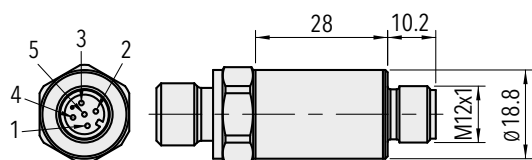

8256.XX.XXXX.35.XX.XX

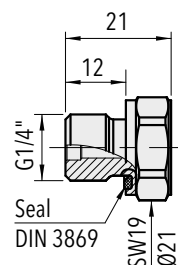

8256.XX.XX17.XX.XX.XX

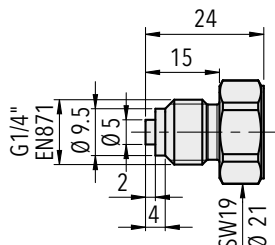

8256.XX.XX53.XX.XX.XX

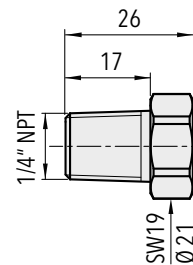

8256.XX.XX30.XX.XX.XX

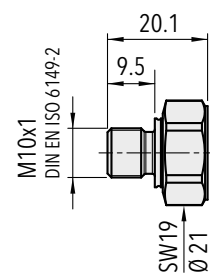

8256.XX.XX32.XX.XX.XX

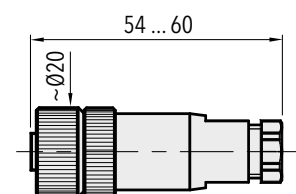

8256.XX.XXXX.XX.XX.33

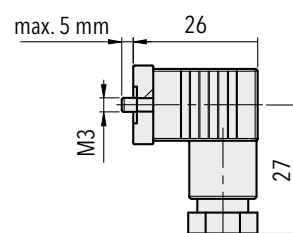

8256.XX.XXXX.XX.XX.34

Electrical connection

		Protection / electrical connection				
		IP65*)		IP67*)		
		Industrial standard Contact distance 9.4 mm 01	M12x1			
			4-pole 32	5-pole 35		
Output signal						
	8256.XX.XXXX.XX.19					
		90	E1			
		2	2	1	1	4
	1	4	3	2	1	
	4	3	4	4	5	

*) Provided female connector is mounted according to instructions

4...20mA: min./max resistor vs. supply voltage @ Pmax = 100%

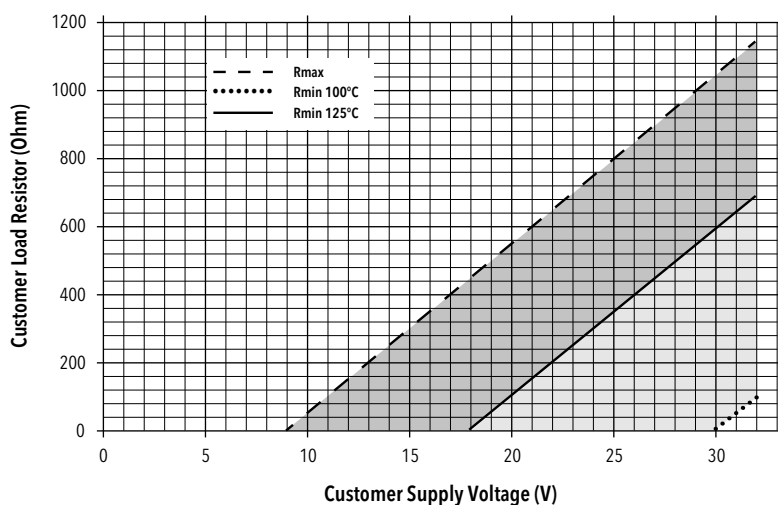

Additional information

Documents

Data sheet	www.trafag.com/H72305
Instructions	www.trafag.com/H73303
Flyer	www.trafag.com/H70684

LOW PRESSURE TRANSMITTER

Swiss based Trafag is a leading international supplier of high quality sensors and monitoring instruments for measurement of pressure and temperature. The very compact NSL low pressure transmitter is the only pressure transmitter in the market with thin-film-on-steel-membrane and pressure ranges down to 0 .. 200 mbar. This combination allows also for low pressure ranges accurate measurements with excellent longterm stability. Through the extraordinary high burst pressures up to 125 times nominal pressure the NSL is the first choice for critical applications.



Applications

- Shipbuilding
- Engine manufacturing
- Machine tools
- Process technology
- Water treatment
- Test benches



Features

- Smallest design
- Relative or absolute pressure measurement
- Excellent temperature resistance
- Improved vibration resistance
- Completely welded steel sensor system without additional seals

Technical Data			
Measuring principle	Thin film on steel	Media temperature	-40°C ... +125°C
Measuring range	0 ... 0.2 to 0 ... 2.5 bar 0 ... 3 to 0 ... 30 psi	Ambient temperature	-40°C ... +125°C
Output signal	4 ... 20 mA, 0 ... 5 VDC, 0 ... 10 VDC, 0.5 ... 4.5 VDC ratiometric	Approval / conformity	DNV-GL, RINA
Accuracy @ 25°C typ.	0.15 ... 0.8 % FS typ.		

Subject to change

Ordering information/type code

8257 . XX . XX . XX . XX . XX . XX

Measuring range ¹⁾	Pressure measurement range [bar]	Over pressure [bar]	Burst pressure [bar]		Pressure measurement range [psi]	Over pressure [psi]	Burst pressure [psi]		
	0 ... 0.2 ²⁾	1.2	25	68		0 ... 3 ³⁾	18	350	F8
0 ... 0.4	1.2	25	69		0 ... 5 ³⁾	18	350	F9	
0 ... 0.6	1.5	25	70		0 ... 10 ³⁾	25	350	G0	
0 ... 1.0	2.0	25	71		0 ... 15 ³⁾	30	350	G1	
0 ... 1.6	3.5	80	73		0 ... 25 ³⁾	50	1200	G3	
0 ... 2.5	5.0	80	75		0 ... 30 ³⁾	70	1200	G5	
Sensor	Relative pressure, accuracy: 0.3%								23
	Absolute pressure, accuracy: 0.3%								43
	Relative pressure, accuracy: 0.15% ⁴⁾								21
	Absolute pressure, accuracy: 0.15% ⁴⁾								41
Pressure connection	G1/4" male (O-Ring)								17
	1/4"NPT male								30
Electrical connection	Male electrical plug, Industrial standard (contact distance 9.4mm), Mat. PBT								01
	Male electrical plug M12x1, 4-pole, Mat. PBT								32
	Male electrical plug M12x1, 5-pole, Mat. PBT								35
Output	Output	Load resistance	I (supply)		U (supply)				
	4 ... 20mA	(U _{supply} -9V) / 20mA			24 (9 ... 32)VDC			19	
	0 ... 5 VDC ⁵⁾	≥ 2.0 kΩ	≤ 10 mA		24 (9 ... 32)VDC			14	
	0 ... 10 VDC ⁵⁾	≥ 5.0 kΩ	≤ 10 mA		24 (15 ... 32)VDC			17	
	0.5 ... 4.5 VDC ⁵⁾	≥ 2.0 kΩ	≤ 10 mA		5 (4.5 ... 5.5)VDC ratiom.			23	
Accessories	Female electrical plug M12x1, 5-pole, for executions 32 and 35								33
	Female electrical plug industrial standard								34
	Pressure peak damping element ø 1.0 mm								40
	Pressure peak damping element ø 0.3 mm								43
	Pressure peak damping element ø 0.5 mm								45

¹⁾ Extended overpressure as well as customized pressure ranges upon request

²⁾ Relative pressure only

³⁾ No ship approval DNV

⁴⁾ Only for pressure ranges from 0.6 bar / 10 psi

⁵⁾ No ship approval



Identical construction with higher pressure ranges: Data sheet No. H72250, H72300

Standard products (extra short lead time)

Product No.	Type Code	Pressure range [bar]	Over pressure max. [bar]	Supply [VDC]	Accuracy @ 25°C typ. [%]
NSL0.2A	8257 68 2317 32 0000 0000 19 33 43	0 ... 0.2	1.2	9 ... 32	± 0.8
NSL0.4A	8257 69 2317 32 0000 0000 19 33 43	0 ... 0.4	1.2	9 ... 32	± 0.5
NSL0.6A	8257 70 2317 32 0000 0000 19 33 43	0 ... 0.6	1.5	9 ... 32	± 0.3
NSL1.0A	8257 71 2317 32 0000 0000 19 33 43	0 ... 1.0	2	9 ... 32	± 0.3
NSL1.6A	8257 73 2317 32 0000 0000 19 33 43	0 ... 1.6	3.5	9 ... 32	± 0.3
NSL2.5A	8257 75 2317 32 0000 0000 19 33 43	0 ... 2.5	5	9 ... 32	± 0.3

Specifications		
Electrical Data	Output / supply voltage	4...20 mA: 24 (9...32) VDC 0...5 VDC: 24 (9...32) VDC 0...10 VDC: 24 (15...32) VDC 0.5...4.5 VDC: 5 VDC ratiom.
	Rise time	Typ. 1 ms/10...90 % nominal pressure
	Switch-on-delay	1 s
Environmental conditions	Media temperature	-40°C ... +125°C
	Ambient temperature	-40°C ... +125°C
	Protection ¹⁾	Min. IP65
	Humidity	Max. 95 % relative
	Vibration	25g (20...2000 Hz)
	Shock	100 g/11ms
EMC Protection	Emission	EN/IEC 61000-6-4
	Immunity	EN/IEC 61000-6-2
Mechanical Data	Sensor (wetted parts)	1.4542 (AISI630)
	Pressure connection (wetted parts)	1.4542 (AISI630)
	Housing	1.4301 (AISI304)
	Sealing	FKM 70 Sh
	Male electrical plug	See ordering information
	Weight	~ 50 g
	Mounting torque	25 Nm (see "Accuracy")

¹⁾ See electrical connection

Accuracy									
		Sensor 23/43 (0.3%)					Sensor 21/41 (0.15%)		
Range	[bar]	0 ... 0.2	0 ... 0.4	0 ... 0.6	0 ... 1.0	0 ... 1.6	0...0.6	0...1.6	
	[psi]	0 ... 3	0 ... 5	0 ... 10	0 ... 15	0 ... 25 0 ... 30	0...1.0 0...15	0...2.5 0...30	
NLH @ +25°C (+77°F) BSL	[% FS typ.]	0.2	0.2	0.2	0.2	0.2	0.2	0.2	0.2
TEB @ -25...+85°C (-13...+185°F)	[% FS typ.]	2	1.5	1	1	1	0.5	0.5	
Accuracy@ +25°C (+77°F)	[% FS typ.]	0.8	0.5	0.3	0.3	0.3	0.15	0.15	
Long term stability 1 year @ +25°C (+77°F)	[% FS typ.]	0.3	0.15	0.1	0.1	0.1	0.1	0.1	
TC zero point and span	[% FS/K typ.]	0.02	0.015	0.01	0.01	0.01	0.002	0.002	
Mounting dependency with 180° rotation (Vibration and shock: multiply this value with number of g)	[% FS typ.]	0.25	0.13	0.09	0.05	< 0.05	0.05	< 0.05	
Error mounting torque @ 25Nm	[% FS typ.]	0.25	0.13	0.09	0.05	0.05	0.05	0.05	

Dimensions

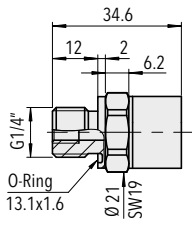

8257.XX.2317.XX.XX.XX
8257.XX.2117.XX.XX.XX

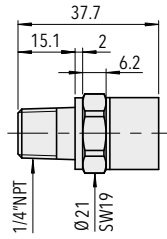

8257.XX.2330.XX.XX.XX
8257.XX.2130.XX.XX.XX

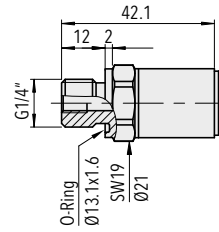

8257.XX.4317.XX.XX.XX
8257.XX.4117.XX.XX.XX

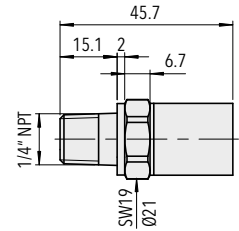

8257.XX.4330.XX.XX.XX
8257.XX.4130.XX.XX.XX

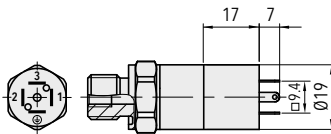

8257.XX.XXXX.01.XX.XX

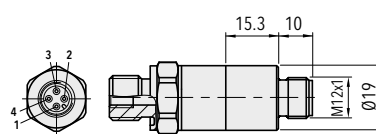

8257.XX.XXXX.32.XX.XX

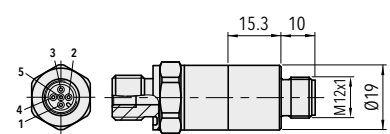

8257.XX.XXXX.35.XX.XX

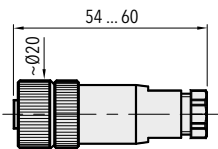

8257.XX.XXXX.XX.XX.33

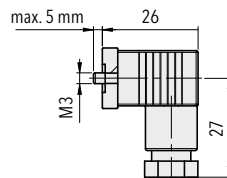

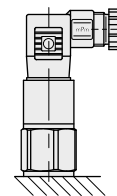

8257.XX.XXXX.XX.XX.34

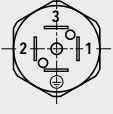

Recommended mounting position
(Mounting dependency with 180° rotation see 'Accuracy')

Electrical Connection

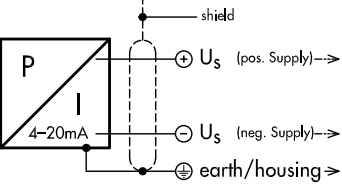
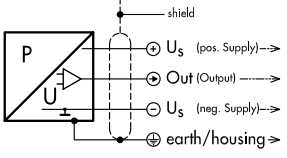
		Protection / electrical connection		
		IP65*)	IP67*)	
		Industrial standard EN175301-803A 01 	4-pole 32 	5-pole 35 
Output signal	 <p>8257.XX.XXXX.XX.19</p>	<p>2</p> <p>1</p> <p>⊕</p>	<p>1</p> <p>3</p> <p>4</p>	<p>4</p> <p>1</p> <p>5</p>
	 <p>8257.XX.XXXX.XX.14/17/23</p>	<p>1</p> <p>2</p> <p>3</p> <p>⊕</p>	<p>1</p> <p>2</p> <p>3</p> <p>4</p>	<p>2</p> <p>4</p> <p>3</p> <p>5</p>

*) Provided female connector is mounted according to instructions

Additional information

Documents		
	Data sheet	www.trafag.com/H72302
	Instructions	www.trafag.com/H73250
	Flyer	www.trafag.com/H70671

RAILWAY PRESSURE TRANSMITTER

Swiss based Trafag is a leading international supplier of high quality sensors and monitoring instruments for measurement of pressure and temperature. The pressure transmitter NAR 8258 with increased accuracy of 0.3 % was specifically designed for railway vehicles (EN 50155) and has a long-term stable thin-film-on-steel sensor cell. The wide temperature range from -40°C to +125°C and the triple overpressure protection make the NAR 8258 the ideal choice for railway vehicles in rough environmental conditions.



Applications

- Railways

Features

- Measuring accuracy 0.3 %
- Optional: Switching output 1 or 2 PNP transistors
- Excellent long-term stability
- Dielectrical strength: 710 VDC, meets EN 50155 (Railways)

Technical Data			
Measuring principle	Thin film on steel	Media temperature	-40°C ... +125°C
Measuring range	0 ... 6 to 0 ... 600 bar 0 ... 100 to 0 ... 7500 psi	Ambient temperature	-40°C ... +125°C
Output signal	4 ... 20 mA, Switching output: 1 or 2 PNP transistors	Approval / conformity	EN 50155 (Railway) EN 45545-2 (Fire protection) EN 61373 (Shock, vibration) EN 50121-3-2 (EMC)
Accuracy @ 25°C typ.	± 0.3 % FS typ.		

Subject to change

Ordering information/type code

				8258 . XX			XX	XX	XX	XX	XX
Measuring range ¹⁾	Pressure measurement range [bar]	Over pressure [bar]	Burst pressure [bar]		Pressure measurement range [psi]	Over pressure [psi]	Burst pressure [psi]				
	0 ... 6	18	100	77	0 ... 100	300	1450	G7			
	0 ... 10	30	200	78	0 ... 150	450	2500	G8			
	0 ... 16	48	200	79	0 ... 200	600	2500	GA			
	0 ... 25 ⁸⁾	75	300	80	0 ... 250	750	2500	G9			
	0 ... 40 ⁸⁾	120	300	81	0 ... 300 ⁸⁾	900	4000	HA			
	0 ... 60 ⁸⁾	180	400	82	0 ... 400 ⁸⁾	1200	4000	H0			
	0 ... 100 ⁸⁾	300	500	83	0 ... 1000 ⁸⁾	3000	5000	H2			
	0 ... 160 ⁸⁾	480	750	85	0 ... 1500 ⁸⁾	4500	7000	H3			
	0 ... 250	750	1000	74	0 ... 2000 ⁸⁾	6000	10000	H5			
	0 ... 400	1000	2000	84	0 ... 3000	9000	14500	G4			
	0 ... 600	1500	2500	86	0 ... 5000	12500	21750	H4			
					0 ... 7500	18750	29000	H6			
	Sensor	Relative pressure, accuracy: 0.3 %							23		
Pressure connection	G1/4" male, seal: DIN 3869 (accessory 61/63/83)	17	7/16"-20UNF SAE4 male, seal: accessory 61 ⁷⁾		42						
	G1/4" male (Manometer) EN 871 ⁸⁾	53	M10x1 male, DIN EN ISO 6149-2		32						
	1/4" NPT male	30	M12x1.5 male, DIN EN ISO 9974-2 ⁸⁾		49						
Electrical connection	Male electrical plug, industrial standard, contact distance 9.4 mm, Mat. PA							01			
	Male electrical plug M12x1, 4-pole, Mat. PA							32			
	Male electrical plug M12x1, 5-pole, Mat. PA							35			
Output signal	Signal output	Load resistance	I (supply)		U (supply)						
	4 ... 20mA	See graphic			24 (9 ... 32) VDC		19				
	2 PNP transistors ³⁾		≤ 10 mA		24 (9 ... 32) VDC		PS				
	1 PNP transistor ³⁾		≤ 10 mA		24 (9 ... 32) VDC		T1				
Accessories	Female electrical plug M12x1, 5-pole ²⁾							33			
	Female electrical connector industrial standard (for electrical connection 01)							34			
	Pressure peak damping element ø 1.0 mm ⁶⁾							40			
	Pressure peak damping element ø 0.4 mm ⁶⁾							44			
	Seal FPM, -18°C ... +125°C							61			
	Seal EPDM, -40°C ... +125°C							63			
	Seal NBR, -25°C ... +100°C							83			
	Special electrical connection: Pin 2 +, Pin 3 ground, Pin 4 - (only for output signal 19 and male electrical plug 01, industrial standard)							90			
	Special electrical connection: Pin 1 +, Pin 2 -, Pin 4 ground (only for output signal 19 and male electrical plug 01, industrial standard)							92			
	Special electrical connection: Pin 1 +, Pin 2 -, Pin 4 ground (only for output signal 19 and male electrical plug 32, M12x1, 4-pole)							E1			
	Parameterisation according to customer specification (see table parameter), for output signal PS, T1							ZC			

¹⁾ Customized pressure ranges upon request

²⁾ For electrical connections 32 and 35

³⁾ Only with electrical connection 32

⁴⁾ Max. allowable pressure range 60 bar at 120 bar overpressure

⁵⁾ Max. allowable pressure range 160 bar at 500 bar overpressure

⁶⁾ Only for pressure connections 17, 30, 32

⁷⁾ According to norm J1926, max. 35 MPa

⁸⁾ Upon request

Parameter				
Name	Standard setting (accessory ZS)	Value range	Short name	Customer adjustment (accessory ZC)
Switch point SP1 (hysteresis mode) Upper switch point FH1 (window mode)	75 % Measuring range	> RP1, FL1 Hysteresis \geq 1 % FS	SP1	
Reset point RP1 (hysteresis mode) Lower switch point FL1 (window mode)	25 % Measuring range	< SP1, FH1 Hysteresis \geq 1 % FS	RP1	
Switch point SP2 (hysteresis mode) Upper switch point FH2 (window mode)	75 % Measuring range	> RP2, FL2 Hysteresis \geq 1 % FS	SP2	
Reset point RP2 (hysteresis mode) Lower switch point FL2 (window mode)	25 % Measuring range	< SP2, FH2 Hysteresis \geq 1 % FS	RP2	
Switch point delay time SP1 / RP1 (hysteresis mode) Switch point delay time FH1 / FL1 (window mode)	0	0; 2 ^x [ms], x = 3, 4 ... 16	dS1	
Switch point delay time SP2 / RP2 (hysteresis mode) Switch point delay time FH2 / FL2 (window mode)	0	0; 2 ^x [ms], x = 3, 4 ... 16	dS2	
Functions switching output 1	Hysteresis, closer (Hno)	Hysteresis NO (Hno), Hysteresis NC (Hnc) Window NO (Fno), Window NC (Fnc)	ou1	
Functions switching output 2	Hysteresis, closer (Hno)	Hysteresis NO (Hno), Hysteresis NC (Hnc) Window NO (Fno), Window NC (Fnc) Device ready	ou2	

Parameterization of switching points

The switching points, delay times and output functions can be parameterized via Smartphone app (Android). The SMI Sensor Master Interface required for the parameterization as well as the Smartphone are not part of the delivery. The Android App is available for free in the Google Play Store.

- Ordering No. SMI Sensor Master Interface: F90170 (available from the 2nd quarter of 2018)
- Data sheet SMI Sensor Master Interface: H72618



Specifications		
Electrical Data	Output / supply voltage	4 ... 20 mA: 24 (9...32) VDC 1 or 2 PNP transistors: 24 (9...32) VDC
	Switch-on-delay pressure transmitters	100 ms
	Switch-on-delay pressure switches	50 ms + switching delay time
	Inverse-polarity protection, short-circuit strength @ 25°C during 5 min.	4...20 mA: to $U_s = 32$ VDC 1 or 2 PNP transistors: to $U_s = 32$ VDC
Environmental conditions	Media temperature	-40°C ... +125°C
	Ambient temperature	-40°C ... +125°C
	Protection ¹⁾	IP65, IP67
	Humidity	Max. 95 % relative
	Vibration	15 g RMS (20...2000 Hz) (EN60068-2-64) 25 g sin (80...2000 Hz), 1 oct./min, (1x @ 25°C) (EN60068-2-6)
	Shock	50 g / 11 ms 100 g / 6 ms Male electrical plug M12x1 (EN60068-2-27) ³⁾
EMC Protection	Emission	EN/IEC 61000-6-3 EN50121-3-2
	Immunity	EN/IEC 61000-6-2 EN50121-3-2 ²⁾
Mechanical Data	Sensor (wetted parts)	1.4542 (AISI630)
	Pressure connection (wetted parts)	1.4542 (AISI630)
	Housing	1.4301 (AISI304)
	Sealing	FPM/EPDM/NBR
	Male electrical plug	See ordering information
	Weight	appr. 50 g
	Mounting torque	25 Nm

¹⁾ See electrical connection

²⁾ Surge voltage on shield, shield connected on both sides

³⁾ For electrical connections 32 and 35

Analogue output

Accuracy	TEB @ -25 ... +85°C	[% FS typ.]	± 1.0
	Accuracy @ +25°C	[% FS typ.]	± 0.3
	NLH @ +25°C (BSL)	[% FS typ.]	± 0.2
	TC zero point and span	[% FS/K typ.]	± 0.01
Rise time	Long term stability 1 year	[% FS typ.]	± 0.1
	Typ. 1 ms / 10 ... 90 % nominal pressure		

Switching output

Accuracy	TEB @ -25 ... +85°C	[% FS typ.]	± 1.0
	Accuracy @ +25°C	[% FS typ.]	± 0.3
	Long term stability 1 year	[% FS typ.]	± 0.1
Adjustment range of switchpoints	1 ... 99 % FS		
Distance switch point	≥ 1.0 % FS		
Switch point > reset point	Switchpoint > reset point		
Switching resistance	≤ 3 Ω		
Output function	Hysteresis, Window; normally closed (NO), normally open (NC)		
Switching current	-40°C ... +85°C	(Ambient and media temperature)	≤ 400 mA, total of both switching outputs
	+85°C ... +125°C	(Ambient and media temperature)	≤ 200 mA, total of both switching outputs
Current limiting	integrated		
Delay time	0; 2*[ms], x = 3, 4 ... 16		
Switching frequency	max. 60 Hz (at switching delay time = 0)		

Measuring accuracy

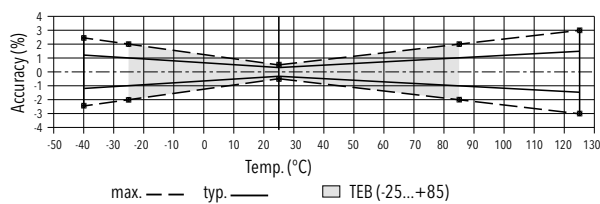

Additional specifications railways			
Environmental conditions	Cold	EN 60068-2-1	Ab: -40°C, 2 h (not in operation) Ae: -40°C, 1 h (in operation)
	Dry heat	EN 60068-2-2	Be: 85°C, 6 h (in operation)
	Damp heat, cyclical	EN 60068-2-30	Db: 55°C, variant 1, 2 cycles (2 x 24 h)
	Ambient temperature	EN 50155	Class TX
	Vibration and shock	EN 61373	Vibration: category 3 Shock: category 3 ¹⁾
	Dielectrical strength	EN 50155	710 VDC
	Resistance of insulation	EN 50155	>100 MΩ, 500 VDC
	Behavior in case of fire (electrical connections 01, 32, 35)	EN 45545-2	Weight: < 10 g Surface: < 0.2 m ²
Supply	Nominal voltage	EN 50155 ²⁾	24 V
	Interruptions of the voltage supply	EN 50155 ²⁾	Class S1
	Switching between two supply voltages	EN 50155 ²⁾	Class C1

¹⁾ In Category 3 the 2010 versions' higher severity levels apply in each case

²⁾ Chapter 5.1 Voltage supply

Dimensions

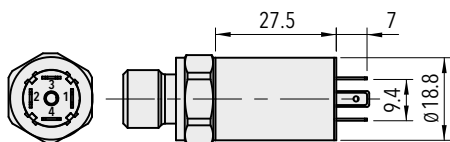

8258.XX.XXXX.01.XX.XX

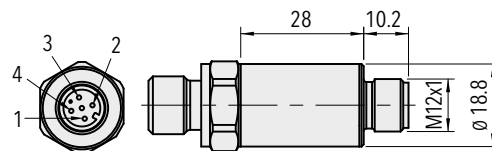

8258.XX.XXXX.32.XX.XX

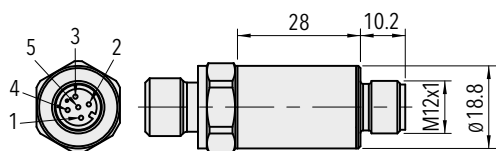

8258.XX.XXXX.35.XX.XX

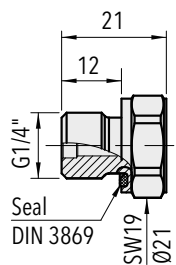

8258.XX.XX17.XX.XX.XX

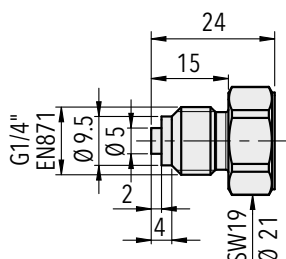

8258.XX.XX53.XX.XX.XX

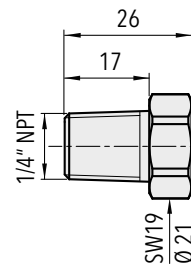

8258.XX.XX30.XX.XX.XX

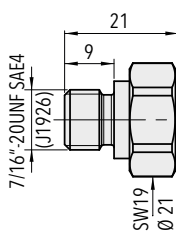

8258.XX.XX42.XX.XX.XX

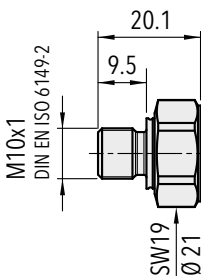

8258.XX.XX32.XX.XX.XX

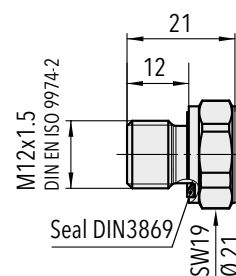

8258.XX.XX49.XX.XX.XX

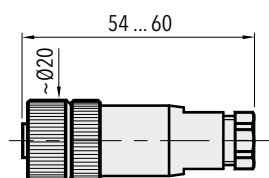

8258.XX.XXXX.XX.XX.33

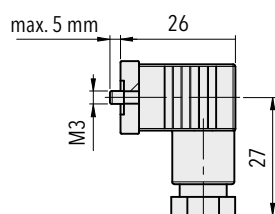

8258.XX.XXXX.XX.XX.34

Electrical connection

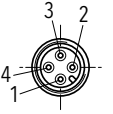
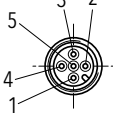
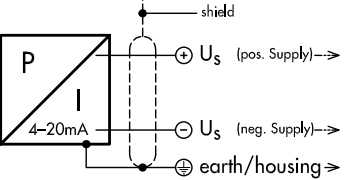
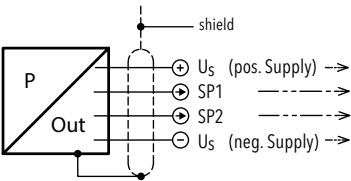
		Protection / electrical connection					
		IP65 *)**)			IP67 *)**)		
		Industrial standard Contact distance 9.4 mm		M12x1 4-pole		5-pole	
		01		32		35	
							
Output signal	 <p>8258.XX.XXXX.XX.19</p>		90	92		E1	
	 <p>8258.XX.XXXX.XX.PS/T1</p>				PS	T1	
		2	2	1	1	1	4
		1	4	2	3	2	1
		4	3	4	4	4	5
					1	1	
					4	4	
					2	-	
					3	3	

*) Provided female connector is mounted according to instructions

**) Ventilation via male electric plug/cable end

4...20mA: min./max resistor vs. supply voltage @ Pmax = 100%

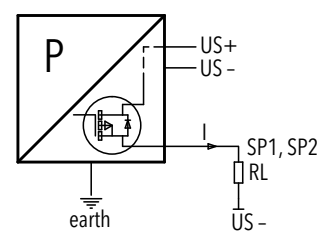
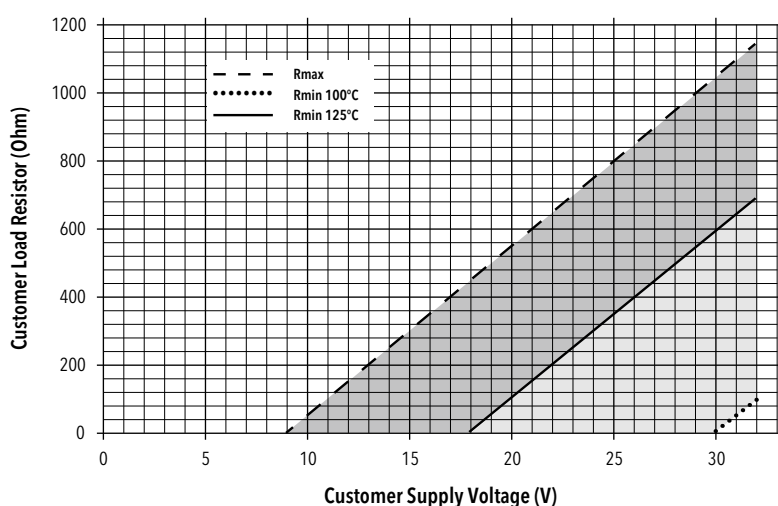

Connection of loads to switching output

Functions switching output

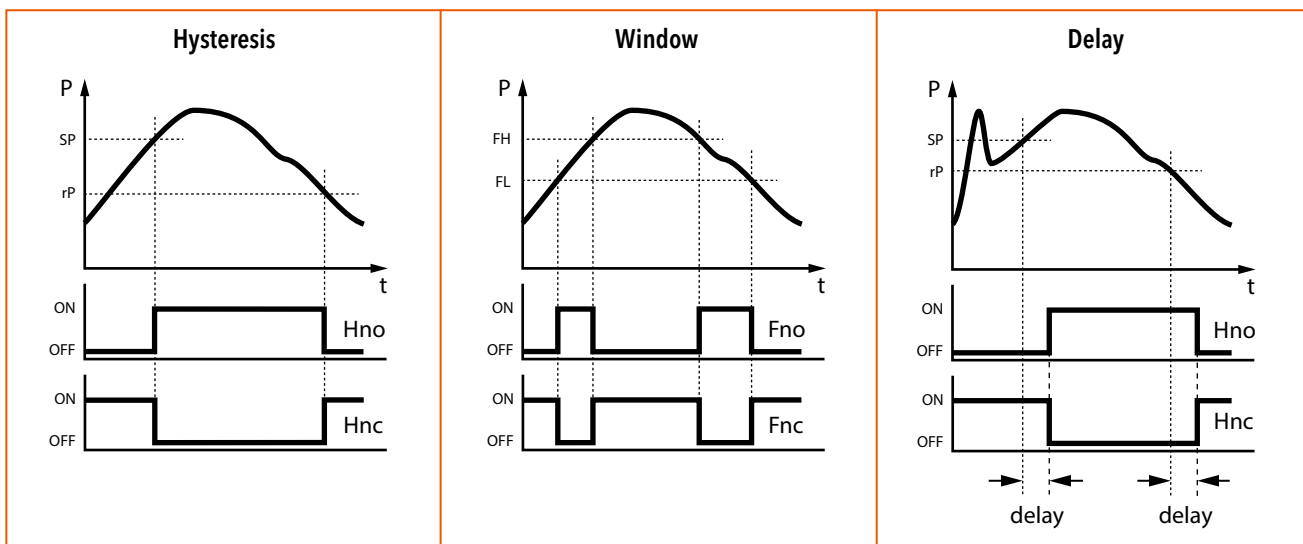

Additional information

Documents

Data sheet	www.trafag.com/H72307
Instructions	www.trafag.com/H73303
Flyer	www.trafag.com/H70697

INDUSTRIAL PRESSURE TRANSMITTER

Swiss based Trafag is a leading international supplier of high quality sensors and monitoring instruments for measurement of pressure and temperature. The economical pressure transmitter ECT 8472 is based on the tried and true ECT line of transmitters. The wide media temperature range from -25 to 125°C in combination with a comprehensive set of features and options makes the ECT 8472 pressure transmitter a versatile solution suitable for most industrial applications.



Applications

- Machine tools
- Hydraulics
- Water treatment

Features

- Relative or absolute pressure measurement
- Titanium version optional
- Excellent media compatibility
- Wide selection of designs and options

Technical Data			
Measuring principle	Thick film on ceramic	Accuracy @ 25°C typ.	± 0.5 % FS typ.
Measuring range	0 ... 1 to 0 ... 400 bar 0 ... 15 to 0 ... 5000 psi	Media temperature	-25°C ... +125°C 400 bar/5000 psi: -10°C ... +125°C
Output signal	4 ... 20 mA, 0 ... 5 VDC, 1 ... 6 VDC, 0 ... 10 VDC, 0.5 ... 4.5 VDC ratiom.	Ambient temperature	-25°C ... +85°C Cable PVC 22: -5°C ... +60°C Cable PUR 24: -20°C ... +70°C Cable Raychem 08: -20°C ... +100°C

Subject to change

Ordering information/type code

				8472 . XX				XX	XX	XX	XX	XX
Measuring range ¹⁾	Pressure measurement range [bar]	Over pressure [bar]	Burst pressure [bar]	Pressure measurement range [psi]	Over pressure [psi]	Burst pressure [psi]						
		0 ... 1.0	2	3	71	0 ... 15	30	40	G1			
	0 ... 1.6	3.2	4.8	73	0 ... 20	45	70	G3				
	0 ... 2.5	5	7.5	75	0 ... 30	60	90	G5				
	0 ... 4	8	12	76	0 ... 50	100	150	G6				
	0 ... 6	12	15	77	0 ... 100	200	250	G7				
	0 ... 10	20	25	78	0 ... 150	300	375	G8				
	0 ... 16	32	40	79	0 ... 250	500	625	G9				
	0 ... 25	50	75	80	0 ... 400	800	1200	H0				
	0 ... 40	80	100	81	0 ... 500	1000	1250	H1				
	0 ... 60	120	180	82	0 ... 1000	2000	3000	H2				
	0 ... 100 ⁴⁾	200	300	83	0 ... 1500 ⁴⁾	3000	4500	H3				
	0 ... 160 ⁴⁾	320	480	85	0 ... 2000 ⁴⁾	4000	6000	H5				
	0 ... 250 ⁴⁾	500	750	74	0 ... 3000 ⁴⁾	6000	9000	G4				
	0 ... 400 ^{2) 4)}	800	1000	84	0 ... 5000 ^{2) 4)}	10000	12500	H4				
Sensor	Relative pressure, Material pressure connection and housing: 1.4305 (AISI303)			57	Absolute pressure, Material pressure connection and housing: 1.4305 (AISI303) ³⁾			87				
	Relative pressure, Material pressure connection and housing: 1.4404/1.4435 (AISI316L) ⁴⁾			59	Absolute pressure, Material pressure connection and housing: 1.4404/1.4435 (AISI316L) ^{3) 4)}			89				
	Relative pressure, Material pressure connection and housing: 1.4462 (AISI318LN) ⁴⁾			52	Absolute pressure, Material pressure connection and housing: 1.4462 (AISI318LN) ^{3) 4)}			82				
	Relative pressure, titanium grade 5 ⁴⁾			53	Absolute pressure, titanium grade 5 ^{3) 4)}			83				
Pressure connection	G1/4" female										10	
	G1/4" male										17	
	G1/2" male DIN3852-A ⁴⁾										21	
	G1/2" male DIN3852-E ⁴⁾										41	
	1/4" NPT male, ANSI B1.20.1 ⁴⁾										30	
	1/8" NPT male, ANSI B1.20.1 ¹¹⁾										43	
	7/16" -20UNF male SAE ^{4) 10)}										42	
	7/16" -20UNF male, DIN3866, max. 40 bar										18	
	7/16" -20UNF female SAE J512 with valve opener, max. 40 bar										24	
	R1/4" male, DIN3858										19	
G3/4" frontal membrane ^{4) 7)}										52		
Electrical connection	Male electrical plug EN 175301-803-A, Mat. PA										05	
	Male electrical plug M12x1, 5-pole, Mat. PA (Old shape), Mat. PBT (New shape)										35	
	Male electrical plug Packard Metri Pack, Mat. PBT ⁹⁾										51	
	Male electrical plug industrial standard (contact distance 9.4 mm) Mat. PBT										01	
	Cable PUR, cable gland PA 6-3, -20°C ... +70°C ^{5) 6)}										24	
	Cable PVC, cable gland PA 6-3, -5°C ... +60°C ^{5) 6) 9)}										22	
	Cable Raychem, cable gland PA 6-3, -20°C ... +100°C ^{5) 6) 9)}										08	
Cable IP68, Mat. PVC, max. 3m, Medium +10°C ... +35°C, Pmax. 1 bar rel./abs. (old version)										68		
Output signal	Signal output	Load resistance	I (supply)	U (supply)								
	4 ... 20 mA	(U _{supply} -9 V) / 20 mA		9 ... 30 VDC							19	
	0 ... 5 VDC	≥ 2.5 kΩ	≤ 10 mA	10 ... 30 VDC							14	
	1 ... 6 VDC	≥ 5.0 kΩ	≤ 10 mA	10 ... 30 VDC							16	
	0 ... 10 VDC	≥ 5.0 kΩ	≤ 10 mA	15 ... 30 VDC							17	
	0.5 ... 4.5 VDC ratiometric	≥ 5.0 kΩ	≤ 10 mA	5 VDC ± 0.25 VDC ratiom.							23	

Accessories	Seal FKM (-20°C ... +125°C)	61
	Seal CR ≤ 100 bar (-25°C ... +100°C) ⁸⁾	62
	Seal EPDM (-25°C ... +125°C)	63
	Pressure peak damping element ø 1.0 mm (for pressure connections 17 and 30)	40
	Pressure peak damping element ø 0.3 mm (for pressure connections 17 and 30)	43
	Pressure peak damping element ø 0.4 mm ⁷⁾	44
	Pressure peak damping element ø 0.5 mm (for pressure connections 17 and 30)	45
	Female electrical connector EN 175301-803-A (DIN43650-A)	58
	Female electrical plug M12x1, 5-pole	33
	Female electrical connector industrial standard	34
	Special electrical connection: Pin 1 + , Pin 2 - (only for output signal 4 ... 20 mA and male electrical plug EN175301-803-A / DIN43650-A)	92
	Special electrical connection: Pin 1 Out , Pin 2 - , Pin 3 + (only for output 14, 16, 17, 23 and male electrical plug EN175301-803-A / DIN43650-A)	98
	Special electrical connection: Pin 1 + , Pin 2 - , Pin 3 Out (only for output signals 14, 16, 17, 23 and male electrical plug EN 175301-803-A / DIN 43650-A)	97
	Special electrical connection: Pin 1 + , Pin 3 - (only for output 4 ... 20 mA and male electrical plug Packard Metri Pack 3-poles)	E4
	Special electrical connection: Pin 1 + , Pin 2 Out Pin 3 - (only for output signals 14, 16, 17, 23 and male electrical plug Packard Metri Pack 3-poles)	99
	Cable length 1.5 m	1M
	Cable length 3.0 m	3M
	Cable length 5.0 m	5M
	Housing nut for electrical connection EN175301-803-A (DIN43650-A) secured with Loctite (max. 85°C)	L9

¹⁾ Extended overpressure as well as customized pressure ranges upon request

²⁾ Media -10°C ... +125°C

³⁾ Absolute ranges max. 40 bar

⁴⁾ Please ask us

⁵⁾ Cable length see accessories (max. length 50 m, in 5-meter sections)

⁶⁾ Protection IP68: Immersion depth max. 3 m, Media +10°C ... +35°C

⁷⁾ Not for sensors 57 and 87, only for pressure ranges ≤ 10 bar or 150 psi

⁸⁾ Only for pressure connections 10, 30, 43, 42, 18, 24, 19

⁹⁾ Pressure ranges > 16 bar (Pressure ranges ≤ 16 bar upon request)

¹⁰⁾ According to norm J1926, max. 35 MPa

¹¹⁾ Only for sensors 59 and 89 and electrical connections 01, 35, 51 (others on request)



Identical construction for refrigeration: Data sheet No. H72323

Standard products (extra short lead time)

Product No.	Type Code	Pressure range [bar]	Over pressure max. [bar]	Signal output	Supply [VDC]
ECT1.0A	8472 71 5717 05 0000 0000 19 58 61	0 ... 1	3.2	4 ... 20 mA	9 ... 30
ECT2.5A	8472 75 5717 05 0000 0000 19 58 61	0 ... 2.5	5	4 ... 20 mA	9 ... 30
ECT6.0A	8472 77 5717 05 0000 0000 19 58 61	0 ... 6	12	4 ... 20 mA	9 ... 30
ECT10.0A	8472 78 5717 05 0000 0000 19 58 61	0 ... 10	20	4 ... 20 mA	9 ... 30
ECT16.0A	8472 79 5717 05 0000 0000 19 58 61	0 ... 16	32	4 ... 20 mA	9 ... 30
ECT25.0A	8472 80 5717 05 0000 0000 19 58 61	0 ... 25	50	4 ... 20 mA	9 ... 30
ECT40.0A	8472 81 5717 05 0000 0000 19 58 61	0 ... 40	80	4 ... 20 mA	9 ... 30
ECT1.0V	8472 71 5717 05 0000 0000 17 58 61	0 ... 1	3.2	0 ... 10 VDC	15 ... 30
ECT2.5V	8472 75 5717 05 0000 0000 17 58 61	0 ... 2.5	5	0 ... 10 VDC	15 ... 30
ECT6.0V	8472 77 5717 05 0000 0000 17 58 61	0 ... 6	12	0 ... 10 VDC	15 ... 30
ECT10.0V	8472 78 5717 05 0000 0000 17 58 61	0 ... 10	20	0 ... 10 VDC	15 ... 30
ECT16.0V	8472 79 5717 05 0000 0000 17 58 61	0 ... 16	32	0 ... 10 VDC	15 ... 30
ECT25.0V	8472 80 5717 05 0000 0000 17 58 61	0 ... 25	50	0 ... 10 VDC	15 ... 30
ECT40.0V	8472 81 5717 05 0000 0000 17 58 61	0 ... 40	80	0 ... 10 VDC	15 ... 30

Specifications		
Accuracy	TEB typ. @ -25 ... +85°C	± 3.0 % FS typ.
	Accuracy @ 25°C typ.	± 0.5 % FS typ.
	NLH @ 25°C (BSL) typ.	± 0.2 % FS typ.
	TC zero point and span typ.	± 0.03 % FS/K typ.
	Long term stability 1 year typ.	± 0.3 % FS typ.
Electrical Data	Output / supply voltage	4 ... 20 mA: 24 (9 ... 30) VDC 0 ... 5 VDC: 24 (10 ... 30) VDC 1 ... 6 VDC: 24 (10 ... 30) VDC 0 ... 10 VDC: 24 (15 ... 30) VDC 0.5 ... 4.5 VDC ratiom.
	Rise time	Typ. 1 ms / 10 ... 90 % nominal pressure
	Switch-on-delay	Max. 1.5 s
	Inverse-polarity protection, short-circuit strenght @ 25°C during 5 min.	4 ... 20 mA: to $U_s = 30$ VDC 0 ... 10 VDC, 0 ... 5 VDC, 1 ... 6 VDC: to $U_s = 30$ VDC 0.5 ... 4.5 VDC ratiometric: to $U_s = 5.25$ VDC
Environmental conditions	Media temperature	-25°C ... +125°C 400 bar/5000 psi: -10°C ... +125°C
	Ambient temperature	-25°C ... +85°C Cable PVC 22: -5°C ... +60°C Cable PUR 24: -20°C ... +70°C Cable Raychem 08: -20°C ... +100°C
	Protection ¹⁾	IP65, IP67, IP68
	Humidity	Max. 95 % relative
	Vibration	4 g (10...2000 Hz)
	Shock	50 g / 8 ms
EMC Protection	Emission	EN/IEC 61000-6-3
	Immunity	EN/IEC 61000-6-2
Mechanical Data	Sensor (wetted parts)	Ceramic, Al ₂ O ₃ (96 %)
	Pressure connection (wetted parts)	57/87: 1.4305 (AISI303) 59/89: 1.4404/1.4435 (AISI316L) 52/82: 1.4462 (AISI318LN) 53/83: Titanium Grade 5
	Housing	57/87: 1.4305 (AISI303) 59/89: 1.4404/1.4435 (AISI316L) 52/82: 1.4462 (AISI318LN) 53/83: Titanium Grade 5
	Sealing	FKM 70 Sh, CR, EPDM
	Male electrical plug	See ordering information
	Weight	~ 110 g
	Mounting torque	15 ... 20 Nm

¹⁾ See electrical connection

Measuring accuracy 0.5 %

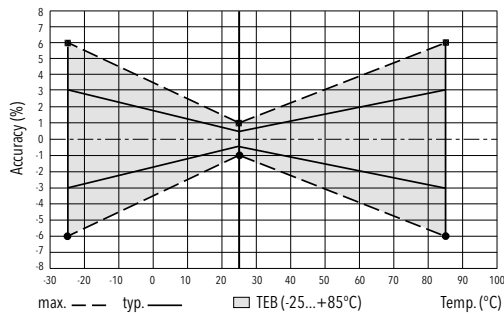

Electrical connection

		Protection / electrical connection					
		IP65*)	IP67*)	IP67*)	IP65	IP67/IP68 max. 3m	IP68 max. 3 m
		Industrial standard EN175301-803A **)	M12x1 **) 5-pole	Packard Metri Pack **) 3-pole	Industrial standard Contact distance 9.4 mm **)	Cable**) 24/22/68	Cable **) 08
		05	35	51	01		
Output signal	<p>8472.xx.xxxx.xx.19</p>	Standard	92		E4		
	<p>8472.xx.xxxx.xx.14/16/17/23</p>	Standard	98	97	99		
						white	red
		2	1	4	1	brown	black
		1	2	1	2	yellow	green
		⊖	⊖	5	⊖		
						white	red
		2	3	2	1	green	white
		3	1	3	3	brown	black
		1	2	2	2	yellow	green
		⊖	⊖	5	3		

*) Provided female connector is mounted according to instructions

**) Ventilation via male electric plug/cable end

***) Only cable versions or female electrical plug with shield connection

Additional information

Documents		
	Data sheet	www.trafag.com/H72324
	Instructions	www.trafag.com/H73324
	Flyer	www.trafag.com/H70662

Dimensions

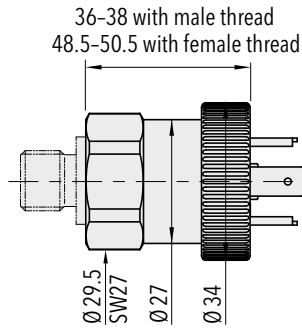

8472.XX.XXXX.05.XX.XX

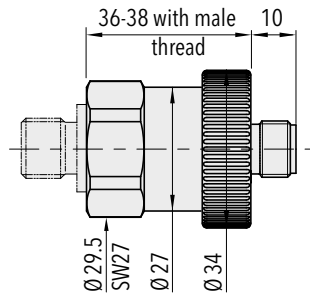

8472.XX.XXXX.35.XX.XX Old shape

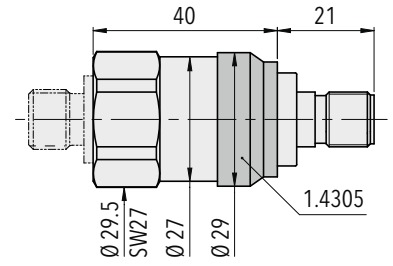

8472.XX.XXXX.35.XX.XX New shape

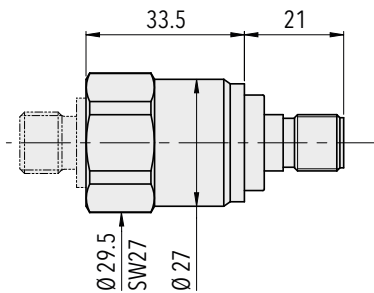

8472.XX.X717.35.XX.XX
8472.XX.X942.35.XX.XX

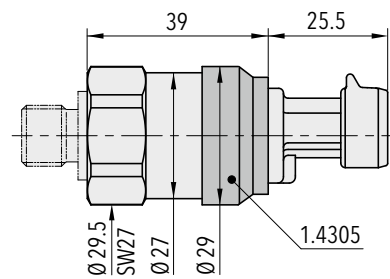

8472.XX.XXXX.51.XX.XX

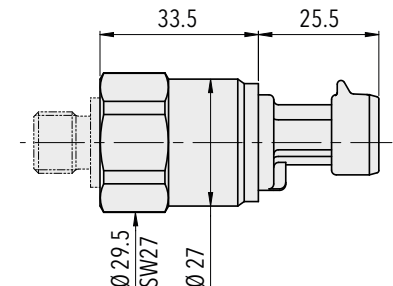

8472.XX.X717.51.XX.XX
8472.XX.X942.51.XX.XX

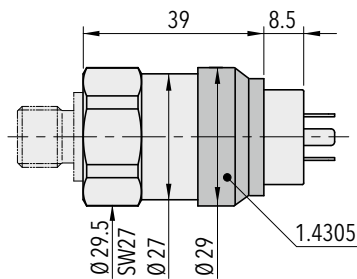

8472.XX.XXXX.01.XX.XX

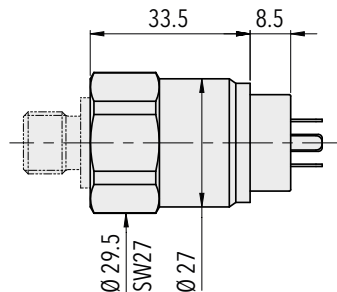

8472.XX.X717.01.XX.XX
8472.XX.X942.01.XX.XX

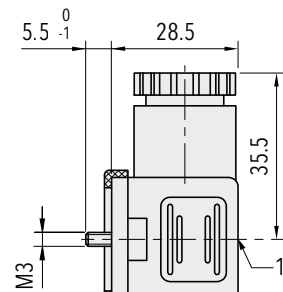

1) Tightening torque 50...60Ncm

8472.XX.XXXX.XX.XX.58

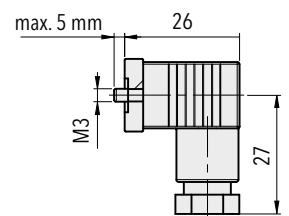

8472.XX.XXXX.XX.XX.34

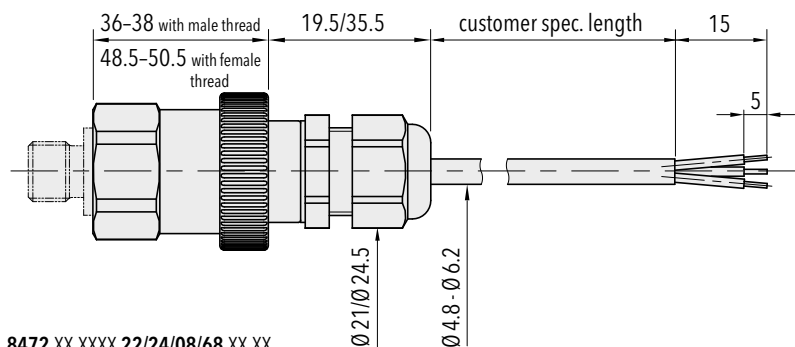

8472.XX.XXXX.22/24/08/68.XX.XX

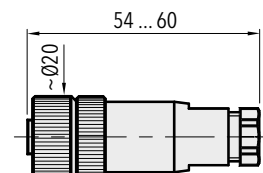

8472.XX.XXXX.XX.XX.33

Dimensions

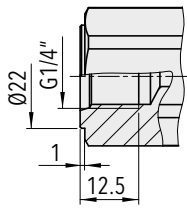

8472.XX.XX10.XX.XX.XX

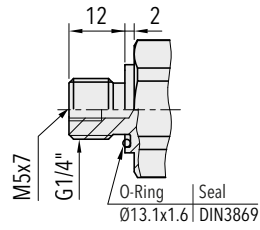

8472.XX.XX17.XX.XX.XX

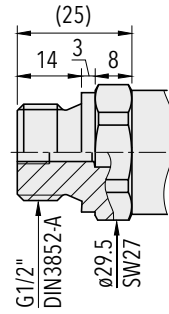

8472.XX.XX21.XX.XX.XX

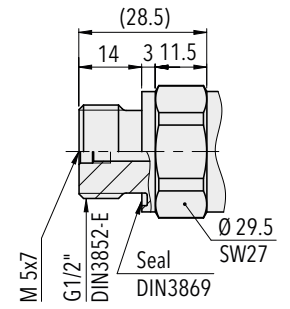

8472.XX.XX41.XX.XX.XX

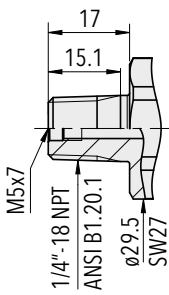

8472.XX.XX30.XX.XX.XX

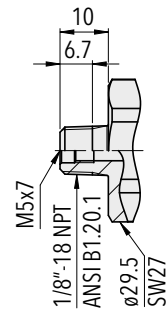

8472.XX.XX943.XX.XX.XX

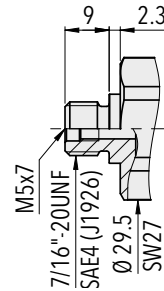

8472.XX.XX42.XX.XX.XX

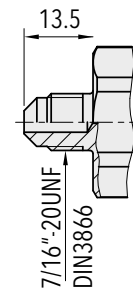

8472.XX.XX18.XX.XX.XX

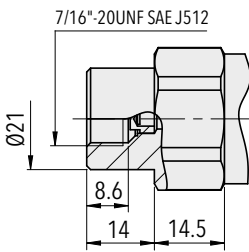

8472.XX.XX24.05.XX.XX.XX

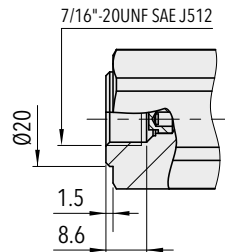

8472.XX.XX24.XX.XX.XX

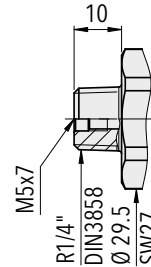

8472.XX.XX19.XX.XX.XX

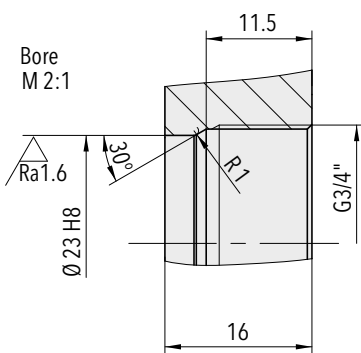

8472.XX.XX52.XX.XX.XX

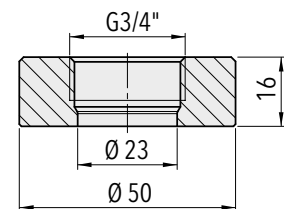
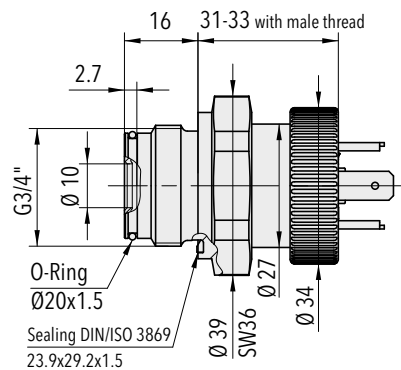

Welding flange for G3/4" frontal membrane (1.4301)
Ordering No. C27805

INDUSTRIAL PRESSURE TRANSMITTER

Swiss based Trafag is a leading international supplier of high quality sensors and monitoring instruments for measurement of pressure and temperature. The economic pressure transmitter ECT 8473 is based on the tried and true ECT line of transmitters with the wide media temperature range from -25 to 125°C. The enhanced accuracy and the low pressure ranges down to 100 mbar in combination with a comprehensive set of features, materials and options makes the ECT 8473 pressure transmitter an ideal and versatile solution suitable for a wide variety of applications.



Applications

- Machine tools
- Hydraulics
- Water treatment

Features

- Economical
- Good media compatibility
- Relative or absolute pressure measurement
- Titanium version optional
- Frontal membrane optional

Technical Data			
Measuring principle	Thick film on ceramic	Accuracy @ 25°C typ.	± 0.3 % FS typ. (± 0.5 % FS typ., ± 1 % FS typ.)
Measuring range	0 ... 0.1 to 0 ... 40 bar 0 ... 1.5 to 0 ... 500 psi	Media temperature	-25°C ... +125°C
Output signal	4 ... 20 mA, 0 ... 5 VDC, 1 ... 6 VDC, 0 ... 10 VDC, 0.5 ... 4.5 VDC ratiom.	Ambient temperature	-25°C ... +85°C Cable PVC 22: -5°C ... +60°C Cable PUR 24: -20°C ... +70°C Cable Raychem 08: -20°C ... +100°C

Subject to change

Ordering information/type code

				8473 . XX	XX	XX	XX	XX	XX
Measuring range ¹⁾	Pressure measurement range [bar]	Over pressure [bar]	Burst pressure [bar]						
	0 ... 0.1	1.2	2	66	0 ... 1.5	15	30	F6	
	0 ... 0.16	1.2	2	67	0 ... 2	15	30	F7	
	0 ... 0.2	1.2	2	68	0 ... 2.5	15	30	F8	
	0 ... 0.4	1.2	2	69	0 ... 5	15	30	F9	
	0 ... 0.6	2	3	70	0 ... 7.5	30	45	G0	
	0 ... 1.0	2	3	71	0 ... 15	30	45	G1	
	0 ... 1.6	3.2	4.8	73	0 ... 20	40	60	G3	
	0 ... 2.5	5	7.5	75	0 ... 30	60	90	G5	
	0 ... 4	8	12	76	0 ... 50	100	150	G6	
	0 ... 6	12	15	77	0 ... 100	200	250	G7	
	0 ... 10	20	25	78	0 ... 150	300	375	G8	
	0 ... 16	32	40	79	0 ... 250	500	625	G9	
	0 ... 25	50	75	80	0 ... 400	800	1200	H0	
	0 ... 40	80	100	81	0 ... 500	1000	1250	H1	
Sensor	Relative pressure, Material pressure connection and housing: 1.4305 (AISI303)		54	Absolute pressure, Material pressure connection and housing: 1.4305 (AISI303) ^{2) 3)}				84	
	Relative pressure, Material pressure connection and housing: 1.4404/1.4435 (AISI316L) ²⁾		56	Absolute pressure, Material pressure connection and housing: 1.4404/1.4435 (AISI316L) ^{2) 3)}				86	
	Relative pressure, Material pressure connection and housing: 1.4462 (AISI318LN) ²⁾		50	Absolute pressure, Material pressure connection and housing: 1.4462 (AISI318LN) ^{2) 3)}				80	
	Relative pressure, titanium grade 5 ²⁾		51	Absolute pressure, titanium grade 5 ^{2) 3)}				81	
Pressure connection	G1/4" female								10
	G1/4" male								17
	G1/2" male DIN3852-A ²⁾								21
	G1/2" male DIN3852-E ²⁾								41
	1/4" NPT male, ANSI B1.20.1 ²⁾								30
	1/8" NPT male, ANSI B1.20.1 ¹⁰⁾								43
	7/16" -20UNF male SAE4 ^{2) 8)}								42
	R1/4" male, DIN3858								19
	G3/4" frontal membrane ^{2) 4)}								52
Electrical connection	Male electrical plug EN 175301-803-A, Mat. PA								05
	Male electrical plug M12x1, 5-pole, Mat. PA (Old shape), Mat. PBT (New shape)								35
	Male electrical plug industrial standard (contact distance 9.4 mm) Mat. PBT								01
	Male electrical plug Packard Metri Pack, Mat. PBT ⁹⁾								51
	Cable PUR, cable gland PA 6-3, -20°C ... +70°C ^{5) 4)}								24
	Cable PVC, cable gland PA 6-3, -5°C ... +60°C ^{5) 4) 9)}								22
	Cable Raychem, cable gland PA 6-3, -20°C ... +100°C ^{5) 4) 9)}								08
Cable IP68, Mat. PVC, max. 3m, Medium +10°C ... +35°C, Pmax. 1 bar rel./abs. (old version)								68	
Output signal	Signal output	Load resistance	I (supply)	U (supply)					
	4 ... 20 mA	(U _{supply} -9 V) / 20 mA		9 ... 30 VDC					19
	0 ... 5 VDC	≥ 2.5 kΩ	≤ 10 mA	10 ... 30 VDC					14
	1 ... 6 VDC	≥ 5.0 kΩ	≤ 10 mA	10 ... 30 VDC					16
	0 ... 10 VDC	≥ 5.0 kΩ	≤ 10 mA	15 ... 30 VDC					17
	0.5 ... 4.5 VDC	≥ 5.0 kΩ	≤ 10 mA	5 VDC ± 0.25 VDC ratiom.					23

ECT 0.3 % (0.5 %, 1.0 %) 8473

8473 . XX XX XX XX XX XX

Accessories	Seal FKM (-20°C ... +125°C)	61
	Seal CR ≤ 100 bar (-25°C ... +100°C) ⁷⁾	62
	Seal EPDM (-25°C ... +125°C)	63
	Pressure peak damping element ø 1.0 mm (for pressure connections 17 and 30)	40
	Pressure peak damping element ø 0.3 mm (for pressure connections 17 and 30)	43
	Pressure peak damping element ø 0.5 mm (for pressure connections 17 and 30)	45
	Female electrical connector EN 175301-803-A (DIN43650-A)	58
	Female electrical plug M12x1, 5-pole	33
	Female electrical connector industrial standard	34
	Special electrical connection: Pin 1 + , Pin 2 - (only for output signal 4 ... 20 mA and male electrical plug EN175301-803-A / DIN43650-A)	92
	Special electrical connection: Pin 1 Out , Pin 2 -, Pin 3 + (only for output 14, 16, 17, 23 and male electrical plug EN175301-803-A / DIN43650-A)	98
	Special electrical connection: Pin 1 + , Pin 2 -, Pin 3 Out (only for output signals 14, 16, 17, 23 and male electrical plug EN 175301-803-A / DIN 43650-A)	97
	Special electrical connection: Pin 1 + , Pin 3 - (only for output 4 ... 20 mA and male electrical plug Packard Metri Pack 3-poles)	E4
	Special electrical connection: Pin 1 + , Pin 2 Out Pin 3 - (only for output signals 14, 16, 17, 23 and male electrical plug Packard Metri Pack 3-poles)	99
	Cable length 1.5 m	1M
	Cable length 3.0 m	3M
	Cable length 5.0 m	5M
	Housing nut for electrical connection EN175301-803-A (DIN43650-A) secured with Loctite (max. 85°C)	L9

¹⁾ Extended overpressure as well as customized pressure ranges upon request

²⁾ Please ask us

³⁾ Only for ranges: ≥ 400 mbar or 5 psi

⁴⁾ Not for sensors 54 and 84, only for pressure ranges ≤ 10 bar or 150 psi

⁵⁾ Cable length see accessories (max. length 50 m, in 5-meter sections)

⁶⁾ Protection IP68: Immersion depth max. 3 m, Media +10°C ... +35°C

⁷⁾ Only for pressure connections 10 and 30

⁸⁾ According to norm J1926, max. 35 MPa

⁹⁾ Pressure ranges > 16 bar (Pressure ranges ≤ 16 bar upon request)

¹⁰⁾ Only for sensors 56 and 86 and electrical connections 01, 35, 51 (others on request)



Identical construction for refrigeration:
Data sheet No. H72323

Standard products (extra short lead time)

Product No.	Type Code	Pressure range [bar]	Over pressure max. [bar]	Pressure connection	Signal output	Accuracy @ 25°C typ. [%]
ECT0.1A	8473 66 5417 05 0000 0000 19 58 61	0 ... 0.1	2	G1/4" male	4 ... 20 mA	1.0
ECT0.2A	8473 68 5417 05 0000 0000 19 58 61	0 ... 0.2	2	G1/4" male	4 ... 20 mA	0.5
ECT0.4A	8473 69 5417 05 0000 0000 19 58 61	0 ... 0.4	2	G1/4" male	4 ... 20 mA	0.5
ECT0.6A	8473 70 5417 05 0000 0000 19 58 61	0 ... 0.6	2	G1/4" male	4 ... 20 mA	0.3
ECT0.1V	8473 66 5417 05 0000 0000 17 58 61	0 ... 0.1	2	G1/4" male	0 ... 10 VDC	1.0
ECT0.2V	8473 68 5417 05 0000 0000 17 58 61	0 ... 0.2	2	G1/4" male	0 ... 10 VDC	0.5
ECT0.4V	8473 69 5417 05 0000 0000 17 58 61	0 ... 0.4	2	G1/4" male	0 ... 10 VDC	0.5
ECT0.6V	8473 70 5417 05 0000 0000 17 58 61	0 ... 0.6	2	G1/4" male	0 ... 10 VDC	0.3
ECTF0.1A	8473 66 5652 05 0000 0000 19 58 61	0 ... 0.1	2	G3/4" frontal membrane	4 ... 20 mA	1.0
ECTF0.2A	8473 68 5652 05 0000 0000 19 58 61	0 ... 0.2	2	G3/4" frontal membrane	4 ... 20 mA	0.5
ECTF0.4A	8473 69 5652 05 0000 0000 19 58 61	0 ... 0.4	2	G3/4" frontal membrane	4 ... 20 mA	0.5
ECTF0.6A	8473 70 5652 05 0000 0000 19 58 61	0 ... 0.6	2	G3/4" frontal membrane	4 ... 20 mA	0.3
ECTF1.0A	8473 71 5652 05 0000 0000 19 58 61	0 ... 1	2	G3/4" frontal membrane	4 ... 20 mA	0.3
ECTF1.6A	8473 73 5652 05 0000 0000 19 58 61	0 ... 1.6	3.2	G3/4" frontal membrane	4 ... 20 mA	0.3
ECTF2.5A	8473 75 5652 05 0000 0000 19 58 61	0 ... 2.5	5	G3/4" frontal membrane	4 ... 20 mA	0.3
ECTF4.0A	8473 76 5652 05 0000 0000 19 58 61	0 ... 4	8	G3/4" frontal membrane	4 ... 20 mA	0.3
ECTF6.0A	8473 77 5652 05 0000 0000 19 58 61	0 ... 6	12	G3/4" frontal membrane	4 ... 20 mA	0.3
ECTF10.0A	8473 78 5652 05 0000 0000 19 58 61	0 ... 10	20	G3/4" frontal membrane	4 ... 20 mA	0.3

Specifications		
Electrical Data	Output / supply voltage	4 ... 20 mA: 24 (9 ... 30) VDC 0 ... 5 VDC: 24 (10 ... 30) VDC 1 ... 6 VDC: 24 (10 ... 30) VDC 0 ... 10 VDC: 24 (15 ... 30) VDC 0.5 ... 4.5 VDC: 5 VDC ratiom.
	Rise time	Typ. 1 ms / 10 ... 90 % nominal pressure
	Switch-on-delay	Max. 1.5 s
	Inverse-polarity protection, short-circuit strenght @ 25°C during 5 min.	4...20 mA: to $U_s = 30$ VDC 0...10 VDC, 0...5 VDC, 1...6 VDC: to $U_s = 30$ VDC 0.5...4.5 VDC ratiometric: to $U_s = 5.25$ VDC
	Environmental conditions	
	Media temperature	-25°C ... +125°C
	Ambient temperature	-25°C ... +85°C Cable PVC 22: -5°C ... +60°C Cable PUR 24: -20°C ... +70°C Cable Raychem 08: -20°C ... +100°C
	Protection ¹⁾	IP65, IP67, IP68
	Humidity	Max. 95 % relative
	Vibration	4 g (10...2000 Hz)
	Shock	50 g / 8 ms
EMC Protection	Emission	EN/IEC 61000-6-3
	Immunity	EN/IEC 61000-6-2
Mechanical Data	Sensor (wetted parts)	Ceramic, Al ₂ O ₃ (96 %)
	Pressure connection (wetted parts)	54/84: 1.4305 (AISI303) 56/86: 1.4404/1.4435 (AISI316L) 50/80: 1.4462 (AISI318LN) 51/81: Titanium Grade 5
	Housing	54/84: 1.4305 (AISI303) 56/86: 1.4404/1.4435 (AISI316L) 50/80: 1.4462 (AISI318LN) 51/81: Titanium Grade 5
	Sealing	FKM 70 Sh, CR, EPDM
	Male electrical plug	See ordering information
	Weight	~ 110 g
	Mounting torque	15 ... 20 Nm

¹⁾ See electrical connection

Accuracy				
Pressure measuring range	[bar]	> 0 ... 0.4	0 ... 0.2	0 ... 0.1
			0 ... 0.4	0 ... 0.16
	[psi]	> 0 ... 5	0 ... 2.5	0 ... 1.5
			0 ... 5	0 ... 2
TEB @ -25 ... +85°C	[% FS typ.]	± 1.0	± 2.0	± 3.0
Accuracy @ +25°C	[% FS typ.]	± 0.3	± 0.5	± 1.0
NLH @ +25°C (BSL)	[% FS typ.]	± 0.2	± 0.3	± 0.3
TC zero point and span	[% FS/K typ.]	± 0.02	± 0.02	± 0.02
Long term stability 1 year @ +25°C	[% FS typ.]	± 0.2	± 0.2	± 0.2

Measuring accuracy 1.0 %

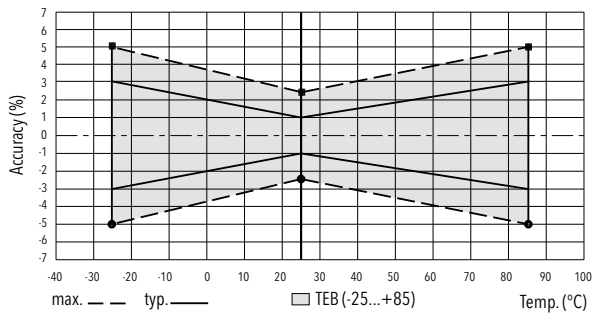

Measuring accuracy 0.5 %

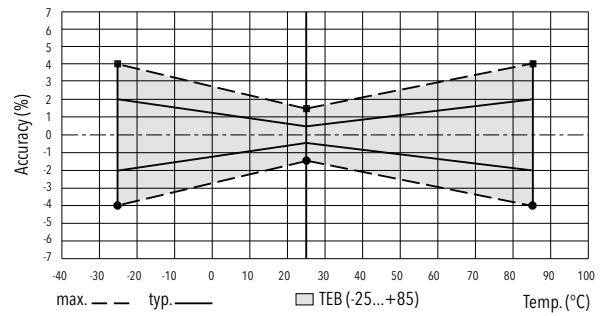

Measuring accuracy 0.3 %

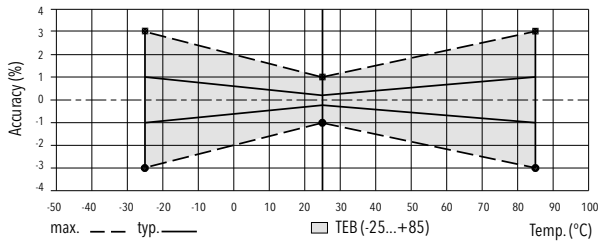

Electrical connection

		Protection / electrical connection					
		IP65*)	IP67*)	IP67*)	IP65	IP67/IP68 max. 3m	IP68 max. 3 m
		Industrial standard EN175301-803A **)	M12x1 **) 5-pole	Packard Metri Pack **) 3-pole	Industrial standard Contact distance 9.4 mm **)	Cable**) 24/22/68	Cable **) 08
		05	35	51	01		
Output signal	<p>8473.xx.xxxx.xx.19</p>	Standard	92		E4		
	<p>8473.xx.xxxx.xx.14/16/17/23</p>	Standard	98	97	99		
						white brown yellow	red black green
						white green brown yellow	red white black green

*) Provided female connector is mounted according to instructions

**) Ventilation via male electric plug/cable end

***) Only cable versions or female electrical plug with shield connection

Additional information

Documents

Data sheet	www.trafag.com/H72326
Instructions	www.trafag.com/H73324
Flyer	www.trafag.com/H70663

Dimensions

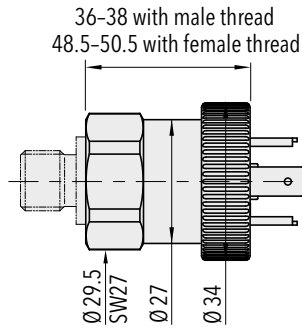

8473.XX.XXXX.05.XX.XX

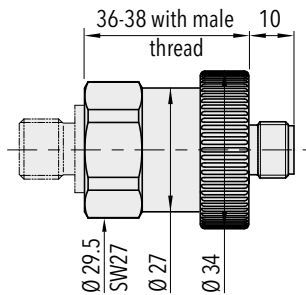

8473.XX.XXXX.35.XX.XX Old shape

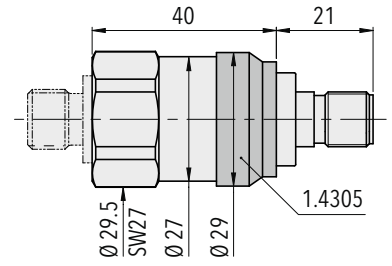

8473.XX.XXXX.35.XX.XX New shape

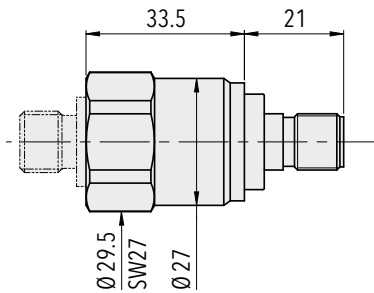

8473.XX.X717.35.XX.XX

8473.XX.X942.35.XX.XX

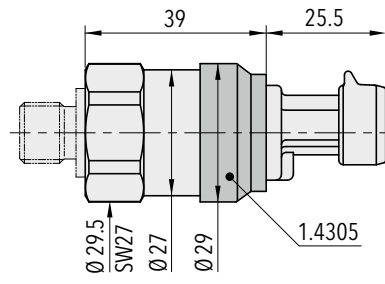

8473.XX.XXXX.51.XX.XX

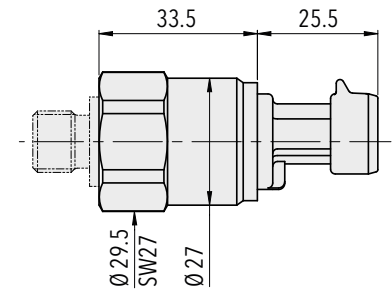

8473.XX.X717.51.XX.XX

8473.XX.X942.51.XX.XX

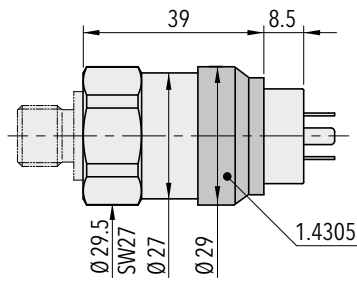

8473.XX.XXXX.01.XX.XX

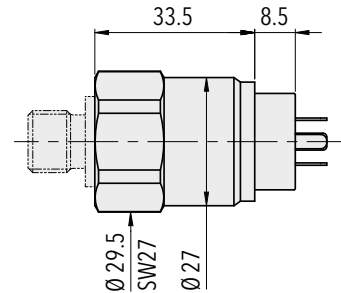

8473.XX.X717.01.XX.XX

8473.XX.X942.01.XX.XX

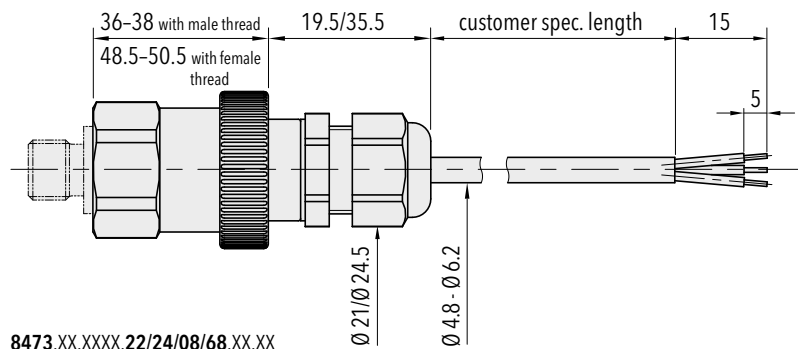

8473.XX.XXXX.22/24/08/68.XX.XX

Dimensions

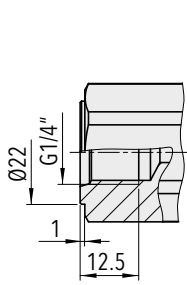

8473.XX.XX10.XX.XX.XX

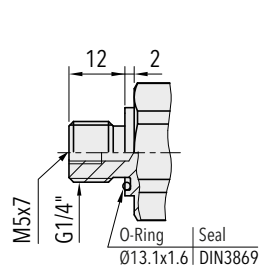

8473.XX.XX17.XX.XX.XX

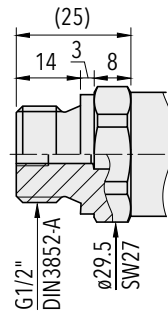

8473.XX.XX21.XX.XX.XX

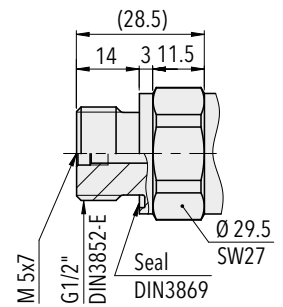

8473.XX.XX41.XX.XX.XX

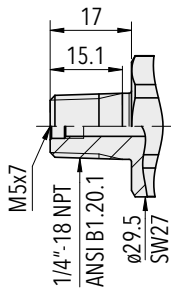

8473.XX.XX30.XX.XX.XX

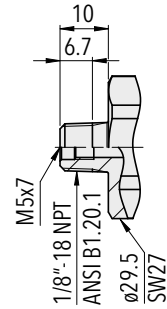

8473.XX.X643.XX.XX.XX

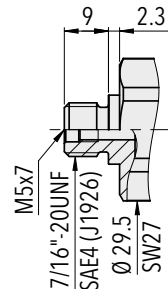

8473.XX.XX42.XX.XX.XX

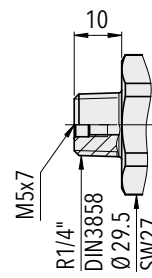

8473.XX.XX19.XX.XX.XX

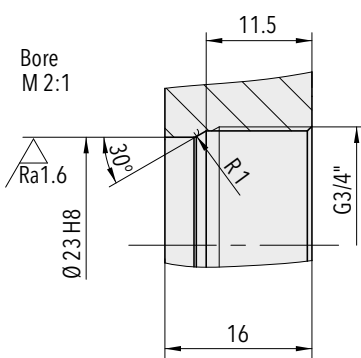

8473.XX.XX52.XX.XX.XX

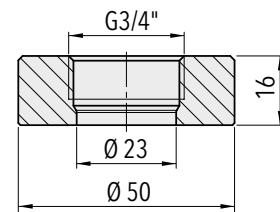
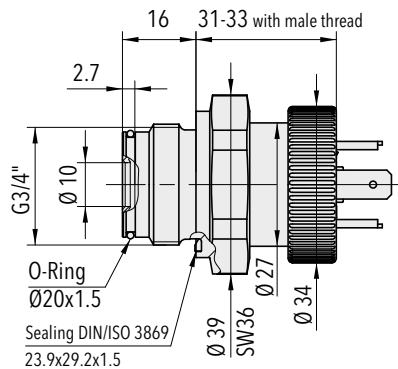

Welding flange for G3/4" frontal membrane (1.4301)
Ordering No. C27805

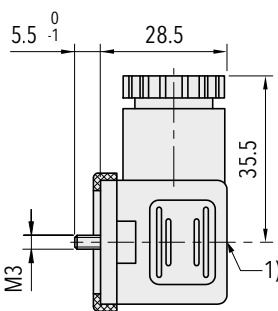

1) Tightening torque 50...60Ncm

8473.XX.XXXX.XX.XX.58

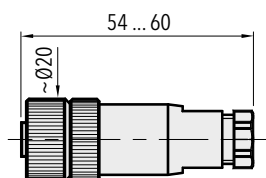

8473.XX.XXXX.XX.XX.33

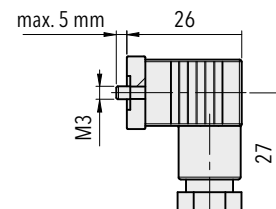

8473.XX.XXXX.XX.XX.34

MARINE PRESSURE TRANSMITTER

Swiss based Trafag is a leading international supplier of high quality sensors and monitoring instruments for measurement of pressure and temperature. The economic pressure transmitter ECTN 8477 is based on the tried and true ECT line of transmitters. The wide media temperature range from -25 to 85°C in combination with a comprehensive set of features and options makes the ECTN 8477 pressure transmitter a versatile solution suitable for marine applications.



Applications

- Shipbuilding
- Engine manufacturing

Features

- Economical
- Good media compatibility
- Relative or absolute pressure measurement
- Titanium version optional

Technical Data			
Measuring principle	Thick film on ceramic	Media temperature	-25°C ... +85°C 400 bar/5000 psi: -10°C ... +85°C
Measuring range	0 ... 1 to 0 ... 400 bar 0 ... 15 to 0 ... 5000 psi	Ambient temperature	-25°C ... +85°C
Output signal	4 ... 20 mA	Approval / conformity	DNV-GL, KRS, RINA
Accuracy @ 25°C typ.	± 0.5 % FS typ.		

Subject to change

Ordering information/type code

				8477 . XX	XX	XX	XX	XX	XX
Measuring range ¹⁾	Pressure measurement range [bar]	Over pressure [bar]	Burst pressure [bar]						
	0 ... 1.0	2	3	71	0 ... 15	30	45	G1	
	0 ... 1.6	3.2	4.8	73	0 ... 20	40	70	G3	
	0 ... 2.5	5	7.5	75	0 ... 30	60	90	G5	
	0 ... 4	8	12	76	0 ... 50	100	150	G6	
	0 ... 6	12	15	77	0 ... 100	200	250	G7	
	0 ... 10	20	25	78	0 ... 150	300	375	G8	
	0 ... 16	32	40	79	0 ... 250	500	625	G9	
	0 ... 25	50	75	80	0 ... 400	800	1200	H0	
	0 ... 40	80	100	81	0 ... 500	1000	1250	H1	
	0 ... 60	120	180	82	0 ... 1000	2000	3000	H2	
	0 ... 100 ⁴⁾	200	300	83	0 ... 1500 ⁴⁾	3000	4500	H3	
	0 ... 160 ⁴⁾	320	480	85	0 ... 2000 ⁴⁾	4000	6000	H5	
	0 ... 250 ⁴⁾	500	750	74	0 ... 3000 ⁴⁾	6000	9000	G4	
	0 ... 400 ^{2) 4)}	800	1000	84	0 ... 5000 ^{2) 4)}	10000	12500	H4	
	Sensor	Relative pressure, 1.4404/1.4435							
Relative pressure, 1.4462 ⁴⁾								52	
Relative pressure, titanium grade 5 ⁴⁾								53	
Absolute pressure, 1.4404/1.4435 ³⁾								89	
Absolute pressure, 1.4462 ^{3) 4)}								82	
Absolute pressure, titanium grade 5 ^{3) 4)}								83	
Pressure connection	G1/4" female ⁴⁾								10
	G1/4" male								17
	G1/2" male DIN3852-A ⁴⁾								21
	G1/2" male DIN3852-E ⁴⁾								41
	1/4" NPT male ⁴⁾								30
Electrical connection	Male electrical plug EN 175301-803-A, Mat. PA								05
Output signal	Signal output	Load resistance	I (supply)	U (supply)					
	4 ... 20 mA	(U _{supply} -9 V) / 20 mA		9 ... 30 VDC	19				
Accessories	Seal FKM (-20°C ... +125°C)								61
	Seal EPDM (-25°C ... +125°C)								63
	Female electrical connector EN 175301-803-A (DIN43650-A)								58
	Pressure peak damping element ø 0.4 mm								44
	Pressure peak damping element ø 1.0 mm (for pressure connections 17 and 30)								40
	Special electrical connection: Pin 1 + , Pin 2 - (only for output signal 4 ... 20 mA and male electrical plug EN175301-803-A / DIN43650-A)								92

¹⁾ Extended overpressure as well as customized pressure ranges upon request

²⁾ Media -10°C ... +85°C

³⁾ Absolute ranges max. 40 bar

⁴⁾ Upon request

Standard products (extra short lead time)

Product No.	Type Code	Pressure range [bar]	Over pressure max. [bar]	Signal output	Supply [VDC]
ECTN1.0A	8477 71 5917 05 0000 0000 19 58 61	0 ... 1	2	4 ... 20 mA	9 ... 30
ECTN2.5A	8477 75 5917 05 0000 0000 19 58 61	0 ... 2.5	5	4 ... 20 mA	9 ... 30
ECTN4.0A	8477 76 5917 05 0000 0000 19 58 61	0 ... 4	8	4 ... 20 mA	9 ... 30
ECTN6.0A	8477 77 5917 05 0000 0000 19 58 61	0 ... 6	12	4 ... 20 mA	9 ... 30
ECTN10.0A	8477 78 5917 05 0000 0000 19 58 61	0 ... 10	20	4 ... 20 mA	9 ... 30
ECTN16.0A	8477 79 5917 05 0000 0000 19 58 61	0 ... 16	32	4 ... 20 mA	9 ... 30
ECTN25.0A	8477 80 5917 05 0000 0000 19 58 61	0 ... 25	50	4 ... 20 mA	9 ... 30
ECTN40.0A	8477 81 5917 05 0000 0000 19 58 61	0 ... 40	80	4 ... 20 mA	9 ... 30

Specifications		
Accuracy	TEB typ. @ -25 ... +85°C	± 3.0 % FS typ.
	Accuracy @ 25°C typ.	± 0.5 % FS typ.
	NLH @ 25°C (BSL) typ.	± 0.2 % FS typ.
	TC zero point and span typ.	± 0.03 % FS/K typ.
	Long term stability 1 year typ.	± 0.3 % FS typ.
Electrical Data	Output / supply voltage	4 ... 20 mA: 24 (9 ... 30) VDC
	Rise time	Typ. 1 ms / 10 ... 90 % nominal pressure
	Switch-on-delay	100 ms
	Inverse-polarity protection, short-circuit strenght @ 25°C during 5 min.	4...20 mA: to $U_s = 30$ VDC
Environmental conditions	Media temperature	-25°C ... +85°C 400 bar/5000 psi: -10°C ... +85°C
	Ambient temperature	-25°C ... +85°C
	Protection ¹⁾	min. IP65
	Humidity	Max. 95 % relative
	Vibration	20 g (10...2000 Hz)
	Shock	50 g / 3 ms
EMC Protection	Emission	EN/IEC 61000-6-3
	Immunity	EN/IEC 61000-6-2
Mechanical Data	Sensor (wetted parts)	Ceramic, Al ₂ O ₃ (96 %)
	Pressure connection (wetted parts)	59/89: 1.4404/1.4435 (AISI316L) 52/82: 1.4462 (AISI318LN) 53/83: Titanium Grade 5
	Housing	59/89: 1.4404/1.4435 (AISI316L) 52/82: 1.4462 (AISI318LN) 53/83: Titanium Grade 5
	Sealing	FKM 70 Sh, EPDM
	Male electrical plug	See ordering information
	Weight	~ 110 g
	Mounting torque	15...20 Nm

¹⁾ See electrical connection

Measuring accuracy 0.5 %

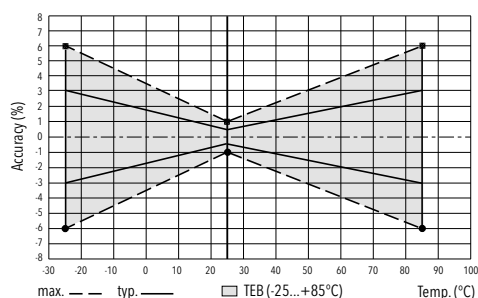

Dimensions

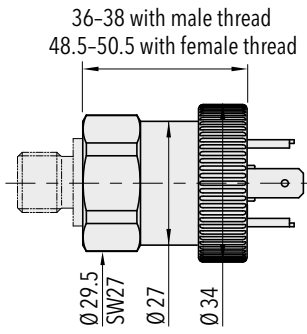

8477.XX.XXXX.05.XX.XX

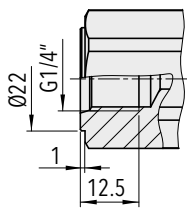

8477.XX.XX10.XX.XX.XX

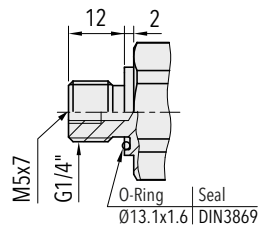

8477.XX.XX17.XX.XX.XX

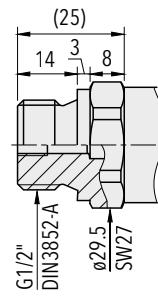

8477.XX.XX21.XX.XX.XX

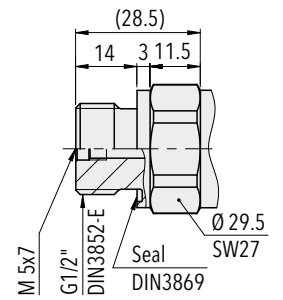

8477.XX.XX41.XX.XX.XX

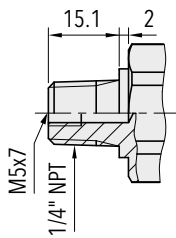

8477.XX.XX30.XX.XX.XX

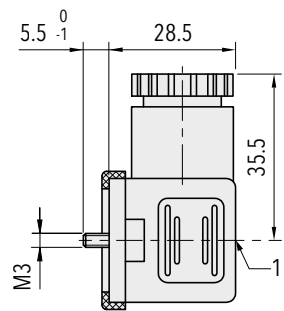

1) Tightening torque 50...60Ncm

8477.XX.XXXX.XX.XX.58

Electrical connection

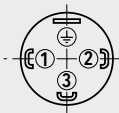
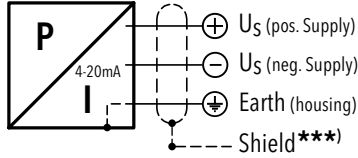
		Protection / electrical connection	
		IP65 ^{*)}	
		Industrial standard EN175301-803A 05 	
Output signal	 <p>8477.xx.xxxx.xx.19</p>	Standard	with accessory 92
		2 1 ⊕	1 2 ⊕

^{*)} Provided female connector is mounted according to instructions

^{***)} Only cable versions or female electrical plug with shield connection

Additional information

Documents		
	Data sheet	www.trafag.com/H72322
	Instructions	www.trafag.com/H73324
	Flyer	www.trafag.com/H70688

RAILWAY PRESSURE TRANSMITTER

Swiss based Trafag is a leading international supplier of high quality sensors and monitoring instruments for measurement of pressure and temperature.



Applications

- Railways

Features

- Dielectrical strength: 710 VDC, meets EN 50155 (Railways)
- Measuring ranges from 100 mbar
- Relative or absolute pressure measurement
- Frontal membrane optional

Technical Data			
Measuring principle	Thick film on ceramic	Media temperature	-25°C ... +125°C
Measuring range	0 ... 0.1 to 0 ... 60 bar 0 ... 1.5 to 0 ... 1000 psi	Ambient temperature	-25°C ... +125°C
Output signal	4 ... 20 mA	Approval / conformity	EN 50155 (Railway) EN 45545-2 (Fire protection)
Accuracy @ 25°C typ.	± 0.3 % FS typ. (± 0.5 % FS typ., ± 1 % FS typ.)		

Subject to change

Ordering information/type code

				8478 .	XX	XX	XX	XX	XX
Measuring range ¹⁾	Pressure measurement range [bar]	Over pressure [bar]	Burst pressure [bar]						
	0 ... 0.1	1.2	2	66					
	0 ... 0.16	1.2	2	67					
	0 ... 0.2	1.2	2	68					
	0 ... 0.4	1.2	2	69					
	0 ... 0.6	2	3	70					
	0 ... 1.0	2	3	71					
	0 ... 1.6	3.2	4.8	73					
	0 ... 2.5	5	7.5	75					
	0 ... 4	8	12	76					
	0 ... 6	12	15	77					
	0 ... 10	20	25	78					
	0 ... 16	32	40	79					
	0 ... 25	50	75	80					
	0 ... 40	80	100	81					
	0 ... 60	120	180	82					
	Sensor	Relative pressure, accuracy class: 0.3 %; Material pressure connection and housing: 1.4305 (AISI303) ^{3) 5)}			54	Relative pressure, accuracy class: 0.5 %; Material pressure connection and housing: 1.4305 (AISI303) ^{4) 5)}			
Relative pressure, accuracy class: 0.3 %; Material pressure connection and housing: 1.4404/1.4435 (AISI316L) ³⁾				56	Relative pressure, accuracy class: 0.5 %; Material pressure connection and housing: 1.4404/1.4435 (AISI316L) ⁴⁾				59
Sensor	Absolute pressure, accuracy class: 0.3 %; Material pressure connection and housing: 1.4305 (AISI303) ^{3) 5)}			84	Absolute pressure, accuracy class: 0.5 %; Material pressure connection and housing: 1.4305 (AISI303) ^{4) 5)}				87
	Absolute pressure, accuracy class: 0.3 %; Material pressure connection and housing: 1.4404/1.4435 (AISI316L) ³⁾			86	Absolute pressure, accuracy class: 0.5 %; Material pressure connection and housing: 1.4404/1.4435 (AISI316L) ⁴⁾				89
Pressure connection	G1/4" male								17
	G3/4" frontal membrane ^{2) 6)}								52
Electrical connection	Male electrical plug EN 175301-803-A, Mat. PA								05
	Male electrical plug M12x1, 5-pole, Mat. PBT								35
Output signal	Signal output	Load resistance	I (supply)	U (supply)					
	4 ... 20 mA	(U _{supply} -9 V) / 20 mA		9 ... 30 VDC					19
Accessories	Seal FKM (-20°C ... +125°C)								61
	Seal CR (-25°C ... +100°C)								62
	Seal EPDM (-25°C ... +125°C)								63
	Pressure peak damping element ø 1.0 mm (for pressure connection 17)								41
	Pressure peak damping element ø 0.4 mm (for pressure connection 17)								44
	Female electrical connector EN 175301-803-A (DIN43650-A)								58
	Female electrical plug M12x1, 5-pole								33
	Special electrical connection: Pin 1 +, Pin 2 - (for male electrical plug EN175301-803-A / DIN43650-A)								92
	Special electrical connection: Pin 1 +, Pin 3 -, Pin 5 Ground (for male electrical plug 35, M12x1, 5-pole)								94
	Housing nut for electrical connection EN175301-803-A (DIN43650-A) secured with Loctite (max. 85°C)								L9

¹⁾ Extended overpressure as well as customized pressure ranges upon request

²⁾ Upon request

³⁾ Max. 40 bar or 500 psi

⁴⁾ ≥ 1 bar

⁵⁾ Only with pressure connection 17 (1.4305)

⁶⁾ Only for pressure ranges ≤ 10 bar or 150 psi

Specifications		
Electrical Data	Output / supply voltage	4 ... 20 mA: 24 (9 ... 30) VDC
	Rise time	Typ. 1 ms / 10 ... 90 % nominal pressure
	Switch-on-delay	100 ms
	Inverse-polarity protection, short-circuit strength @ 25°C during 5 min.	4...20 mA: to $U_s = 30$ VDC
Environmental conditions	Media temperature	-25°C ... +125°C
	Ambient temperature	-25°C ... +125°C
	Protection ¹⁾	IP65, IP67
	Humidity	Max. 95 % relative
	Vibration	15 g RMS (20...2000 Hz) (EN60068-2-64) 25 g sin (80...2000 Hz), 1 oct./min, (1x @ 25°C) (EN60068-2-6)
	Shock	50 g / 11 ms 100 g / 6 ms Male electrical plug M12x1 (EN60068-2-27) ³⁾
EMC Protection	Emission	EN/IEC 61000-6-3 EN50121-3-2
	Immunity	EN/IEC 61000-6-2 EN50121-3-2 ²⁾
Mechanical Data	Sensor (wetted parts)	Ceramic, Al ₂ O ₃ (96 %)
	Pressure connection (wetted parts)	1.4404 (AISI316L)
	Housing	1.4404/1.4435 (AISI316L)
	Sealing	FKM 70 Sh, CR, EPDM
	Male electrical plug	See ordering information
	Weight	~ 110 g
	Mounting torque	15 ... 20 Nm

¹⁾ See electrical connection

²⁾ Surge voltage on shield, shield connected on both sides

³⁾ For electrical connection 35

Accuracy					
		Sensors 57/87/59/89		Sensors 54/84/56/86	
Pressure measuring range	[bar]	≥ 0 ... 1	> 0 ... 0.4	0 ... 0.2	0 ... 0.1
	[psi]	≥ 0 ... 15	> 0 ... 5	0 ... 0.4	0 ... 0.16
				0 ... 2.5	0 ... 1.5
				0 ... 5	0 ... 2
TEB @ -25 ... +85°C	[% FS typ.]	± 3.0	± 1.0	± 2.0	± 3.0
Accuracy @ +25°C	[% FS typ.]	± 0.5	± 0.3	± 0.5	± 1.0
NLH @ +25°C (BSL)	[% FS typ.]	± 0.2	± 0.2	± 0.3	± 0.3
TC zero point and span	[% FS/K typ.]	± 0.03	± 0.02	± 0.02	± 0.02
Long term stability 1 year @ +25°C	[% FS typ.]	± 0.3	± 0.2	± 0.2	± 0.2

Sensors 54/84/56/86 0 ... 0.1 to 0 ... 0.16 bar

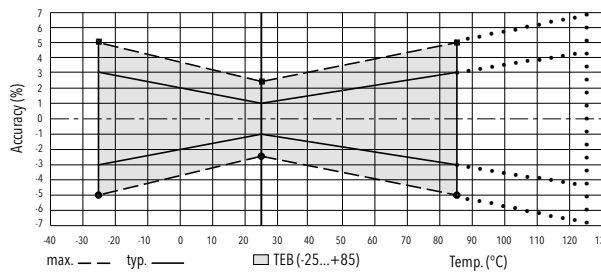

Sensors 54/84/56/86 0 ... 0.2 to 0 ... 0.4 bar

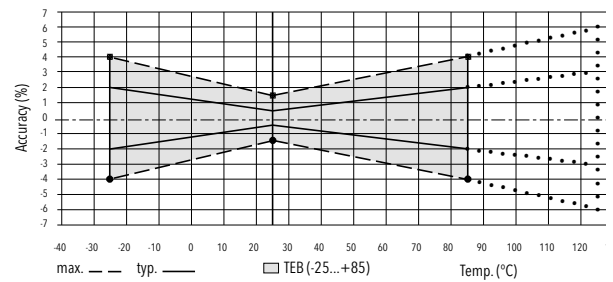

Sensors 54/84/56/86 > 0 ... 0.40 bar

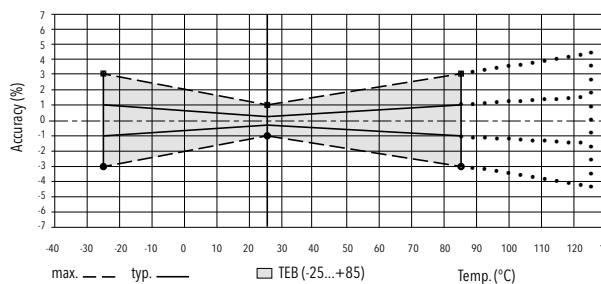

Sensors 57/87/59/89 ≥ 0 ... 1 bar

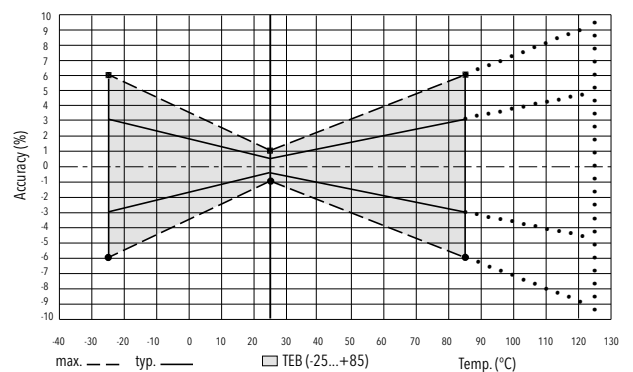

Additional specifications railways

Environmental conditions	Cold	EN 60068-2-1	Ab: -25°C, 2 h (not in operation) Ae: -25°C, 1 h (in operation)
	Dry heat	EN 60068-2-2	Be: 85°C, 6 h (in operation)
	Damp heat, cyclical	EN 60068-2-30	Db: 55°C, variant 1, 2 cycles (2 x 24 h)
	Vibration and shock	EN 61373	Vibration: category 3 Shock: category 3 ^{1) 3)}
	Dielectrical strength	EN 50155	710 VDC
Supply	Resistance of insulation	EN 50155	>100 MΩ, 500 VDC
	Behavior in case of fire (electrical connections 01, 32, 35)	EN 45545-2	Weight: < 10 g Surface: < 0.2 m ²
	Nominal voltage	EN 50155 ²⁾	24 V
Supply	Interruptions of the voltage supply	EN 50155 ²⁾	Class S1
	Switching between two supply voltages	EN 50155 ²⁾	Class C1

¹⁾ In Category 3 the 2010 versions' higher severity levels apply in each case

²⁾ Chapter 5.1 Voltage supply

³⁾ Male electrical plug EN 175301-803-A, cat. 2

Dimensions

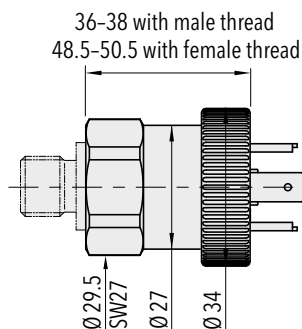

8478.XX.XXXX.05.XX.XX

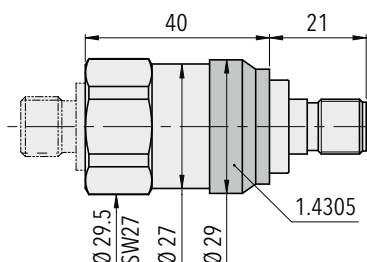

8478.XX.XXXX.35.XX.XX

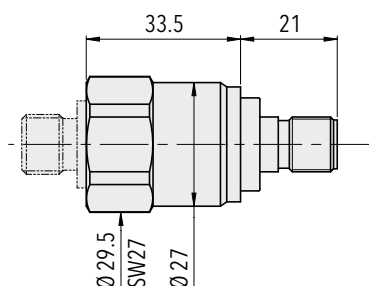

8478.XX.X717.35.XX.XX

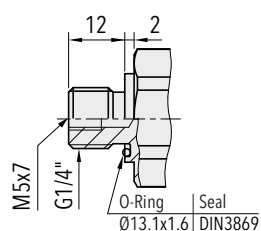

8478.XX.XX17.XX.XX.XX

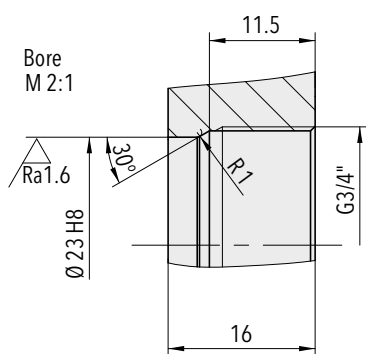

8478.XX.XX52.XX.XX.XX

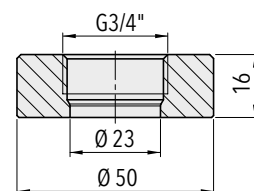
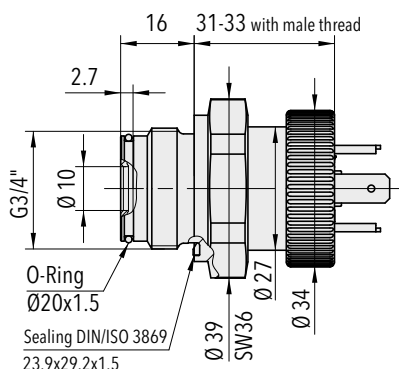

Welding flange for G3/4" frontal membrane (1.4301) Ordering No. C27805

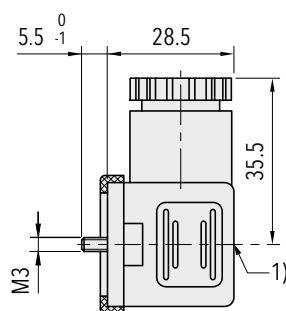

1) Tightening torque 50...60Ncm

8478.XX.XXXX.XX.XX.58

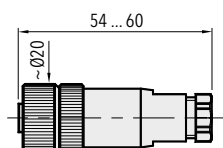

8478.XX.XXXX.XX.XX.33

Electrical connection

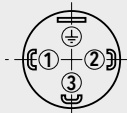
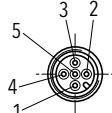
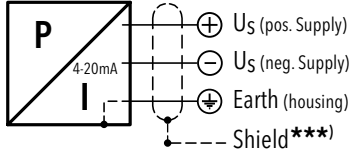
		Protection / electrical connection			
		IP65 ^{*)}		IP67 ^{*)}	
		Industrial standard EN175301-803A		M12x1 5-pole	
		05 		35 	
Output signal		Standard	92	Standard	94
		2 1 ⊕	1 2 ⊕	4 1 5	1 3 5
8478.XX.XXXX.XX.19					

^{*)} Provided female connector is mounted according to instructions

^{**)} Ventilation via male electric plug/cable end

^{***)} Only cable versions or female electrical plug with shield connection

Additional information

Documents

Data sheet	www.trafag.com/H72337
Instructions	www.trafag.com/H73324
Flyer	www.trafag.com/H70604

INDUSTRIAL PRESSURE TRANSMITTER

Swiss based Trafag is a leading international supplier of high quality sensors and monitoring instruments for measurement of pressure and temperature. The industrial pressure transmitter EPI 8287 features the extremely robust and stable thin-film-on-steel sensor element from its well-proven predecessor EPI 8297. In combination with the new inhouse developed ASIC TX it offers a wide temperature range up to 125°C and triple overpressure safety which makes it the perfect solution for a wide range of demanding applications.



Applications

- Machine tools
- Hydraulics
- Industrial applications

Features

- Excellent long-term stability
- High resistance to over pressure
- Completely welded steel sensor system without additional seals
- Compact design
- Different accuracy classes

Technical Data			
Measuring principle	Thin film on steel	Accuracy @ 25°C typ.	± 0.5 % FS typ. ± 0.3 % FS typ.
Measuring range	0 ... 2.5 to 0 ... 600 bar 0 ... 30 to 0 ... 7500 psi	Media temperature	-40°C ... +125°C
Output signal	4 ... 20 mA, 0 ... 5 VDC, 1 ... 6 VDC, 0 ... 10 VDC, 0.5 ... 4.5 VDC ratiometric	Ambient temperature	-40°C ... +125°C Cable PVC: -5°C ... +60°C Cable PUR: -20°C ... +70°C Cable Raychem: -20°C ... +100°C

Subject to change

Ordering information/type code

				8287 . XX	XX	XX	XX	XX	XX
Measuring range ¹⁾	Pressure measurement range [bar]	Over pressure [bar]	Burst pressure [bar]	Pressure measurement range [psi]	Over pressure [psi]	Burst pressure [psi]			
	0 ... 2.5	7.5	50	75	0 ... 30	90	700	G5	
	0 ... 4	12	60	76	0 ... 50	150	850	G6	
	0 ... 6	18	100	77	0 ... 100	300	1450	G7	
	0 ... 10	30	200	78	0 ... 150	450	2500	G8	
	0 ... 16	48	200	79	0 ... 200	600	2500	GA	
	0 ... 25	75	300	80	0 ... 250	750	2500	G9	
	0 ... 40	120	300	81	0 ... 300	900	4000	HA	
	0 ... 60	180	400	82	0 ... 400	1200	4000	H0	
	0 ... 100	300	500	83	0 ... 500	1500	4000	H1	
	0 ... 160	480	750	85	0 ... 1000	3000	5000	H2	
	0 ... 250	750	1000	74	0 ... 1500	4500	7000	H3	
	0 ... 400	1000	2000	84	0 ... 2000	6000	10000	H5	
	0 ... 600	1500	2500	86	0 ... 3000	9000	14500	G4	
	Option 5P:	Fivefold overpressure			0 ... 5000	12500	21750	H4	
	0 ... 2.5	12.5	60	55	0 ... 7500	18750	29000	H6	
	0 ... 4	20	100	56					
	0 ... 6	30	200	57					
	0 ... 10	50	200	58					
	0 ... 16	80	300	59					
	0 ... 25	125	300	60					
	0 ... 40	200	400	61					
	0 ... 60	300	500	62					
	0 ... 100	500	750	63					
0 ... 160	800	1000	65						
Sensor	Relative pressure, accuracy: 0.5 %; Material pressure connection and housing: 1.4542 (AISI630)						25		
	Relative pressure, accuracy: 0.5 %; Material pressure connection and housing: 1.4404 (AISI316L) ^{2) 3) 5)}						35		
	Relative pressure, accuracy: 0.3 %; Material pressure connection and housing: 1.4542 (AISI630)						23		
	Relative pressure, accuracy: 0.3 %; Material pressure connection and housing: 1.4404 (AISI316L) ^{2) 3) 5)}						33		
Pressure connection	G1/4" female ²⁾						10		
	G1/4" male (Seal)						17		
	R1/4" male, DIN3858 ²⁾						19		
	G1/2" male (Manometer) ²⁾						11		
	1/4" NPT male						30		
	1/2" NPT male ²⁾						51		
	M14x1.5 male DIN6149-2 ²⁾						31		
	7/16"-20UNF male, DIN3866 ^{2) 6)}						18		
	7/16"-20UNF male SAE4 (J1926) ^{2) 7)}						42		
	7/16"-20UNF female SAE J512 with valve opener ⁶⁾						24		
Electrical connection	Male electrical plug EN 175301-803-A, Mat. PA						05		
	Male electrical plug M12x1, 5-pole, Mat. PBT						35		
	Male electrical plug Packard Metri Pack, Mat. PBT ⁴⁾						51		
	Male electrical plug industrial standard, contact distance 9.4 mm, Mat. PBT						01		
	Cable PUR, IP68 (Screwed cable gland PA 6-3), -20°C ... +70°C ^{8) 9)}						24		
	Cable PVC, IP68 (Screwed cable gland PA 6-3), -5°C ... +60°C ^{8) 9) 10)}						22		
	Cable Raychem, IP68 (Screwed cable gland PA 6-3), -20°C ... +100°C ^{8) 9) 10)}						08		

Output signal	Signal output	Load resistance	I (supply)	U (supply)	
	4 ... 20 mA	(U _{supply} -9 V) / 20 mA		9 ... 32 VDC	19
	0 ... 5 VDC	> 2.5 kΩ	< 10 mA	9 ... 32 VDC	14
	1 ... 6 VDC	> 5.0 kΩ	< 10 mA	9 ... 32 VDC	16
	0 ... 10 VDC	> 5.0 kΩ	< 10 mA	15 ... 32 VDC	17
	0.5 ... 4.5 VDC ratiometric	> 5.0 kΩ	< 10 mA	5 (4.75 ... 5.25) VDC	23
Accessories	Seal FPM, -18°C ... +125°C ³⁾				61
	Seal EPDM, -40°C ... +125°C ³⁾				63
	Seal NBR, -25°C ... +100°C ³⁾				83
	Pressure peak damping element ø 1.0 mm (for pressure connections 17, 19, 30, 31, 51)				40
	Pressure peak damping element ø 0.4 mm (for pressure connections 17, 19, 30, 31, 51)				44
	Female electrical connector EN 175301-803-A (DIN43650-A)				58
	Female electrical plug M12x1, 5-pole				33
	Female electrical connector industrial standard				34
	Special electrical connection: Pin 1 + , Pin 2 - (only for output signal 4 ... 20 mA and male electrical plug EN175301-803-A / DIN43650-A)				92
	Special electrical connection: Pin 1 Out , Pin 2 - , Pin 3 + (only for output 14, 16, 17 and male electrical plug EN175301-803-A / DIN43650-A)				98
	Special electrical connection: Pin 1 + , Pin 2 - , Pin 3 Out (only for output 14, 16, 17 and male electrical plug EN175301-803-A / DIN43650-A)				97
	Special electrical connection: Pin 1 + , Pin 3 - (only for output 4 ... 20 mA and male electrical plug Packard Metri Pack 3-poles)				E4
	Special electrical connection: Pin 1 + , Pin 2 out Pin 3 - (only for output signals 14, 16, 17 and male electrical plug Packard Metri Pack 3-poles)				99
	Housing nut for electrical connection EN175301-803-A (DIN43650-A) secured with Loctite (max. 85°C)				L9
	Cable length 1.5 m				1M
	Cable length 3.0 m				3M
	Cable length 5.0 m				5M

¹⁾ Customized pressure ranges upon request

²⁾ Upon request

³⁾ Only with pressure connection 17 (G1/4")

⁴⁾ Pressure ranges > 16 bar (Pressure ranges ≤ 16 bar upon request)

⁵⁾ Only for pressure ranges ≥ 10 bar

⁶⁾ Max. allowable pressure range 60 bar at 120 bar overpressure

⁷⁾ According to norm J1926, max. 35 MPa

⁸⁾ Cable length see accessories (max. length 50 m, in 5-meter sections)

⁹⁾ IP68, max. 3 m, Media +10°C ... +35°C

¹⁰⁾ Cable length max. 3 m, for pressure ranges ≤ 16 bar

Standard products (extra short lead time)

Product No.	Type Code	Pressure range [bar]	Over pressure max. [bar]	Signal output	Supply [VDC]
EPI4.0A	8287 76 2517 05 0000 0000 19 44 58 61	0 ... 4	12	4 ... 20 mA	9 ... 32
EPI6.0A	8287 77 2517 05 0000 0000 19 44 58 61	0 ... 6	18	4 ... 20 mA	9 ... 32
EPI10.0A	8287 78 2517 05 0000 0000 19 44 58 61	0 ... 10	30	4 ... 20 mA	9 ... 32
EPI16.0A	8287 79 2517 05 0000 0000 19 44 58 61	0 ... 16	48	4 ... 20 mA	9 ... 32
EPI25.0A	8287 80 2517 05 0000 0000 19 44 58 61	0 ... 25	75	4 ... 20 mA	9 ... 32
EPI40.0A	8287 81 2517 05 0000 0000 19 44 58 61	0 ... 40	120	4 ... 20 mA	9 ... 32
EPI60.0A	8287 82 2517 05 0000 0000 19 44 58 61	0 ... 60	180	4 ... 20 mA	9 ... 32
EPI100.0A	8287 83 2517 05 0000 0000 19 44 58 61	0 ... 100	300	4 ... 20 mA	9 ... 32
EPI250.0A	8287 74 2517 05 0000 0000 19 44 58 61	0 ... 250	750	4 ... 20 mA	9 ... 32
EPI400.0A	8287 84 2517 05 0000 0000 19 44 58 61	0 ... 400	1000	4 ... 20 mA	9 ... 32
EPI600.0A	8287 86 2517 05 0000 0000 19 44 58 61	0 ... 600	1500	4 ... 20 mA	9 ... 32
EPI4.0V	8287 76 2517 05 0000 0000 17 44 58 61	0 ... 4	12	0 ... 10 VDC	15 ... 32
EPI6.0V	8287 77 2517 05 0000 0000 17 44 58 61	0 ... 6	18	0 ... 10 VDC	15 ... 32
EPI10.0V	8287 78 2517 05 0000 0000 17 44 58 61	0 ... 10	30	0 ... 10 VDC	15 ... 32
EPI16.0V	8287 79 2517 05 0000 0000 17 44 58 61	0 ... 16	48	0 ... 10 VDC	15 ... 32
EPI25.0V	8287 80 2517 05 0000 0000 17 44 58 61	0 ... 25	75	0 ... 10 VDC	15 ... 32
EPI40.0V	8287 81 2517 05 0000 0000 17 44 58 61	0 ... 40	120	0 ... 10 VDC	15 ... 32
EPI60.0V	8287 82 2517 05 0000 0000 17 44 58 61	0 ... 60	180	0 ... 10 VDC	15 ... 32
EPI100.0V	8287 83 2517 05 0000 0000 17 44 58 61	0 ... 100	300	0 ... 10 VDC	15 ... 32
EPI250.0V	8287 74 2517 05 0000 0000 17 44 58 61	0 ... 250	750	0 ... 10 VDC	15 ... 32
EPI400.0V	8287 84 2517 05 0000 0000 17 44 58 61	0 ... 400	1000	0 ... 10 VDC	15 ... 32
EPI600.0V	8287 86 2517 05 0000 0000 17 44 58 61	0 ... 600	1500	0 ... 10 VDC	15 ... 32

Specifications		
Electrical Data	Output / supply voltage	4 ... 20 mA: 24 (9...32) VDC 0 ... 5 VDC: 24 (9...32) VDC 1 ... 6 VDC: 24 (9...32) VDC 0 ... 10 VDC: 24 (15...32) VDC 0.5 ... 4.5 VDC ratiometric 10 ... 90 % U_{supply} : 5 ± 0.25 VDC
	Rise time	Typ. 1 ms / 10 ... 90 % nominal pressure
	Switch-on-delay	100 ms
	Inverse-polarity protection, short-circuit strength @ 25°C during 5 min.	4 ... 20 mA: to $U_s = 32$ VDC 0 ... 10 VDC, 0 ... 5 VDC, 1 ... 6 VDC: to $U_s = 28$ VDC 0.5 ... 4.5 VDC ratiometric: to $U_s = 14$ VDC
	Environmental conditions	
	Media temperature	-40°C ... +125°C
	Ambient temperature	-40°C ... +125°C Cable PVC: -5°C ... +60°C Cable PUR: -20°C ... +70°C Cable Raychem: -20°C ... +100°C
	Protection ¹⁾	IP65, IP67, IP68
	Humidity	Max. 95 % relative
	Vibration	15 g RMS (20...2000 Hz) acc.to EN 60068-2-64 25 g sin (80...2000 Hz), 1 oct./min, (1x @ 25°C) acc.to EN 60068-2-6
	Shock	500 g / 1 ms acc.to EN 60068-2-27
EMC Protection	Emission	EN/IEC 61000-6-3
	Immunity	EN/IEC 61000-6-2
Mechanical Data	Sensor (wetted parts)	1.4542 (AISI630)
	Pressure connection (wetted parts)	1.4542 (AISI630) or 1.4404 (AISI316L)
	Housing	1.4542 (AISI630) or 1.4404 (AISI316L)
	Sealing	FPM/EPDM/NBR
	Male electrical plug	See ordering information
	Weight	appr. 80 ... 110 g
	Mounting torque	25 Nm

¹⁾ See electrical connection

Accuracy

		Measuring accuracy 0.5 % Ordering No. 25/35	Measuring accuracy 0.3 % Ordering No. 23/33
TEB @ -25 ... +85°C	[% FS typ.]	± 1.75	± 1.0
Accuracy @ +25°C	[% FS typ.]	± 0.5	± 0.3
NLH @ +25°C (BSL)	[% FS typ.]	± 0.2	± 0.2
TC zero point and span	[% FS/K typ.]	± 0.03	± 0.01
Long term stability 1 year @ +25°C	[% FS typ.]	± 0.1	± 0.2

Measuring accuracy 0.5 %

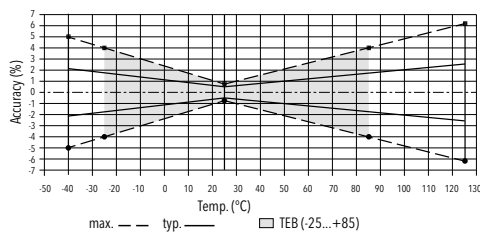

Measuring accuracy 0.3 %

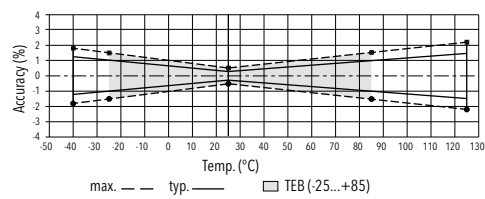

Dimensions

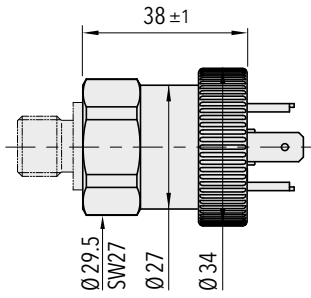

8287.XX.XXXX.05.XX.XX

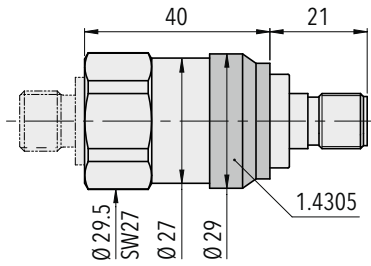

8287.XX.XXXX.35.XX.XX

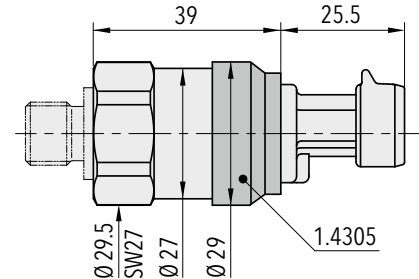

8287.XX.XXXX.51.XX.XX

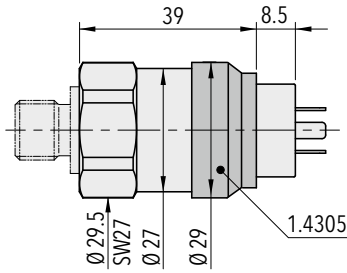

8287.XX.XXXX.01.XX.XX

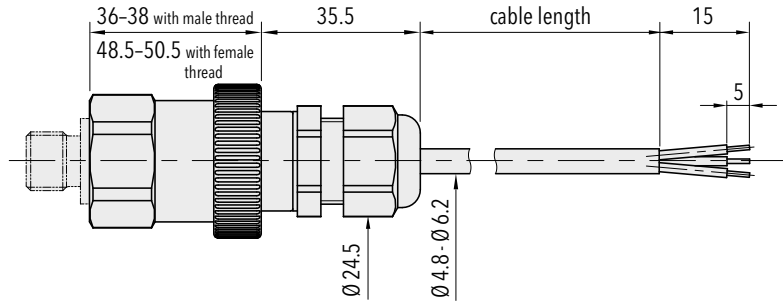

8287.XX.XXXX.24/22/08.XX.XX

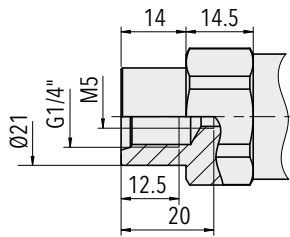

8287.XX.XX10.XX.XX.XX

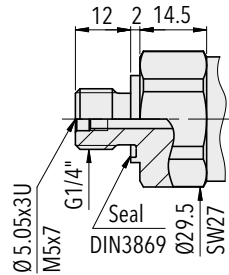

8287.XX.XX17.XX.XX.XX

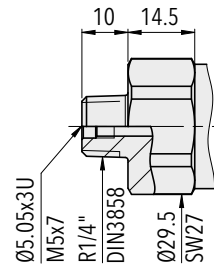

8287.XX.XX19.XX.XX.XX

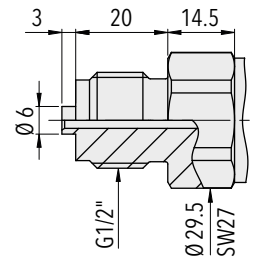

8287.XX.XX11.XX.XX.XX

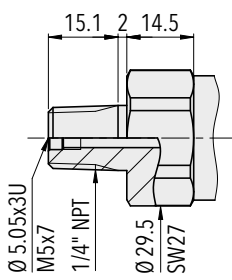

8287.XX.XX30.XX.XX.XX

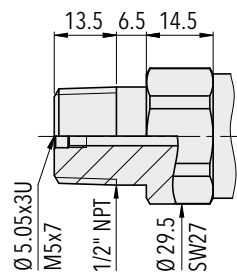

8287.XX.XX51.XX.XX.XX

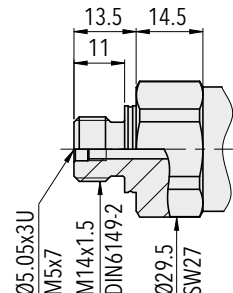

8287.XX.XX31.XX.XX.XX

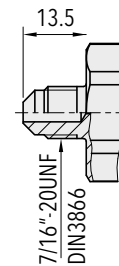

8287.XX.XX18.XX.XX.XX

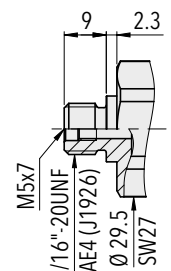

8287.XX.XX42.XX.XX.XX

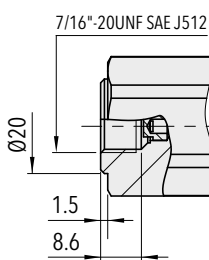

8287.XX.XX24.XX.XX.XX

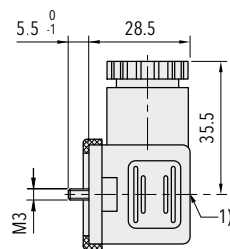

1) Tightening torque 50...60Ncm

8287.XX.XXXX.XX.XX.58

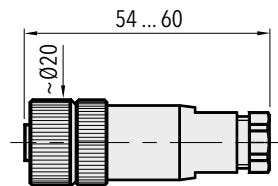

8287.XX.XXXX.XX.XX.33

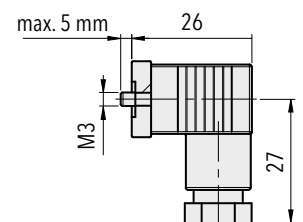

8287.XX.XXXX.XX.XX.34

MARINE PRESSURE TRANSMITTER

Swiss based Trafag is a leading international supplier of high quality sensors and monitoring instruments for measurement of pressure and temperature. The industrial pressure transmitter EPN 8288, like its reliable predecessor the EPN 8298, has an exceptional ruggedness and a strong thin-film-on-steel sensor cell. The triple overpressure safety, a wide temperature range of up to 125°C and the marine certifications make the EPN 8288 the ideal solution for a wide variety of challenging applications.



Applications

- Shipbuilding
- Engine manufacturing
- Machine tools
- Hydraulics



Features

- Excellent long-term stability
- High resistance to over pressure
- Completely welded steel sensor system without additional seals
- Different accuracy classes

Technical Data			
Measuring principle	Thin film on steel	Accuracy @ 25°C typ.	± 0.5 % FS typ. ± 0.3 % FS typ.
Measuring range	0 ... 2.5 to 0 ... 600 bar 0 ... 30 to 0 ... 7500 psi	Media temperature	-40°C ... +125°C
Output signal	4 ... 20 mA, 0 ... 10 VDC 0.5 ... 4.5 VDC ratiometric 	Ambient temperature	-40°C ... +125°C

Subject to change

Ordering information/type code

							8288	XX	XX	XX	XX	XX	
Measuring range ¹⁾	Pressure measurement range [bar]	Over pressure [bar]	Burst pressure [bar]		Pressure measurement range [psi]	Over pressure [psi]	Burst pressure [psi]						
	0 ... 2.5	7.5	50	75	0 ... 30	90	700	G5					
	0 ... 4	12	60	76	0 ... 50	150	850	G6					
	0 ... 6	18	100	77	0 ... 100	300	1450	G7					
	0 ... 10	30	200	78	0 ... 150	450	2500	G8					
	0 ... 16	48	200	79	0 ... 200	600	2500	GA					
	0 ... 25	75	300	80	0 ... 250	750	2500	G9					
	0 ... 40	120	300	81	0 ... 300	900	4000	HA					
	0 ... 60	180	400	82	0 ... 400	1200	4000	HO					
	0 ... 100	300	500	83	0 ... 500	1500	4000	H1					
	0 ... 160	480	750	85	0 ... 1000	3000	5000	H2					
	0 ... 250	750	1000	74	0 ... 1500	4500	7000	H3					
	0 ... 400	1000	2000	84	0 ... 2000	6000	10000	H5					
	0 ... 600	1500	2500	86	0 ... 3000	9000	14500	G4					
					0 ... 5000	12500	21750	H4					
					0 ... 7500	18750	29000	H6					
Sensor	Relative pressure, accuracy: 0.3 %; Material pressure connection and housing: 1.4542 (AISI630)							23					
	Relative pressure, accuracy: 0.5 %; Material pressure connection and housing: 1.4542 (AISI630)							25					
	Relative pressure, accuracy: 0.3 %; Material pressure connection and housing: 1.4404 (AISI316L) ²⁾							33					
	Relative pressure, accuracy: 0.5 %; Material pressure connection and housing: 1.4404 (AISI316L) ²⁾							35					
Pressure connection	G1/4" male (Seal)								17				
	1/4" NPT male ³⁾								30				
	R1/4" male, DIN3858 ³⁾								19				
	1/2" NPT male ³⁾								51				
	M14x1.5 male DIN6149-2 ³⁾								31				
	G1/2" male (Manometer) ³⁾								11				
Electrical connection	Male electrical plug EN 175301-803-A, Mat. PA									05			
Output signal	Signal output	Load resistance	I (supply)	U (supply)									
	4 ... 20 mA	(U _{supply} -9 V) / 20 mA		9 ... 32 VDC						19			
	0 ... 10 VDC	> 5 kΩ	< 10 mA	15 ... 32 VDC						17			
0.5 ... 4.5 VDC ratiometric 	≥ 15.0 kΩ	≤ 12 mA	5 VDC ± 0.25 VDC ratiom.						23				
Accessories	Seal FPM, -18°C ... +125°C											61	
	Seal EPDM, -40°C ... +125°C											63	
	Seal NBR, -25°C ... +100°C											83	
	Pressure peak damping element ø 1.0 mm (for pressure connections 17 and 30)											40	
	Pressure peak damping element ø 0.4 mm (for pressure connections 17 and 30)											44	
	Female electrical connector EN 175301-803-A (DIN43650-A)											58	
	Special electrical connection: Pin 1 +, Pin 2 - (only for output signal 4 ... 20 mA and male electrical plug EN175301-803-A / DIN43650-A)											92	
	Special electrical connection: Pin 1 out, Pin 2 -, Pin 3 + (Only for output 0.5 ... 4.5 VDC and male electrical plug EN175301-803-A / DIN43650-A)											98	
	Special electrical connection: Pin 1 +, Pin 2 -, Pin 3 out (Only for output 0.5 ... 4.5 VDC and male electrical plug EN175301-803-A / DIN43650-A)											97	

¹⁾ Customized pressure ranges upon request

²⁾ Only for pressure ranges ≥ 0 ... 10 bar

³⁾ Upon request

Specifications

Electrical Data	Output / supply voltage	4 ... 20 mA: 24 (9 ... 32) VDC 0 ... 10 VDC 24 (15 ... 32 VDC) 0.5 ... 4.5 VDC: 5 VDC ratiom. 
	Rise time	Typ. 1 ms / 10 ... 90 % nominal pressure
	Switch-on-delay	100 ms
	Inverse-polarity protection, short-circuit strenght @ 25°C during 5 min.	4...20 mA: to $U_s = 32$ VDC 0...10 VDC: to $U_s = 28$ VDC
	Environmental conditions	Media temperature
	Ambient temperature	-40°C ... +125°C
	Protection ¹⁾	IP65
	Humidity	Max. 95 % relative
	Vibration	15 g RMS (20...2000 Hz) acc.to EN 60068-2-64 25 g sin (10...2000 Hz), 1 oct./min, (1x @ 25°C) acc.to EN 60068-2-6
	Shock	500 g / 1 ms acc.to EN 60068-2-27
EMC Protection	Emission	EN/IEC 61000-6-3, IACS UR E10
	Immunity	EN/IEC 61000-6-2, IACS UR E10
Mechanical Data	Sensor (wetted parts)	1.4542 (AISI630)
	Pressure connection (wetted parts)	1.4542 (AISI630) or 1.4404 (AISI316L)
	Housing	1.4542 (AISI630) or 1.4404 (AISI316L)
	Sealing	FPM/EPDM/NBR
	Male electrical plug	See ordering information
	Weight	appr. 80 ... 110 g
	Mounting torque	25 Nm

¹⁾ See electrical connection

Accuracy

		Class 0.5 % Ordering No. 25/35	Class 0.3 % Ordering No. 23/33
TEB @ -25...+85°C	[% FS typ.]	± 1.75	± 0.5
Accuracy @ +25°C	[% FS typ.]	± 0.5	± 0.3
NLH @ +25°C (BSL)	[% FS typ.]	± 0.2	± 0.1
TC zero point and span	[% FS/K typ.]	± 0.03	± 0.005
Long term stability 1 year @ +25°C	[% FS typ.]	± 0.1	± 0.1

Class 0.5 %

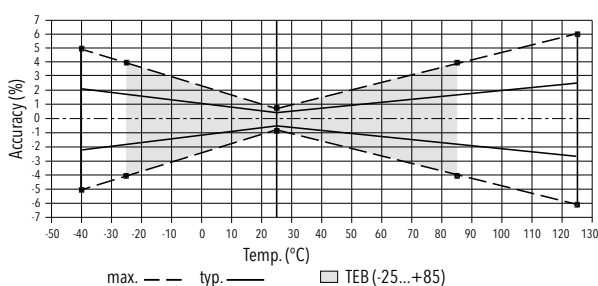

Class 0.3 %

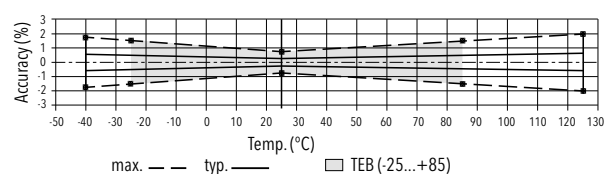

Dimensions

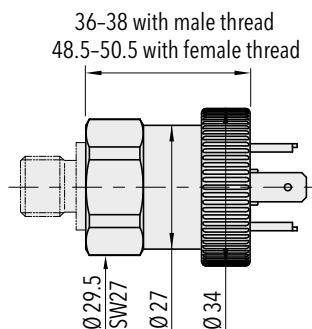

8288.XX.XXXX.05.XX.XX

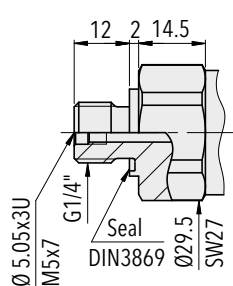

8288.XX.XX17.XX.XX.XX

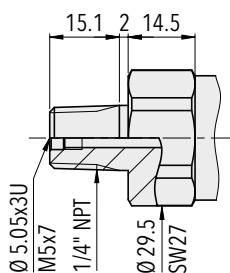

8288.XX.XX30.XX.XX.XX

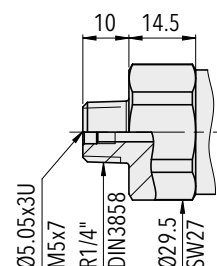

8288.XX.XX19.XX.XX.XX

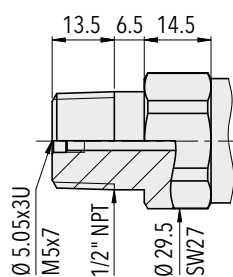

8288.XX.XX51.XX.XX.XX

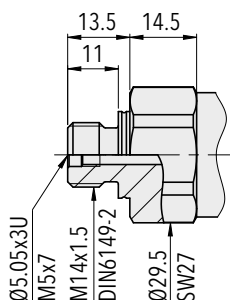

8288.XX.XX31.XX.XX.XX

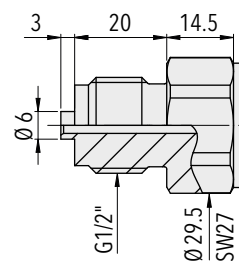

8288.XX.XX11.XX.XX.XX

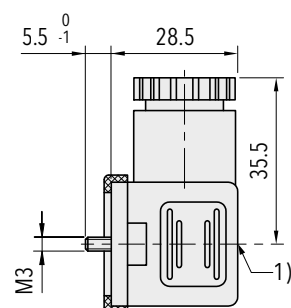

1) Tightening torque 50...60Ncm

8288.XX.XXXX.XX.XX.58

Electrical connection

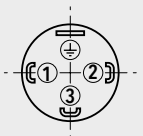
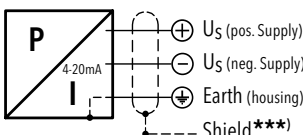
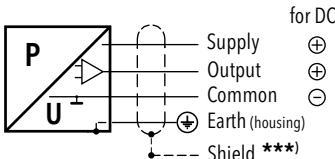
		Protection / electrical connection		
		IP65 ^{*)}		
		Industrial standard EN175301-803A ^{**)}		
		05		
				
Output signal	 <p>8288.xx.xxxx.xx.19</p>	Standard	92	
		2 1 ⊕	1 2 ⊕	
Output signal	 <p>8288.xx.xxxx.xx.17/23</p>	Standard	98	97
		2 3 1 ⊕	3 1 2 ⊕	1 3 2 ⊕

^{*)} Provided female connector is mounted according to instructions

^{**)} Ventilation via male electric plug

^{***)} Only female electrical plug with shield connection

Additional information

Documents

Data sheet	www.trafag.com/H72318
Instructions	www.trafag.com/H73318
Flyer	www.trafag.com/H70693

ENGINE PRESSURE TRANSMITTER

Swiss based Trafag is a leading international supplier of high quality sensors and monitoring instruments for measurement of pressure and temperature. The EPN pressure transmitter offers reliable and accurate pressure measurement over a wide temperature range. Its excellent long-term stability is based on the leading thin-film-on-steel sensor technology from Trafag. Its robust design makes the EPN the perfect choice for demanding applications such as marine and rail industries.



Applications

- Shipbuilding
- Engine manufacturing
- Machine tools
- Hydraulics



Features

- Nominal pressure up to 2500 bar (Common Rail) with high pressure threaded connection
- High vibration resistance
- Good temperature resistance
- Different accuracy classes
- Completely welded steel sensor system without additional seals

Technical Data

Measuring principle	Thin film on steel	Media temperature	-40°C ... +125°C
Measuring range	0 ... 2.5 to 0 ... 2500 bar	Ambient temperature	-40°C ... +125°C
Output signal	4 ... 20 mA 0.5 ... 4.5 VDC ratiometric	Approval / conformity	ABS, BV, CCS, DNV, GL, KRS, LRS, NKK, RINA, RMRS
Accuracy @ 25°C typ.	± 0.5 % FS typ. ± 0.3 % FS typ.		

Subject to change

Ordering information/type code

				8298 . XX	XX	XX	XX	XX	XX
Measuring range ¹⁾	Pressure measurement range	Over pressure	Burst pressure						
	[bar]	[bar]	[bar]						
	0 ... 2.5	5	100	75					
	0 ... 4	8	100	76					
	0 ... 6	12	100	77					
	0 ... 10	20	200	78					
	0 ... 16	32	200	79					
	0 ... 25	50	300	80					
	0 ... 40	80	300	81					
	0 ... 60	120	500	82					
	0 ... 100	200	500	83					
	0 ... 160	320	1000	85					
	0 ... 250	500	1000	74					
	0 ... 400	800	1500	84					
	0 ... 600	1000	2000	86					
	0 ... 1600	3000	4000	89					
	0 ... 2000	3000	4000	90					
	0 ... 2500	3000	4000	91					
Sensor	Relative pressure, accuracy: 0.3 %			23					
	Relative pressure, accuracy: 0.5 %			25					
Pressure connection	G1/4" male (Seal) ²⁾							17	
	R1/4" male DIN3858 ^{2) 4)}							19	
	G1/2" male (Manometer) ²⁾							11	
	1/4" NPT male ^{2) 5)}							30	
	1/2" NPT male ^{2) 5)}							51	
	M14x1.5 male (conical seal: 58°) ³⁾							28	
	M18x1.5 male (conical seal: 58°) ³⁾							29	
Electrical connection	Male electrical plug EN 175301-803-A (DIN43650-A), Mat. PA, normal vibration resistance ≤ 600 bar								04
	Male electrical plug EN 175301-803-A (DIN43650-A), Mat. PA, extended vibration resistance								05
	Male electrical plug: DIN72585 Code 1, Mat.: PBT (Contacts Mat.: Sn)								25
	Male electrical plug MIL-C 26482, 6-pole, metal ⁸⁾								02
	Cable with shield: Material: FDR 25 (Raychem) 4 x 0.5mm ² ⁶⁾								78
Output signal	Signal output	Load resistance	I (supply)	U (supply)					
	4 ... 20mA	(U _{supply} -9 V) / 20 mA		9 ... 32 VDC					19
	0.5 ... 4.5 VDC ⁷⁾	≥ 15.0 kΩ	≤ 12 mA	5 VDC ± 0.25 VDC ratiom.					23
Accessories	Pressure peak damping element ø 1.0 mm								40
	Pressure peak damping element ø 0.3 mm								43
	Pressure peak damping element ø 0.5 mm								45
	Female electrical connector EN 175301-803-A (DIN43650-A)/NBR, -40°C ... +90°C								58
	Female electrical connector MIL-C 26482, 6-pole, metal								32
	Special electrical connection: Pin 1 +, Pin 2 - (only for output signal 4 ... 20 mA and male electrical plug EN175301-803-A / DIN43650-A)								92
	Cable length 1.5 m								1M
	Cable length 3.0 m								3M
	Cable length 5.0 m								5M

¹⁾ Extended overpressure as well as customized pressure ranges upon request

²⁾ For Ranges ≤ 600 bar

³⁾ For ranges > 600 bar

⁴⁾ Only with electrical connection 04

⁵⁾ Please ask us

⁶⁾ Cable length see accessories

⁷⁾ Only with electrical connections 25 and 78

⁸⁾ For pressure ranges < 40 bar upon request

Standard products (extra short lead time)

Product No.	Type Code	Pressure range [bar]	Over pressure max. [bar]	Supply [VDC]	Accuracy @ 25°C typ. [%]
EPN4.0A	8298 76 2517 04 0000 0000 19 43 58	0 ... 4	8	9 ... 32	± 0.5
EPN6.0A	8298 77 2517 04 0000 0000 19 43 58	0 ... 6	12	9 ... 32	± 0.5
EPN10.0A	8298 78 2517 04 0000 0000 19 43 58	0 ... 10	20	9 ... 32	± 0.5
EPN16.0A	8298 79 2517 04 0000 0000 19 43 58	0 ... 16	32	9 ... 32	± 0.5
EPN25.0A	8298 80 2517 04 0000 0000 19 43 58	0 ... 25	50	9 ... 32	± 0.5
EPN40.0A	8298 81 2517 04 0000 0000 19 43 58	0 ... 40	80	9 ... 32	± 0.5
EPN60.0A	8298 82 2517 04 0000 0000 19 43 58	0 ... 60	120	9 ... 32	± 0.5
EPN100.0A	8298 83 2517 04 0000 0000 19 43 58	0 ... 100	200	9 ... 32	± 0.5
EPN250.0A	8298 74 2517 04 0000 0000 19 43 58	0 ... 250	500	9 ... 32	± 0.5
EPN400.0A	8298 84 2517 04 0000 0000 19 43 58	0 ... 400	800	9 ... 32	± 0.5

Specifications		
Electrical Data	Output / supply voltage	4 ... 20 mA: 24 (9 ... 32) VDC 0.5 ... 4.5 VDC: 5 VDC ratiom.
	Rise time	Typ. 1 ms / 10 ... 90 % nominal pressure
Environmental conditions	Media temperature	-40°C ... +125°C
	Ambient temperature	-40°C ... +125°C
	Protection ¹⁾	IP65, IP67, IP69K
	Humidity	Max. 95 % relative
	Vibration	Electrical connection 04/02: 10 g (50...2000 Hz) Electrical connection 05: 15 g (50...2000 Hz) Electrical connection 25: 15 g RMS Electrical connection 78: 20 g RMS
	Shock	50 g / 3 ms
EMC Protection	Emission	EN/IEC 61000-6-4
	Immunity	EN/IEC 61000-6-2
Mechanical Data	Sensor (wetted parts)	1.4542 (AISI630)
	Pressure connection (wetted parts)	1.4542 (AISI630)
	Housing	1.4301 (AISI304) except male electrical plug 04 and 2.5...250bar: 1.4542 (AISI630)
	Sealing	FKM 70 Sh
	Male electrical plug	See ordering information
	Weight	~ 80...110 g
	Mounting torque	25 Nm Pressure connection 28/29: 30 Nm

¹⁾ See electrical connection

Accuracy			
		Measuring accuracy 0.5%	Measuring accuracy 0.3%
		Ordering No. 25	Ordering No. 23
TEB @ -25...+85°C	[% FS typ.]	± 2.0	± 0.5
Accuracy @ +25°C	[% FS typ.]	± 0.5	± 0.3
NLH @ +25°C (BSL)	[% FS typ.]	± 0.2	± 0.1
TC zero point and span	[% FS/K typ.]	± 0.03	± 0.005
Long term stability 1 year @ +25°C	[% FS typ.]	± 0.2	± 0.2

Measuring accuracy 0.5 %

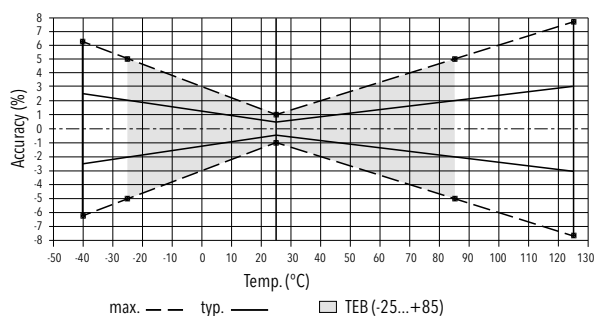

Measuring accuracy 0.3 %

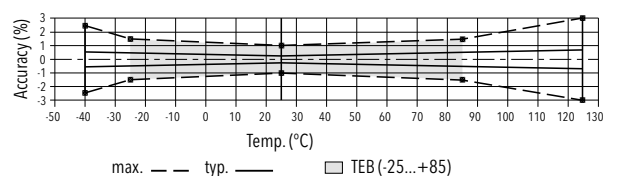

Dimensions

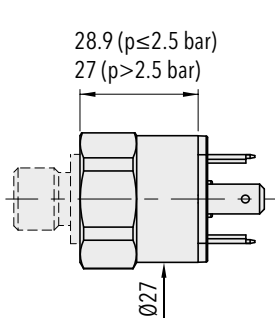

8298.XX.XXXX.04.XX.XX

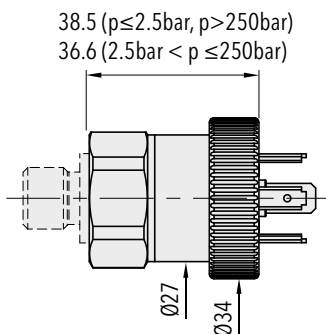

8298.XX.XXXX.05.XX.XX

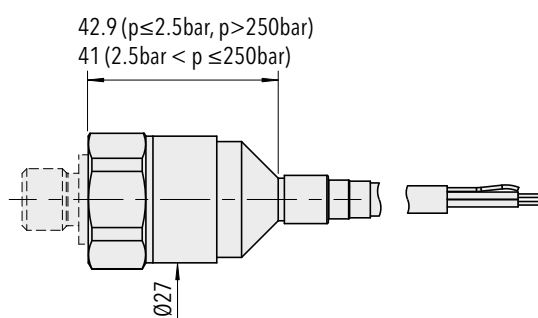

8298.XX.XXXX.78.XX.XX

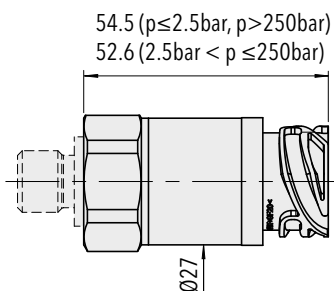

8298.XX.XXXX.25.XX.XX

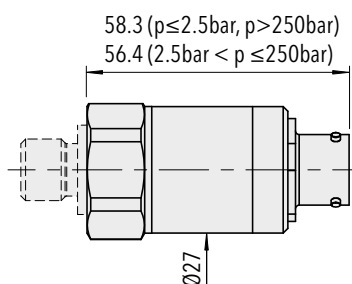

8298.XX.XXXX.02.XX.XX

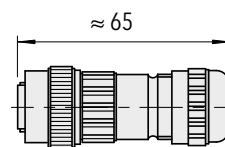

8298.XX.XXXX.02.XX.32

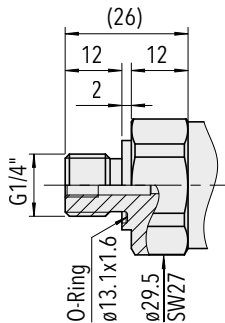

8298.XX.XX17.XX.XX.XX
Pressure ranges: ≤ 600 bar

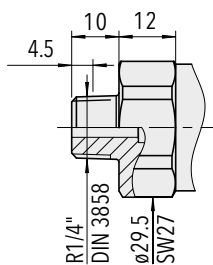

8298.XX.XX19.XX.XX.XX
Pressure ranges: ≤ 600 bar

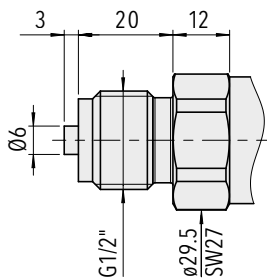

8298.XX.XX11.XX.XX.XX
Pressure ranges: ≤ 600 bar

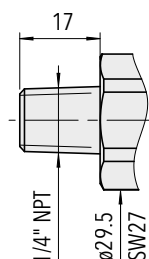

8298.XX.XX30.XX.XX.XX

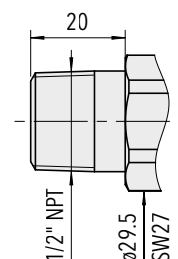

8298.XX.XX51.XX.XX.XX

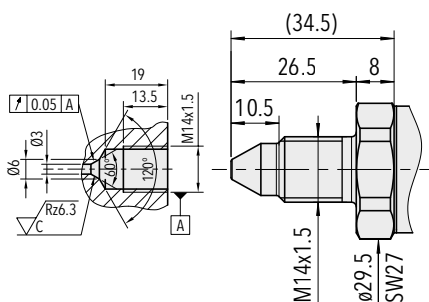

8298.XX.XX28.XX.XX.XX
Pressure ranges: ≤ 2500 bar

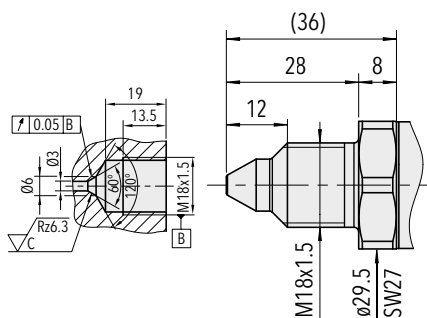



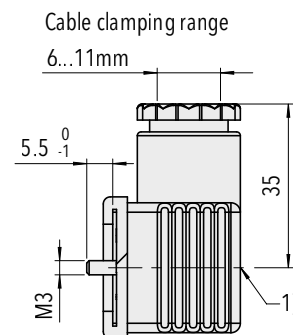

8298.XX.XX29.XX.XX.XX
Pressure ranges: ≤ 2500 bar

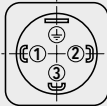

1) Torque moment 50...60 Ncm

8298.XX.XXXX.XX.XX.58

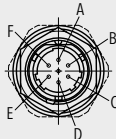
Electrical connection

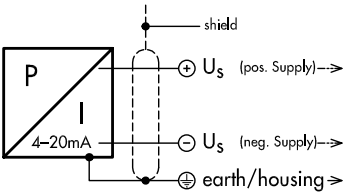
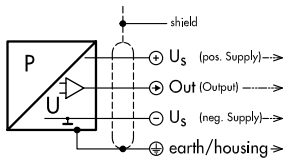
		Protection / electrical connection				
		IP65 ^{*)}	IP69K	IP67 ^{*)}	IP69K ^{*)}	
		Industrial standard EN175301-803A 04/05 	Cable **) 78 Shield 	MIL-C 26482 02 	DIN 72585 ^{**)} Code 1 25 	
Output signal	 8298.XX.XXXX.XX.19	Standard 2 1 ⊕	with accessory 92 1 2 ⊕	brown black yellow / green	A B E	1 4 3
	 8298.XX.XXXX.XX.23			brown blue black yellow / green		1 2 4 3

^{*)} Provided female connector is mounted according to instructions

^{**)} Ventilation via cable end

Additional information

Documents

Data sheet	www.trafag.com/H72312
Instructions	www.trafag.com/H73311
Flyer	www.trafag.com/H70669

RAILWAY PRESSURE TRANSMITTER

Swiss based Trafag is a leading international supplier of high quality sensors and monitoring instruments for measurement of pressure and temperature. The EPR pressure transmitter was specifically designed for the high demand of the railway industry and offers reliable and accurate pressure measurement over a wide temperature range. Its excellent long-term stability is based on the leading thin-film-on-steel sensor technology from Trafag.



Applications

- Railways



Features

- Dielectrical strength: 500 VAC, 50 Hz, meets EN50155 (Railways)
- Compact design
- Good temperature resistance
- Different accuracy classes
- Completely welded steel sensor system without additional seals

Technical Data			
Measuring principle	Thin film on steel	Media temperature	-40°C ... +125°C
Measuring range	0 ... 2.5 to 0 ... 600 bar	Ambient temperature	-40°C ... +125°C
Output signal	4 ... 20 mA	Approval / conformity	EN50155 (Railways)
Accuracy @ 25°C typ.	± 0.5 % FS typ. ± 0.3 % FS typ.		

Subject to change

Ordering information/type code

				8293 . XX	XX	XX	XX	XX	XX
Measuring range ¹⁾	Pressure measurement range [bar]	Over pressure [bar]	Burst pressure [bar]						
	0 ... 2.5	5	100	75					
	0 ... 4	8	100	76					
	0 ... 6	12	100	77					
	0 ... 10	20	200	78					
	0 ... 16	32	200	79					
	0 ... 25	50	300	80					
	0 ... 40	80	300	81					
	0 ... 60	120	500	82					
	0 ... 100	200	500	83					
	0 ... 160	320	1000	85					
	0 ... 250	500	1000	74					
	0 ... 400	800	1500	84					
	0 ... 600	1000	2000	86					
Sensor	Relative pressure, accuracy: 0.3%			23					
	Relative pressure, accuracy: 0.5%			25					
Pressure connection	G1/4" male (O-Ring)				17				
	R1/4" male ²⁾				19				
	1/4"NPT male ³⁾				30				
	1/2"NPT male ³⁾				51				
Electrical connection	Male electrical plug EN 175301-803-A (DIN43650-A), Mat. PA						04		
	Male electrical plug EN 175301-803-A, Mat. PA, Extended vibration resistance						05		
	Male electrical plug MIL-C 26482, 6-pole, metal ⁴⁾						02		
Output signal	Signal output	Load resistance	I (supply)	U (supply)					
	4 ... 20mA	(U _{supply} -9V) / 20mA		9 ... 32 VDC				19	
Accessories	Pressure peak damping element ø 1.0 mm								40
	Pressure peak damping element ø 0.3 mm								43
	Pressure peak damping element ø 0.5 mm								45
	Female electrical connector: EN 175301-803-A (DIN43650-A)/Silicone, -40°C ... +125 °C								56
	Female electrical connector EN 175301-803-A (DIN43650-A)/NBR, -40°C ... +90°C								58
	Female electrical connector MIL-C 26482, 6-pole, metal								32
	Special electrical connection: Pin 1 + , Pin 2 - (only for output signal 4 ... 20 mA and male electrical plug EN175301-803-A / DIN43650-A)								92

¹⁾ Extended overpressure as well as customized pressure ranges upon request

²⁾ Only with electrical connection 04

³⁾ Please ask us

⁴⁾ For pressure ranges < 40 bar upon request

Specifications		
Electrical Data	Dielectric strength	500 VAC, 50 Hz
	Resistance of insulation	> 10 MΩ, 500 VDC
	Output / supply voltage	4...20 mA: 24 (9...32) VDC
	Rise time	Typ. 1 ms/10...90 % nominal pressure
Environmental conditions	Media temperature	-40°C ... +125°C
	Ambient temperature	-40°C ... +125°C
	Protection ¹⁾	IP65, IP67
	Humidity	Max. 95 % relative
	Vibration	Electrical connection 04/02: 10g (20...2000 Hz)/5 grms Electrical connection 05: 15g (20...2000 Hz)
	Shock	50 g / 11 ms
EMC Protection	Emission	EN/IEC 61000-6-4
	Immunity	EN/IEC 61000-6-2
Mechanical Data	Sensor (wetted parts)	1.4542 (AISI630)
	Pressure connection (wetted parts)	Pressure ranges ≤ 250 bar and > 600 bar: 1.4542 (AISI630) Pressure ranges > 250 bar and ≤ 600 bar: 1.4301 (AISI304)
	Housing	1.4301 (AISI304) except male electrical plug 04 and 2.5...250bar: 1.4542 (AISI630)
	Sealing	FKM 70 Sh
	Male electrical plug	See ordering information
	Weight	~ 80...110 g
	Mounting torque	25 Nm

¹⁾ See electrical connection

Accuracy			
		Measuring accuracy 0.5%	Measuring accuracy 0.3%
		Ordering No. 25	Ordering No. 23
TEB @ -25...+85°C	[% FS typ.]	± 2.0	± 0.5
Accuracy @ +25°C	[% FS typ.]	± 0.5	± 0.3
NLH @ +25°C (BSL)	[% FS typ.]	± 0.2	± 0.1
TC zero point and span	[% FS/K typ.]	± 0.03	± 0.005
Long term stability 1 year @ +25°C	[% FS typ.]	± 0.2	± 0.2

Measuring accuracy 0.5 %

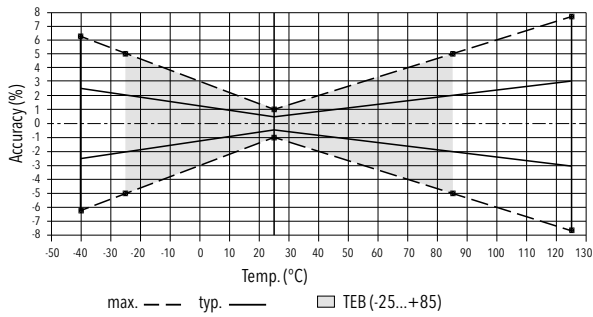

Measuring accuracy 0.3 %

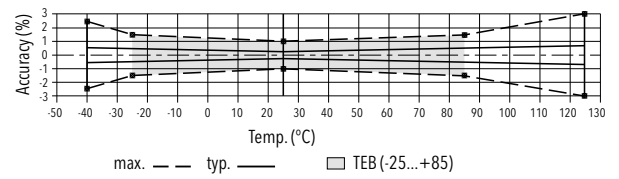

Dimensions

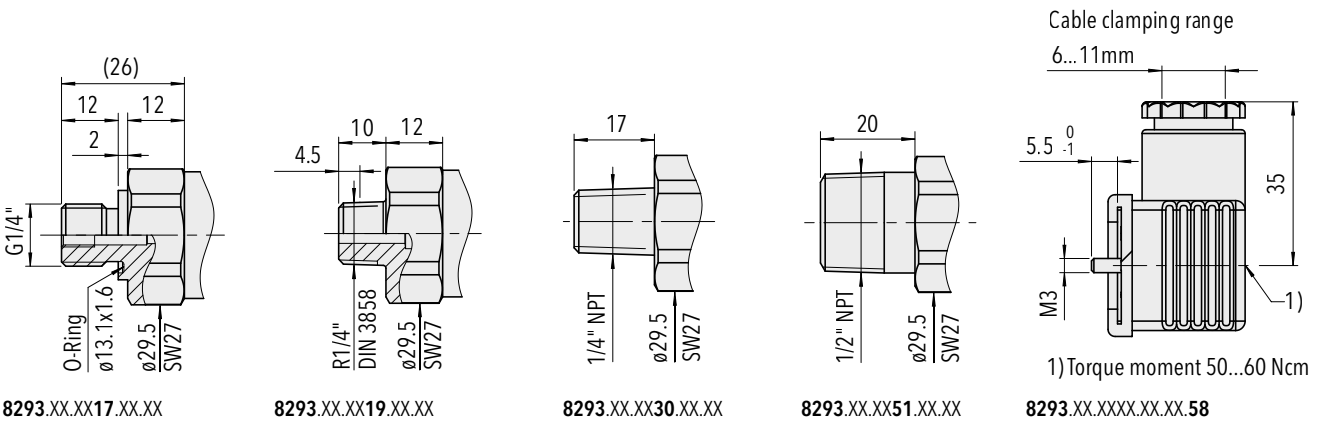
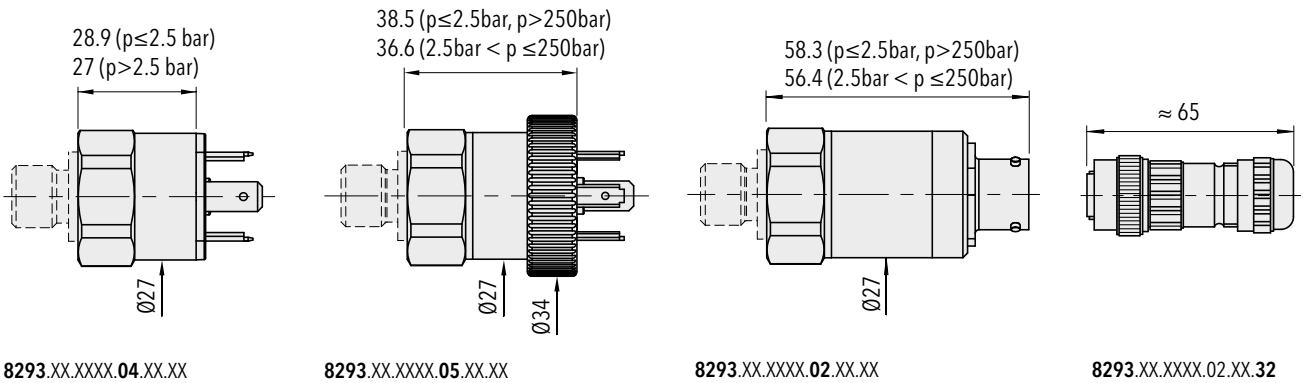

Electrical connection

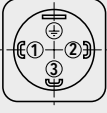
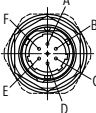
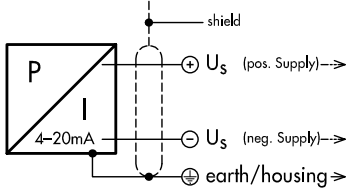
		Protection / electrical connection		
		IP65	IP67*	
		Industrial standard EN175301-803A 04/05 	MIL-C 26482 02 	
Output signal	 <p>8293.XX.XXXX.XX.19</p>	Standard	with accessory 92	
		2 1 ⊕	1 2 ⊕	A B E

*1) Provided female connector is mounted according to instructions

Additional information

Documents		
	Data sheet	www.trafag.com/H72311
	Instructions	www.trafag.com/H73311
	Flyer	www.trafag.com/H70674

PICOTRANS

Swiss based Trafag is a leading international supplier of high quality sensors and monitoring instruments for measurement of pressure and temperature. The NPN pressure transmitter offers reliable and accurate pressure measurement over a wide temperature range. Its excellent long-term stability is based on the leading thin-film-on-steel sensor technology from Trafag. Its robust design and the block design with its optional flange connection makes the NPN the perfect choice for demanding applications such as marine and rail industries.



Applications

- Shipbuilding
- Engine manufacturing
- Railways
- Machine tools
- Hydraulics



Features

- Compact design
- Flange connection (PICO family)
- High vibration resistance
- Good temperature resistance
- Completely welded steel sensor system without additional seals

Technical Data			
Measuring principle	Thin film on steel	Media temperature	-40°C ... +100°C
Measuring range	0 ... 2.5 to 0 ... 250 bar	Ambient temperature	-40°C ... +100°C
Output signal	4 ... 20 mA	Approval / conformity	ABS, BV, CCS, DNV-GL, KRS, LRS, NKK, RINA, RMRS
Accuracy @ 25°C typ.	± 0.5 % FS typ. ± 0.3 % FS typ.		

Subject to change

Ordering information/type code

				8264 . XX	XX	XX	XX	XX	XX
Measuring range ¹⁾	Pressure measurement range [bar]	Over pressure [bar]	Burst pressure [bar]						
	0 ... 2.5	5	100	75					
	0 ... 4	8	100	76					
	0 ... 6	12	100	77					
	0 ... 10	20	200	78					
	0 ... 16	32	200	79					
	0 ... 25	50	300	80					
	0 ... 40	80	300	81					
	0 ... 60	120	500	82					
	0 ... 100	200	500	83					
	0 ... 160 ²⁾	320	1000	85					
0 ... 250 ²⁾	500	1000	74						
Sensor	Relative pressure, accuracy: 0.3 %				23				
	Relative pressure, accuracy: 0.5 %				25				
Pressure connection	G1/4" female					10			
	M10x1 female					17			
	G1/8" female					18			
Electrical connection	Male electrical plug: EN 175301-803-A (DIN43650-A), Mat.: PA						04		
	Cable with shield: Material: FDR 25 (Raychem) 4 x 0.5 mm ² (cable length see "Accessories")						78		
Output signal	Signal output	Load resistance	I (supply)	U (supply)					
	4 ... 20mA	(U _{supply} -9 V) / 20 mA		24 (9 ... 32)VDC				19	
Accessories	Flange connection with O-Ring ³⁾								41
	Pressure peak damping element ø 1.0 mm								40
	Pressure peak damping element ø 0.3 mm								43
	Pressure peak damping element ø 0.5 mm								45
	Welsh plug G1/8"								57
	Welsh plug G1/4"								74
	Female electrical connector EN 175301-803-A (DIN43650-A)/NBR, -40°C ... +90°C								58
	Elbow connector female: 90° EN 175301-803-A (DIN43650-A)/NBR, -40°C ... +90°C								55
	Fixing set								V3
	Special electrical connection: Pin 1 + , Pin 2 - (only for output signal 4 ... 20 mA and male electrical plug EN175301-803-A / DIN43650-A)								92
	Cable length 1.5 m								1M
	Cable length 3.0 m								3M
	Cable length 5.0 m								5M

¹⁾ Extended overpressure as well as customized pressure ranges upon request

²⁾ Only for pressure connection G1/4"

³⁾ Flange (accessory 41) only for pressure ranges ≤ 40 bar

Standard products (extra short lead time)

Product No.	Type Code	Pressure range [bar]	Over pressure max. [bar]	Signal output	Supply [VDC]
NPN4.0A4	8264 76 2510 04 0000 0000 19 58 V3	0...4	10	4...20 mA	24 (9 ... 32)
NPN6.0A4	8264 77 2510 04 0000 0000 19 58 V3	0...6	15	4...20 mA	24 (9 ... 32)
NPN10.0A4	8264 78 2510 04 0000 0000 19 58 V3	0...10	20	4...20 mA	24 (9 ... 32)
NPN16.0A4	8264 79 2510 04 0000 0000 19 58 V3	0...16	32	4...20 mA	24 (9 ... 32)
NPN25.0A4	8264 80 2510 04 0000 0000 19 58 V3	0...25	50	4...20 mA	24 (9 ... 32)
NPN40.0A4	8264 81 2510 04 0000 0000 19 58 V3	0...40	80	4...20 mA	24 (9 ... 32)
NPN4.0AF4	8264 76 2510 04 0000 0000 19 41 58 74 V3	0...4	10	4...20 mA	24 (9 ... 32)
NPN6.0AF4	8264 77 2510 04 0000 0000 19 41 58 74 V3	0...6	15	4...20 mA	24 (9 ... 32)
NPN10.0AF4	8264 78 2510 04 0000 0000 19 41 58 74 V3	0...10	20	4...20 mA	24 (9 ... 32)
NPN16.0AF4	8264 79 2510 04 0000 0000 19 41 58 74 V3	0...16	32	4...20 mA	24 (9 ... 32)
NPN25.0AF4	8264 80 2510 04 0000 0000 19 41 58 74 V3	0...25	50	4...20 mA	24 (9 ... 32)
NPN40.0AF4	8264 81 2510 04 0000 0000 19 41 58 74 V3	0...40	80	4...20 mA	24 (9 ... 32)

Specifications		
Electrical Data	Output / supply voltage	4...20 mA: 24 (9...32) VDC
	Rise time	typ. 1 ms/10...90 % nominal pressure
Environmental conditions	Media temperature	-40°C ... +100°C
	Ambient temperature	-40°C ... +100°C
	Protection ¹⁾	Electrical connection 04: IP65 Electrical connection 78: IP69K
	Humidity	Max. 95 % relative
	Vibration	Electrical connection 04/accessory 55: 10g (50...2000 Hz) Electrical connection 04: 15g (50...2000 Hz) Electrical connection 78: 15g rms
	Shock	50g/ 3 ms
EMC Protection	Emission	EN/IEC 61000-6-4
	Immunity	EN/IEC 61000-6-2
Mechanical Data	Sensor (wetted parts)	1.4542 (AISI630)
	Pressure connection (wetted parts)	1.4542 (AISI630)
	Housing	1.4301 (AISI304)
	Sealing	NBR
	Male electrical plug	See ordering information
	Weight	~ 190...220 g
	Mounting torque	See accessories

¹⁾ Electrical connection 04: Provided female connector is mounted according to instructions

Accuracy			
		Measuring accuracy 0.5% Ordering No. 25	Measuring accuracy 0.3% Ordering No. 23
TEB @ -25...+85°C	[% FS typ.]	± 2.0	± 0.5
Accuracy @ +25°C	[% FS typ.]	± 0.5	± 0.3
NLH @ +25°C (BSL)	[% FS typ.]	± 0.2	± 0.1
TC zero point and span	[% FS/K typ.]	± 0.03	± 0.005
Long term stability 1 year @ +25°C	[% FS typ.]	± 0.2	± 0.2

Measuring accuracy 0.5%

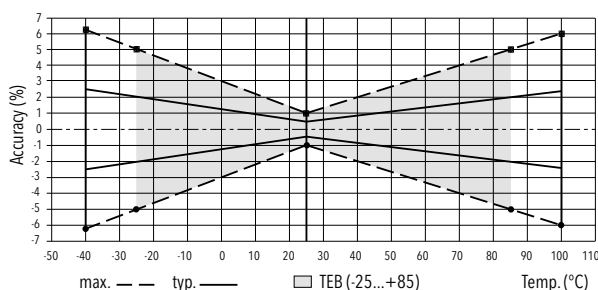

Measuring accuracy 0.3%

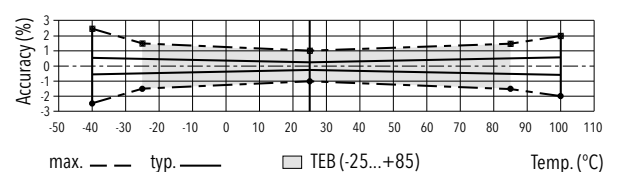

Dimensions

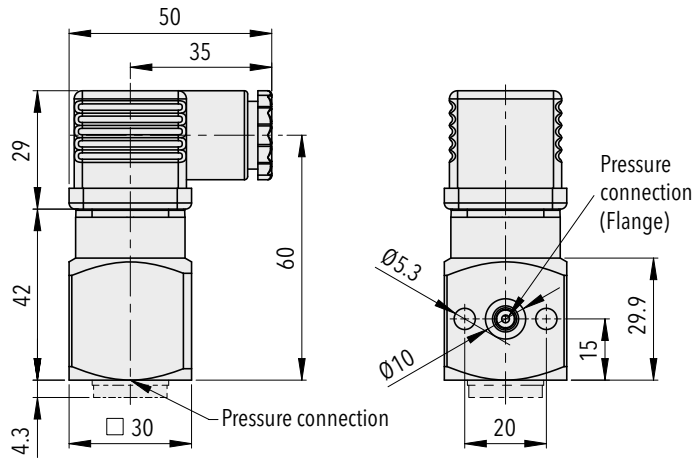

8264.XX.XXXX.04.XX.XX

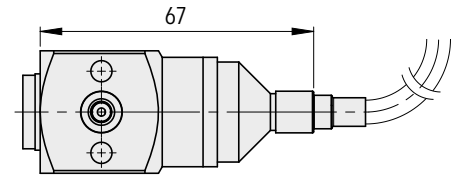

8264.XX.XXXX.78.XX.XX

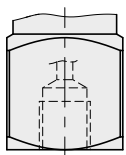

G 1/4"x12: 8264.XX.XX10.XX.XX.XX

G 1/8"x10: 8264.XX.XX18.XX.XX.XX

M10x1x10: 8264.XX.XX17.XX.XX.XX

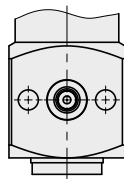

Flange: 8264.XX.XXXX.XX.XX.41

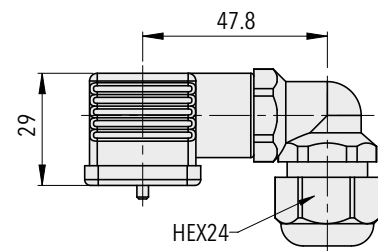

8264.XX.XXXX.XX.XX.55

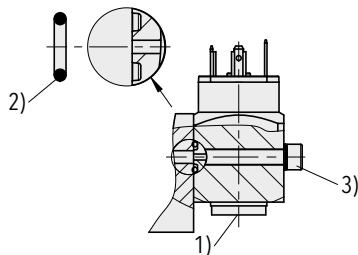

8264.XX.XXXX.XX.XX.41

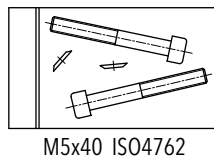

8264.XX.XXXX.XX.XX.V3

1) Torque: G 1/4": $M_A = 32 \dots 40 \text{ Nm}$

2) O-Ring: $\varnothing 6.75 \times 1.78 \text{ NBR 90 Sh}$

3) Fixing screw: M5; property class: 8.8; torque: $4.5 \dots 6 \text{ Nm}$

Electrical connector center screw: max. torque 0.4 Nm

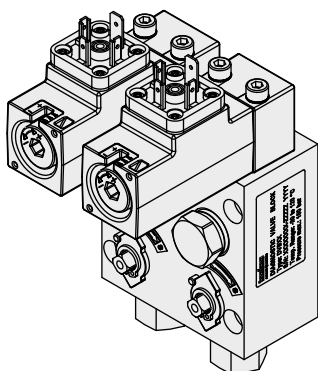

Diagnostic Valve Bloc (DVB)
see specification sheet H72361

Electrical connection

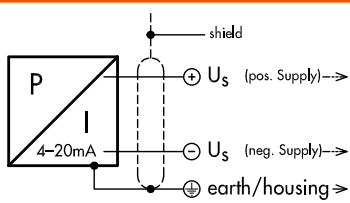
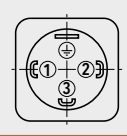
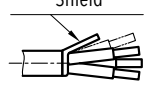
		Protection / electrical connection	
		IP65	IP69K
Output signal  <p>shield</p> <p>U_s (pos. Supply) →</p> <p>U_s (neg. Supply) →</p> <p>earth/housing →</p> <p>4-20mA</p> <p>8264.XX.XXXX.XX.19</p>		Industrial standard EN175301-803A 04 	Cable **) 78 Shield 
		Standard	with accessory 92
	2	1	brown
	1	2	black
	⊕	⊕	yellow / green

***) Ventilation via cable end

Additional information

Documents		
	Data sheet	www.trafag.com/H72313
	Instructions	www.trafag.com/H73313
	Flyer	www.trafag.com/H70673

FLUSH MEMBRANE TRANSMITTER

Swiss based Trafag is a leading international supplier of high quality sensors and monitoring instruments for measurement of pressure and temperature. The Flush Membrane Transmitter FPT is based on Trafag's own thin-film-on-steel technology and the in-house developed high performance ASIC chip electronics. It therefore ensures a high level of accuracy over a wide temperature range and excellent long-term stability in combination with an extraordinary smooth diaphragm surface.



Applications

- Engine manufacturing
- Machine tools
- Hydraulics
- Process technology
- Water treatment
- Food Industry
- Chemical and pharmaceutical industry

Features

- Flush membrane with smooth and plain surface
- Completely welded sensor system
- Very compact design
- Accuracy NLH 0.1% FS typ.
- Excellent long-term stability

Technical Data

Measuring principle	Thin film on steel	Accuracy @ 25°C typ.	± 0.4 % FS
Measuring range	0 ... 0.3 to 0 ... 100 bar 0 ... 15 to 0 ... 1500 psi	Media temperature	-40°C ... +125°C
Output signal	4 ... 20 mA, 0 ... 5 VDC, 1 ... 6 VDC, 0 ... 10 VDC, 0.5 ... 4.5 VDC ratiom.	Ambient temperature	-40°C ... +85°C (Cable PVC 22: -5°C ... +60°C)

Subject to change

Ordering information/type code

							8235 . XX	XX	XX	XX	XX	XX
Measuring range ¹⁾	Pressure measurement range [bar]	Over pressure [bar]	Burst pressure [bar]		Pressure measurement range [psi]	Over pressure [psi]	Burst pressure [psi]					
	0 ... 0.3	3	6	65	0 ... 15	85	170	G1				
	0 ... 0.4	3	6	69	0 ... 30	85	170	G5				
	0 ... 0.6	3	6	70	0 ... 50	115	170	G6				
	0 ... 1	6	12	71	0 ... 100	170	260	G7				
	0 ... 2.5	6	12	75	0 ... 150	290	430	G8				
	0 ... 4	8	12	76	0 ... 250	450	690	G9				
	0 ... 6	12	18	77	0 ... 400	725	1080	H0				
	0 ... 10	20	30	78	0 ... 500	1100	1740	H1				
	0 ... 16	32	48	79	0 ... 1450	2900	4350	H3				
	0 ... 25	50	75	80								
	0 ... 40	80	120	81								
	0 ... 100	200	300	83								
	Sensor	Relative pressure							23			
Pressure connection	G1/2" male, flush membrane							91				
Electrical connection	Male electrical plug EN 175301-803-A (DIN 43650-A) Mat. PA							05				
	Male electrical plug M12x1, 5-pol., Mat. PA							35				
	Male electrical plug, Industrial standard (contact distance 9.4 mm) Mat. PBT							01				
	Male electrical plug Packard Metri Pack							51				
	Cable IP67 (cable length see "Accessories") Mat. PVC (cable gland PA6-3), -5°C ... +60°C ²⁾							22				
	Cable IP68 max. 3m, medium +10°C...+35°C, max. 1 bar relative							68				
Output signal	Signal output	Load resistance		I (supply)	U (supply)							
	4 ... 20mA	(U _{supply} -9 V) / 20 mA			9 ... 30 VDC						19	
	0 ... 5 VDC	> 2.5 kΩ		< 10 mA	10 ... 30 VDC						14	
	1 ... 6 VDC	> 5.0 kΩ		< 10 mA	10 ... 30 VDC						16	
	0 ... 10 VDC	> 5.0 kΩ		< 10 mA	15 ... 30 VDC						17	
	0.5 ... 4.5 VDC	> 5.0 kΩ		< 10 mA	5 VDC ± 0.25 VDC ratiom.						23	
Accessories	Sealing Ring DIN 3869, Mat. FPM (FKM) -15°C ... +125°C							61				
	Sealing Ring DIN 3869, Mat. NBR, -25°C ... +100°C							69				
	Female electrical connector EN 175301-803-A (DIN43650-A)/NBR, -40°C ... +90°C							58				
	Female electrical plug M12x1, 5-pole							33				
	Female electrical connector industrial standard							34				
	Special electrical connection: Pin 1 + , Pin 2 - (only for output signal 4 ... 20 mA and male electrical plug EN175301-803-A / DIN43650-A) ²⁾							92				
	Special electrical connection: Pin 1 Out , Pin 2 -, Pin 3 + (only for output 14, 16, 17, 23 and male electrical plug EN175301-803-A / DIN43650-A) ²⁾							98				
	Special electrical connection: Pin 1 + , Pin 2 -, Pin 3 out (Only for output 0...5VDC, 1...6VDC, 0...10VDC, 0.5...4.5VDC and male electrical plug EN175301-803-A / DIN43650-A) ²⁾							97				
	Special electrical connection: Pin 1 + , Pin 2 -, Pin 3 GR (Only for output 4...20mA and male electrical plug M12x1, 5-pol.) ²⁾							94				
	Special electrical connection: Pin 1 + , Pin 2 - (Only for male electrical plug Packard Metri Pack 3-pol.) ²⁾							99				
	Membrane electropolished Ra=0.4µm							EP				
	Cable length 1.5 m							1M				
	Cable length 3.0 m							3M				
	Cable length 5.0 m							5M				

Standard products (extra short lead time)

Product No.	Type Code	Pressure range [bar]	Over pressure max. [bar]	Signal output	Accuracy @ 25°C typ. [%]
FPT1.0A	8235 71 2391 05 0000 0000 19 58 61	0 ... 1	6	4 ... 20 mA	± 0.4
FPT2.5A	8235 75 2391 05 0000 0000 19 58 61	0 ... 2.5	5	4 ... 20 mA	± 0.4
FPT4.0A	8235 76 2391 05 0000 0000 19 58 61	0 ... 4	8	4 ... 20 mA	± 0.4
FPT6.0A	8235 77 2391 05 0000 0000 19 58 61	0 ... 6	12	4 ... 20 mA	± 0.4
FPT10.0A	8235 78 2391 05 0000 0000 19 58 61	0 ... 10	20	4 ... 20 mA	± 0.4
FPT16.0A	8235 79 2391 05 0000 0000 19 58 61	0 ... 16	32	4 ... 20 mA	± 0.4
FPT25.0A	8235 80 2391 05 0000 0000 19 58 61	0 ... 25	50	4 ... 20 mA	± 0.4
FPT40.0A	8235 81 2391 05 0000 0000 19 58 61	0 ... 40	80	4 ... 20 mA	± 0.4
FPT100.0A	8235 83 2391 05 0000 0000 19 58 61	0 ... 100	200	4 ... 20 mA	± 0.4

Dimensions

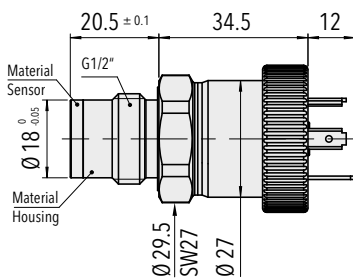

8235.XX.XX91.05.XX.XX

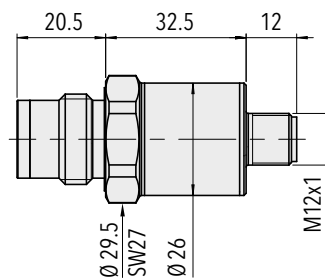

8235.XX.XX91.35.XX.XX

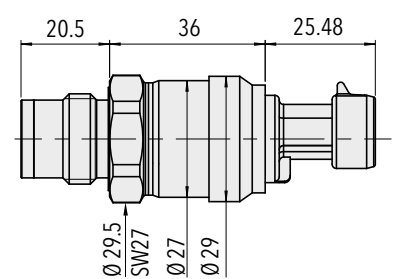

8235.XX.XX91.51.XX.XX

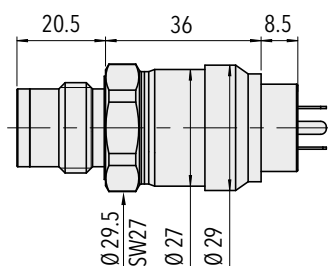

8235.XX.XX91.01.XX.XX

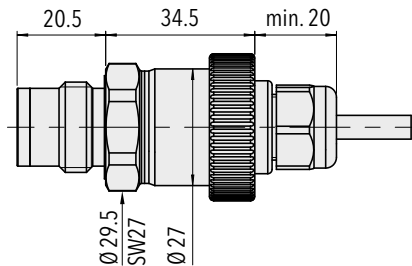

8235.XX.XX91.22.XX.XX

8235.XX.XX91.68.XX.XX

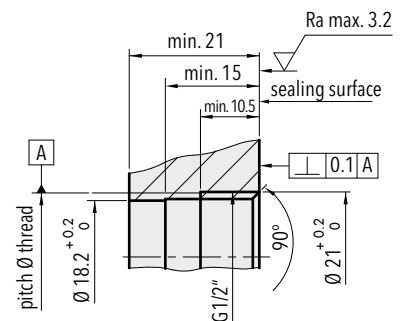

Mounting thread G1/2"
DIN EN ISO 1179-1

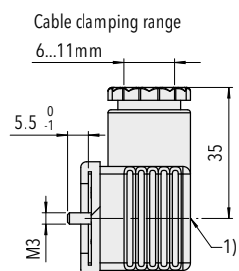

1) Torque moment 50...60 Ncm

8235.XX.XXXX.XX.XX.58

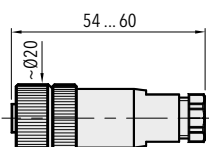

8235.XX.XXXX.XX.XX.33

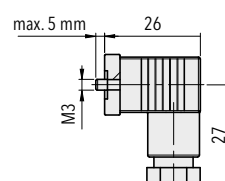

8235.XX.XXXX.XX.XX.34

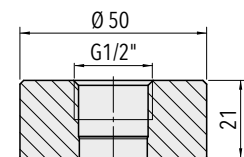

Welding flange for G1/2"
(1.4301)
Ordering No. C27804

Specifications		
Accuracy	TEB typ. @ -25 ... +85°C	± 0.5 % FS typ.
	Accuracy @ 25°C typ.	± 0.4 % FS
	NLH @ 25°C (BSL) typ.	± 0.1 % FS typ.
	TC zero point and span typ.	± 0.005 % FS/K typ.
	Long term stability 1 year typ.	± 0.2 % FS typ.
Electrical Data	Output / supply voltage	4 ... 20 mA: 24 (9 ... 30) VDC 0 ... 5 VDC: 24 (10 ... 30) VDC 1 ... 6 VDC: 24 (10 ... 30) VDC 0 ... 10 VDC: 24 (15 ... 30) VDC 0.5 ... 4.5 VDC: 5 VDC ratiom.
	Rise time	Typ. 1 ms / 10 ... 90 % nominal pressure
	Switch-on-delay	max. 1.5 s
Environmental conditions	Media temperature	-40°C ... +125°C
	Ambient temperature	-40°C ... +85°C (Cable PVC 22: -5°C ... +60°C)
	Protection ¹⁾	IP65, IP67, IP68
	Humidity	Max. 95 % relative
	Vibration	15 g (50...2000 Hz)
	Shock	50 g / 3 ms
EMC Protection	Emission	EN/IEC 61000-6-3
	Immunity	EN/IEC 61000-6-2
Mechanical Data	Sensor (wetted parts)	1.4542 (AISI630)
	Pressure connection (wetted parts)	1.4542 (AISI630)
	Housing	1.4301 (AISI304)
	Sealing	FPM (FKM) NBR
	Weight	~ 80 ... 110 g (without cable)
	Mounting torque	20 ... 25 Nm not lubricated
		15 ... 20 Nm lubricated

¹⁾ See electrical connection

Measuring accuracy

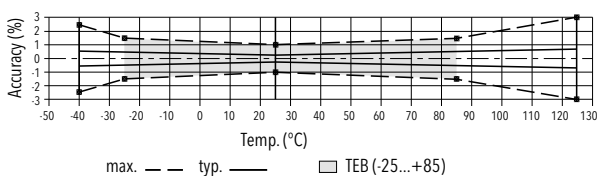

Electrical connection

		Protection / electrical connection									
		IP65*)		IP67/IP68 max. 3m		IP67*)		IP67*)		IP65	
		Industrial standard EN175301-803A 05		Cable **) 22/68		M12x1 5-pole 35		Packet Metri Pak 3-pole 51		Industrial standard EN175301-803A 01	
Output signal	<p>shield</p> <p>⊕ U_S (pos. Supply)</p> <p>⊖ U_S (neg. Supply)</p> <p>⊕ earth/housing</p> <p>4-20mA</p> <p>8235.XX.XXXX.XX.19</p>	Standard	92			Standard	94			99	
		2	1	white		4	1	1	1	2	
		1	2	brown		1	3	2	3	1	
		⊕	⊖	⊖		5	5			⊖	
	<p>shield</p> <p>supply ⊕</p> <p>output ⊖</p> <p>common ⊖</p> <p>for DC</p> <p>8235.XX.XXXX.XX.14/16/17/23</p>	Standard	98	97					99		
		2	3	1	white		2	1	1	1	1
		3	1	3	green		4	3	2	2	2
		1	2	2	brown		3	2	3	3	3
		⊖	⊕	⊖	⊖		5			⊖	⊖

*) Electrical connections 05/35/51: provided female connector is mounted according to instructions

**) Ventilation via cable end; shield in the device is not connected

Additional information

Documents

Data sheet	www.trafag.com/H72316
Instructions	www.trafag.com/H73316
Flyer	www.trafag.com/H70648

CANOPEN MINIATURE PRESSURE TRANSMITTER

Swiss based Trafag is a leading international supplier of high quality sensors and monitoring instruments for measurement of pressure and temperature. The CANopen miniature pressure transmitter CMP is based on Trafag's own thin-film-on-steel technology which offers high accuracy and longterm stability even in harsh environments. The most compact design and the proven high-performance electronics with CiA-certified, comprehensive CANopen-functionality makes the CMP 8270 best-in-class pressure transmitter.



Applications

- Engine manufacturing
- Railways
- Machine tools
- Hydraulics
- Process technology
- Test benches

Features

- Small and rugged construction
- Different accuracy classes
- Measurement of pressure and temperature
- CANopen bus protocol DS301/DS404 supports CAN 2.0A/B
- LSS (DS 305 V2.0)

Technical Data			
Measuring principle	Thin film on steel	Accuracy @ 25°C typ.	± 0.5 % FS typ. ± 0.15 % FS typ. ± 0.1 % FS typ.
Measuring range	0 ... 0.2 to 0 ... 600 bar	Media temperature	-50°C ... +135°C
Output signal	Bus protocol CANopen DS404	Ambient temperature	-40°C ... +125°C

Subject to change

Ordering information/type code

				8270 . XX	XX	XX	XX	XX	XX
Measuring range ¹⁾	Pressure measurement range [bar]	Over pressure [bar]	Burst pressure [bar]						
		0 ... 0.2 ^{2) 3) 5)}	1.2	25	68				
	0 ... 0.4 ^{2) 5)}	1.2	25	69					
	0 ... 0.6 ^{2) 5)}	1.5	25	70					
	0 ... 1 ²⁾	2	25	71					
	0 ... 1.6 ²⁾	3.5	50	73					
	0 ... 2.5 ²⁾	5	50	75					
	0 ... 4	12	100	76					
	0 ... 6	12	100	77					
	0 ... 10	20	200	78					
	0 ... 16	32	200	79					
	0 ... 25	50	300	80					
	0 ... 40	80	300	81					
	0 ... 60	120	400	82					
	0 ... 100	200	500	83					
	0 ... 160	320	750	85					
	0 ... 250	500	1000	74					
	0 ... 400	800	1500	84					
	0 ... 600	1200	2000	86					
Sensor	Relative pressure, accuracy: 0.5 %	25	Absolute pressure, accuracy: 0.5 % ⁴⁾	45					
	Relative pressure, accuracy: 0.15 %	21	Absolute pressure, accuracy: 0.15 % ⁴⁾	41					
	Relative pressure, accuracy: 0.1 %	24	Absolute pressure, accuracy: 0.1 % ⁴⁾	44					
Pressure connection	G1/4" male (Seal)							17	
	1/4" NPT male							30	
	7/16"-20UNF male ^{3) 4)}							18	
	7/16"-20UNF female, DIN3866 (valve opener) ^{3) 4)}							24	
Electrical connection	Male electrical plug M12x1, 5-pole, Mat. PA							35	
Output signal	CANopen bus protocol with pre-adjustment Node-ID = 1, baudrate = 20 kbps								52
	CANopen bus protocol with pre-adjustment, Node-ID: 1, automatic baudrate detection								53
Accessories	Female electrical plug M12x1, 5-pole								33
	Pressure peak damping element ø 1.0 mm								40
	Pressure peak damping element ø 0.3 mm								43
	Pressure peak damping element ø 0.5 mm								45

¹⁾ Extended overpressure as well as customized pressure ranges upon request

²⁾ Only with pressure connection 17 (G1/4") or 30 (1/4"NPT)

³⁾ Only for relative pressure

⁴⁾ Max. allowable pressure range 40 bar

⁵⁾ Only for sensors 0.5 % accuracy (Ordering no. 25 and 45)

Standard products (extra short lead time)

Product No.	Type Code	Pressure range [bar]	Over pressure max. [bar]	Supply [VDC]	Accuracy @ 25°C typ. [%]
CMP4.0M	8270 76 2517 35 0000 0000 52 43	0 ... 4	12	8 ... 32	± 0.5
CMP6.0M	8270 77 2517 35 0000 0000 52 43	0 ... 6	12	8 ... 32	± 0.5
CMP10.0M	8270 78 2517 35 0000 0000 52 43	0 ... 10	20	8 ... 32	± 0.5
CMP16.0M	8270 79 2517 35 0000 0000 52 43	0 ... 16	32	8 ... 32	± 0.5
CMP25.0M	8270 80 2517 35 0000 0000 52 43	0 ... 25	50	8 ... 32	± 0.5
CMP40.0M	8270 81 2517 35 0000 0000 52 43	0 ... 40	80	8 ... 32	± 0.5
CMP100.0M	8270 83 2517 35 0000 0000 52 43	0 ... 100	200	8 ... 32	± 0.5
CMP250.0M	8270 74 2517 35 0000 0000 52 43	0 ... 250	500	8 ... 32	± 0.5
CMP400.0M	8270 84 2517 35 0000 0000 52 43	0 ... 400	800	8 ... 32	± 0.5

Dimensions

≤ 0 ... 2.5 bar

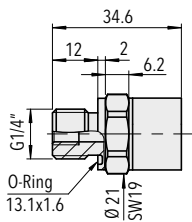

8270.XX.XX17.XX.XX.XX

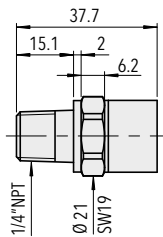

8270.XX.XX30.XX.XX.XX

> 0 ... 2.5 bar

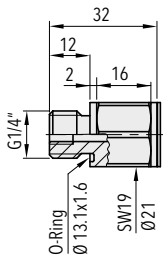

8270.XX.XX17.XX.XX.XX

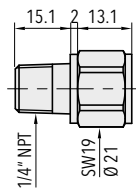

8270.XX.XX30.XX.XX.XX

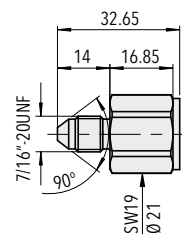

8270.XX.XX18.XX.XX.XX

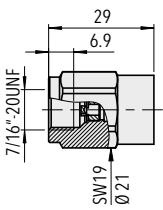

8270.XX.XX24.XX.XX.XX

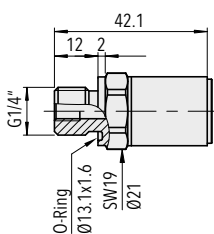

8270.XX.4417.XX.XX.XX

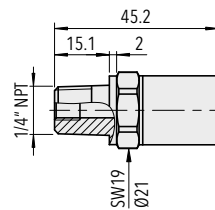

8270.XX.4430.XX.XX.XX

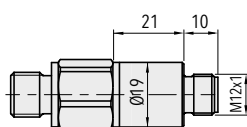

8270.XX.XXXX.35.XX.XX

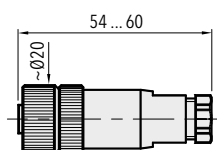
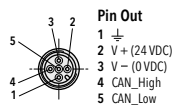

8270.XX.XXXX.XX.XX.33

Specifications		
Electrical Data	Output / supply voltage	Bus protocol CANopen / 12/24 (8...32)VDC
	Rise time	Typ. 1 ms / 10 ... 90 % nominal pressure
	Current consumption	ca. 20 mA
Environmental conditions	Media temperature	-50°C ... +135°C
	Ambient temperature	-40°C ... +125°C
	Protection ¹⁾	Min. IP67
	Humidity	Max. 95 % relative
	Vibration	40 g (20 ... 2000 Hz)
	Shock	100 g / 11 ms
EMC Protection	Emission	EN/IEC 61000-6-4
	Immunity	EN/IEC 61000-6-2
Mechanical Data	Sensor (wetted parts)	1.4542 (AISI630)
	Pressure connection (wetted parts)	Pressure ranges ≤ 250 bar: 1.4542 (AISI630) Pressure ranges > 250 bar: 1.4301 (AISI304)
	Housing	1.4301 (AISI304)
	Sealing	FKM 70 Sh
	Male electrical plug	See ordering information
	Weight	~ 60 g
	Mounting torque	25 Nm

¹⁾ Provided female connector is mounted according to instructions

Accuracy				
		Measuring accuracy 0.5 % Ordering No. 25/45	Measuring accuracy 0.15 % Ordering No. 21/41	Measuring accuracy 0.1 % Ordering No. 24/44
TEB @ -25 ... +85°C	[% FS typ.]	± 2.0	± 0.2	± 0.1
Accuracy @ +25°C	[% FS typ.]	± 0.5	± 0.15	± 0.1
NLH @ +25°C (BSL)	[% FS typ.]	± 0.3	± 0.15	± 0.1
TC zero point and span	[% FS/K typ.]	± 0.03	± 0.002	± 0.002
Long term stability 1 year @ +25°C	[% FS typ.]	< ± 0.2	± 0.1	< ± 0.1
Signal of pressure sensor				
Resolution		11 bit @ 1 ms 13 bit @ ≥ 5 ms	11 bit @ 1 ms 13 bit @ ≥ 5 ms	11 bit @ 1 ms 13 bit @ ≥ 5 ms
Sampling rate (fix)		1ms (1 kHz)	1ms (1 kHz)	1ms (1 kHz)
Measuring filter (moving average)	[ms]	1 ... 65'000	1 ... 65'000	1 ... 65'000
Signal of temperature sensor				
Total error @ -25 ... +85°C	[°C typ.]	not calibrated	± 1	± 1
Sampling rate (fix)			10x100 ms (1 Hz)	10x100 ms (1 Hz)
Measuring filter (moving average)	[s]		0.1 ... 6500	0.1 ... 6500

CANopen Features

- CiA conformance tested
- All CiA bus speeds: 10kbit/s...1Mbit/s
- Autobaud
- Supports 11/29 bit identifiers: CAN 2.0 A/B
- Frequency of measurement and transmission upto 1kHz
- Moving average filter: 1ms...65s (pressure)
- Additional PDO mode: delta and limit triggered
- All standardised data types for PDO's Floating point, integer with 32, 24, 16 bits
- Eligible, prefix adjustable units pressure: bar, Pa, psi, mmHg, mmWg, atm, at; temperature: °C, °F, K
- Auto-zero function
- Auto-Start-Mode for operation without master
- 4 Pressure - and 4 temperature thresholds with 8 free definable CAN messages
- Separate storage of parameters for communication and application
- Flash-Update
- Baudrate detection

CANopen- Bus Protocol

- Output signal: CAN BUS (ISO 118982)
- CANopen: DS301 V4.0
- Device profile: DS404 V1.2
- Baudrate (Autobaude): 10kbit/s...1Mbit/s
- Error control: Nodeguarding, Heartbeat
- Node ID: LSS (DSP 305 V2.0) fully implemented, proprietary
- No. of PDO's: 4 TX
- PDO modes: event-/time-triggered, remotely requested, sync (cyclic/acyclic)
- PDO linking: yes
- PDO mapping: yes
- No. of SDO's: 1 server
- Emergency message: yes

Additional information

Documents		
	Data sheet	www.trafag.com/H72614
	Instructions	www.trafag.com/H73614
	Flyer	www.trafag.com/H70653

NAVITRAG

Swiss based Trafag is a leading international supplier of high quality sensors and monitoring instruments for measurement of pressure and temperature.



Applications

- Shipbuilding
- Engine manufacturing



Features



- Excellent long-term stability
- Protection IP65
- EMC protection, IEC 61000
- Excellent resistance to pressure peaks and dynamic pressure changes

Technical Data

Measuring principle	Thin film on steel	Media temperature	-25°C ... +125°C
Measuring range	0 ... 1.0 to 0 ... 600 bar	Ambient temperature	-25°C ... +85°C
Output signal	4 ... 20 mA	Approval / conformity	ABS, BV, CCS, DNV-GL, KRS, LRS, RINA
Accuracy @ 25°C typ.	± 0.5 % FS typ.		

Subject to change

Ordering information/type code

				8202 .	XX	XX	XX	XX	XX
Measuring range ¹⁾	Pressure measurement range	Over pressure	Burst pressure						
	[bar]	[bar]	[bar]						
	0 ... 1.0	3	100	71					
	0 ... 1,6	3	100	73					
	0 ... 2.5	6	100	75					
	0 ... 4	10	100	76					
	0 ... 6	15	100	77					
	0 ... 10	20	200	78					
	0 ... 16	32	200	79					
	0 ... 25	80	300	80					
	0 ... 40	80	300	81					
	0 ... 60	200	500	82					
	0 ... 100	200	500	83					
	0 ... 160	500	1000	85					
	0 ... 250	500	1000	74					
	0 ... 400	800	1500	84					
	0 ... 600	1000	2000	86					
Sensor	relative								22
	absolute								26
Pressure connection	G1/4" female								10
	G1/2" male								11
Fixing	Wall mounting bracket								31
Accessories	 Connector with marine cable gland DIN89280, M24x1.5 (Cable-ø 14...16.5)								27
	 Connector with marine cable gland DIN89280, M18x1.5 (Cable-ø 8...10.5)								40
	Cable gland for screened cable, Cable ø 6...12mm								28
	Damping elements and Snubber: See specification sheet H72258								

¹⁾ Customized pressure ranges upon request

Standard products (extra short lead time)

Product No.	Type Code	Pressure range [bar]	Over pressure max. [bar]	Supply [VDC]	Accuracy @ 25°C typ. [%]
N1.0	8202 71 2210	0...1	3	12...34	± 0.5
N2.5	8202 75 2210	0...2.5	6	12...34	± 0.5
N4.0	8202 76 2210	0...4	10	12...34	± 0.5
N6.0	8202 77 2210	0...6	15	12...34	± 0.5
N10.0	8202 78 2210	0...10	20	12...34	± 0.5
N16.0	8202 79 2210	0...16	32	12...34	± 0.5
N25.0	8202 80 2210	0...25	80	12...34	± 0.5
N40.0	8202 81 2210	0...40	80	12...34	± 0.5
N100.0	8202 83 2210	0...100	200	12...34	± 0.5
N250.0	8202 74 2210	0...250	500	12...34	± 0.5
N400.0	8202 84 2210	0...400	800	12...34	± 0.5

Specifications		
Accuracy	TEB typ. @ -25 ... +85°C	± 2 % FS typ.
	Accuracy @ 25°C typ.	± 0.5 % FS typ.
	NLH @ 25°C (BSL) typ.	± 0.3 % FS typ.
	TC zero point and span typ.	± 0.02 % FS/K typ.
	Long term stability 1 year typ.	± 0.2 % FS typ.
Electrical Data	Output / supply voltage	4 ... 20 mA; 24 (12 ... 34) VDC
	Load	$U_{\text{supply}} - 12\text{V} / 20 \text{ mA}$
	Rise time	typ. 1 ms/10...90 % nominal pressure
Environmental conditions	Media temperature	-25°C ... +125°C
	Ambient temperature	-25°C ... +85°C
	Protection	Min. IP65
	Humidity	Max. 95 % relative
	Vibration	6g (25...2000 Hz)
	Shock	50g/ 11 ms
EMC Protection	Emission	EN/IEC 61000-6-3
	Immunity	EN/IEC 61000-6-2
Mechanical Data	Electrical connections	Terminal screw 0.75 ... 2.5 mm ²
	Screwed cable gland	M20x1.5 Cable-Ø 6...13 mm
	Sensor (wetted parts)	1.4542 (AISI630)
	Pressure connection (wetted parts)	1.4542 (AISI630)
	Housing	AlSi10Mg/ Epoxy coated
	Sealing	NBR 70 Sh
	Weight	~ 520 g
	Mounting torque	25 Nm

Electrical Connection

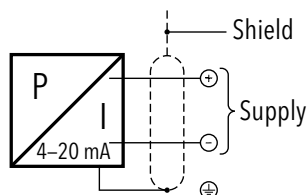

Additional information		
Documents	Data sheet	www.trafag.com/H72206
	Instructions	www.trafag.com/H70722
	Flyer	www.trafag.com/H70677

Dimensions

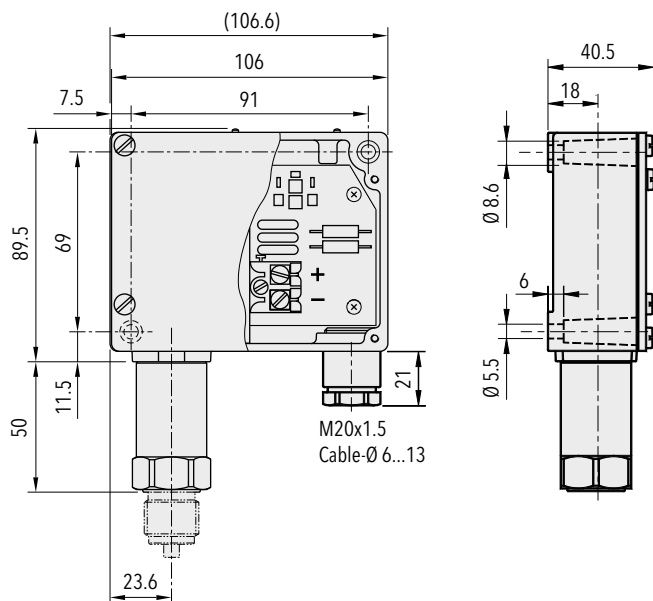

8202.XX.XXXX.XX.XX

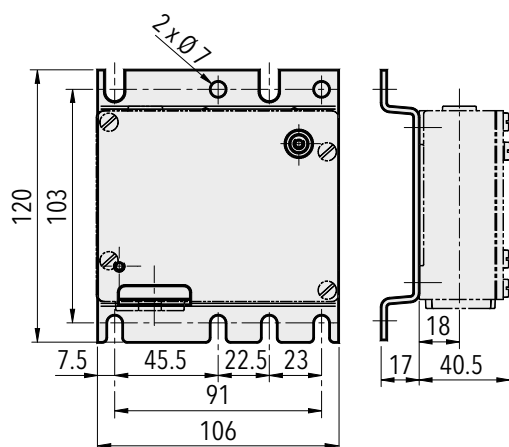

8202.XX.XXXX.31.XX

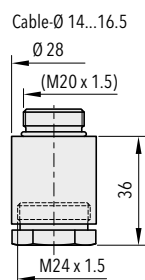

8202.XX.XXXX.XX.27

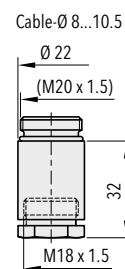

8202.XX.XXXX.XX.40

DIFFERENTIAL PRESSURE TRANSMITTER

Swiss based Trafag is a leading international supplier of high quality sensors and monitoring instruments for measurement of pressure and temperature.



Applications

- Shipbuilding
- Engine manufacturing

Features



- High zero point stability
- High resistance to pressure cycling
- EMC protection, IEC 61000

Technical Data

Measuring principle	Thin film on steel	Media temperature	-25°C ... +125°C
Measuring range	0 ... 1 to 0 ... 16 bar	Ambient temperature	-25°C ... +85°C
Output signal	4 ... 20 mA (P1-P2)	Approval / conformity	BV, DNV, RINA
Accuracy @ 25°C typ.	± 0.8 % FS typ		

Subject to change

Ordering information/type code

				8204 . XX	XXXX	XX	XX
Measuring range ¹⁾	Pressure measurement range [bar]	Maximum system pressure [bar]	Overpressure on one side [bar]				
	0 ... 1.0	2.5	6	71			
	-1 ... 1.5	6	15	55			
	0 ... 2.5	6	15	75			
	-1 ... 5	16	32	58			
	0 ... 6	16	32	77			
	0 ... 10	40	80	78			
	0 ... 16	40	80	79			
Pressure connection	G1/4" female			2210			
Fixing	Fixing Standard						00
	Wall mounting bracket						31
Accessories	 Connector with marine cable gland DIN89280, M24x1.5 (Cable-ø 14...16.5)						27
	 Connector with marine cable gland DIN89280, M18x1.5 (Cable-ø 8...10.5)						40
	Damping elements and Snubber: See specification sheet H72258						

¹⁾ Customized pressure ranges upon request

Standard products (extra short lead time)

Product No.	Type Code	Differential pressure (measuring range) [bar]	Maximum system pressure [bar]	Over pressure max. [bar]	Supply [VDC]	Accuracy @ 25°C typ. [%]
ND1.0	8204 71 2210	0 ... 1.0	2.5	6	12 ... 34	± 0.8
ND1.5	8204 55 2210	-1 ... 1.5	6	15	12 ... 34	± 0.8
ND2.5	8204 75 2210	0 ... 2.5	6	15	12 ... 34	± 0.8
ND5	8204 58 2210	-1 ... 5.0	16	32	12 ... 34	± 0.8
ND6	8204 77 2210	0 ... 6.0	16	32	12 ... 34	± 0.8

Specifications		
Accuracy	TEB typ. @ -25 ... +85°C	± 3.5 % FS typ.
	Accuracy @ 25°C typ.	± 0.8 % FS typ.
	NLH @ 25°C (BSL) typ.	± 0.5 % FS typ.
	TC zero point and span typ.	± 0.04 % FS/K typ.
	Long term stability 1 year typ.	± 0.4 % FS typ.
Electrical Data	Output / supply voltage	4 ... 20 mA; 24 (12 ... 34) VDC
	Load	$U_{\text{supply}} - 12\text{V}/20\text{ mA}$
	Rise time	typ. 1 ms/10...90 % nominal pressure
Environmental conditions	Media temperature	-25°C ... +125°C
	Ambient temperature	-25°C ... +85°C
	Protection ¹⁾	Min. IP65
	Humidity	Max. 95 % relative
	Vibration	6g (25...2000 Hz)
	Shock	50g/ 1 ms
EMC Protection	Emission	EN/IEC 61000-6-3
	Immunity	EN/IEC 61000-6-2
Mechanical Data	Electrical connections	Terminal screw 0.75 ... 2.5 mm ²
	Screwed cable gland	M20x1.5 Cable-Ø 6...13 mm
	Sensor (wetted parts)	1.4542 (AISI630)
	Pressure connection (wetted parts)	1.4542 (AISI630)
	Housing	AlSi10Mg/ Epoxy coated
	Sealing	NBR 70 Sh
	Weight	~ 720 g
	Mounting torque	25 Nm

¹⁾ Provided female connector is mounted according to instructions

Electrical Connection

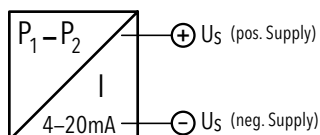

Functional diagram

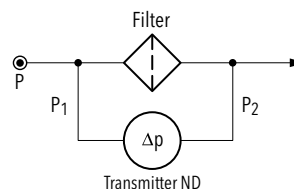

Δp = Differential Pressure
 P_1 = Higher pressure
 P_2 = Lower pressure
 P = System pressure

EX PRESSURE TRANSMITTER

Swiss based Trafag is a leading international supplier of high quality sensors and monitoring instruments for measurement of pressure and temperature. The EX pressure transmitter EXNT is based on Trafag's own thin-film-on-steel sensor technology with excellent long-term stability and offers reliable and accurate pressure measurement over a wide temperature range. The intrinsic safety design is certified for applications in Ex-Zones 0, 1, 2 (gas), 20, 21, 22 (dust) and mining.



Applications

- Shipbuilding
- Ex Zones 0, 1, 2 (gas); 20, 21, 22 (dust) and mining
- Hydrogen

Features

- - II 1G Ex ia IIC T4/T6 Ga
 - II 1D Ex ia IIIC T130° Da
 - I M1 Ex ia I Ma
 - II 1/2G Ex ia IIC T4/T6 Ga/Gb (with plastic-type connector)
- Pressure ranges from 0.4 to 2000 bar
- Completely welded sensor system
- Optional with hydrogen-compatible sensor
- ATEX and IECEx

Technical Data

Measuring principle	Thin film on steel	Media temperature	Max. -40°C ... +120°C (see electrical connection)
Measuring range	0 ... 0.4 to 0 ... 2000 bar 0 ... 5 to 0 ... 30000 psi	Ambient temperature	Max. -40°C ... +120°C (see electrical connection)
Output signal	4 ... 20 mA	Approval / conformity	GL, KRS ATEX / IECEx, according to the norm EN/IEC 60079-0/EN 60079-11/ EN 60079-26/ EN 50303
Accuracy @ 25°C typ.	± 0.5 % FS typ. ± 0.3 % FS typ.		

Subject to change

Ordering information/type code

				8292 . XX	XX	XX	XX	XX	XX	
Measuring range ¹⁾	Pressure measurement range [bar]	Over pressure [bar]	Burst pressure [bar]	Pressure measurement range [psi]	Over pressure [psi]	Burst pressure [psi]				
	0 ... 0.4 ²⁾	1.2	25	0 ... 5 ²⁾	18	350	F9			
	0 ... 0.6 ²⁾	1.5	25	0 ... 10 ²⁾	25	350	G0			
	0 ... 1.0 ²⁾	2.0	25	0 ... 15 ²⁾	30	350	G1			
	0 ... 1.6	3.5	80	0 ... 25	50	1200	G3			
	0 ... 2.5	5	100	0 ... 30	30	720	G5			
	0 ... 4	8	100	0 ... 50	120	860	G6			
	0 ... 6	12	100	0 ... 100	170	1450	G7			
	0 ... 10	20	200	0 ... 150	290	2900	G8			
	0 ... 16	32	200	0 ... 250	460	2900	G9			
	0 ... 25	50	300	0 ... 400	730	4350	H0			
	0 ... 40	80	300	0 ... 500	1160	4350	H1			
	0 ... 60	120	500	0 ... 1000	1740	5800	H2			
	0 ... 100	200	500	0 ... 1500	2900	7250	H3			
	0 ... 160	320	1000	0 ... 2000	4640	10850	H5			
	0 ... 250	500	1000	0 ... 3000	7250	14500	G4			
	0 ... 400	800	1500	0 ... 5000	11600	21750	H4			
	0 ... 600	1000	2000	0 ... 7500	14500	29000	H6			
	0 ... 1000 ⁹⁾	1600	3000	0 ... 15000 ⁹⁾	25000	45000	H8			
	0 ... 1600	3000	4000	0 ... 25000	45000	60000	H9			
0 ... 2000	3000	4000	0 ... 30000	45000	60000	J0				
Sensor	Relative pressure, accuracy: 0.3% (> 1 bar)						23			
	Relative pressure, accuracy: 0.5% (> 1 bar)						25			
	Relative pressure, accuracy: 0.5% (≤ 1 bar)						26			
	Relative pressure, accuracy: 0.5 %, wetted parts hydrogen compatible ^{7) 8)}						35			
	Relative pressure, accuracy: 0.3 %, wetted parts hydrogen compatible ^{7) 8)}						33			
Pressure connection	G1/4" male ³⁾						17			
	G1/4" male (Manometer) EN 871 ^{3) 8)}						53			
	G1/4" female ^{3) 8)}						10			
	G1/2" male ^{3) 8)}						21			
	G1/2" male (Manometer) ^{3) 8)}						11			
	R1/4" male ^{3) 8)}						19			
	1/4" NPT male ^{3) 8)}						30			
	M18x1.5 male (conical seal: 58°) ^{4) 8)}						29			
Electrical connection	Male electrical plug EN 175301-803-A, plastic (only zones 1, 2 (gas) and 20, 21 (dust))						05			
	Male electrical plug M12x1, 5-pole, metal						35			
	Male electrical plug MIL-C 26482, 6-pole, metal ⁵⁾						02			
	Male electrical plug Binder 723, 5-pole, metal						14			
	Cable with shield, material FDR 25 (Raychem), 4 x 0.5mm ² (cable length see "Accessories") - not ship approved						78			
	Cable intrinsically safe with shield, material PVC, 2 x 0.75mm ² (-40...+80°C), (cable length see "Accessories") - not ship approved						80			
Output signal	Signal output	Load resistance	I (supply)	U (supply)						
	4 ... 20 mA	(Usupply-10 V) / 20 mA		10 ... 30 VDC	19					

Accessories	Female electrical connector EN 175301-803-A (DIN43650-A), plastic (only zones 1, 2 (gas) and 20, 21 (dust))	58
	Female electrical plug M12x1, 5-pole, plastic (only zones 1, 2 (gas) and 20, 21 (dust))	33
	Female electrical plug M12x1, 5-pole, metal	35
	Female electrical connector MIL-C 26482, 6-pole, metal	32
	Female electrical connector Binder 723, 5-pole, metal	37
	Pressure peak damping element ø 0.4 mm	44
	Pressure peak damping element ø 1.0 mm	40
	Cable length 1.5 m ⁶⁾	1M
	Cable length 3.0 m ⁶⁾	3M
	Cable length 5.0 m ⁶⁾	5M
	Special electrical connection: Pin 1 +, Pin 2 - (only for output signal 4 ... 20 mA and male electrical plug EN175301-803-A / DIN43650-A)	92
	Zener barrier 28V/93mA; R ≈300Ω; Ordering no ZEN28VDC	
	Damping elements and snubber see data sheet H72258	

¹⁾ Extended overpressure as well as customized pressure ranges upon request

²⁾ Only with sensor 26 (0.5%)

³⁾ For pressure ranges ≤ 600 bar

⁴⁾ For pressure ranges > 600 bar

⁵⁾ For pressure ranges < 40 bar upon request

⁶⁾ Other cable lengths upon request

⁷⁾ Pressure ranges 0 ... 40 to 0 ... 1000 bar

⁸⁾ Upon request

⁹⁾ With sensors 33 and 35: Overpressure 1300 bar/19000 psi, Burst pressure 2600 bar/38000 psi

Standard products (extra short lead time)

Product No.	Type Code	Pressure range [bar]	Over pressure max. [bar]	Supply [VDC]	Accuracy @ 25°C typ. [%]
EXNT0.4A	8292 69 2617 05 0000 0000 19 58 92	0 ... 0.4	1.2	10 ... 30	± 0.5
EXNT0.6A	8292 70 2617 05 0000 0000 19 58 92	0 ... 0.6	1.5	10 ... 30	± 0.5
EXNT1.0A	8292 71 2617 05 0000 0000 19 58 92	0 ... 1	2	10 ... 30	± 0.5
EXNT2.5A	8292 75 2517 05 0000 0000 19 58 92	0 ... 2.5	5	10 ... 30	± 0.5
EXNT4.0A	8292 76 2517 05 0000 0000 19 58 92	0 ... 4	8	10 ... 30	± 0.5
EXNT6.0A	8292 77 2517 05 0000 0000 19 58 92	0 ... 6	12	10 ... 30	± 0.5
EXNT10.0A	8292 78 2517 05 0000 0000 19 58 92	0 ... 10	20	10 ... 30	± 0.5
EXNT16.0A	8292 79 2517 05 0000 0000 19 58 92	0 ... 16	32	10 ... 30	± 0.5
EXNT25.0A	8292 80 2517 05 0000 0000 19 58 92	0 ... 25	50	10 ... 30	± 0.5
EXNT40.0A	8292 81 2517 05 0000 0000 19 58 92	0 ... 40	80	10 ... 30	± 0.5
EXNT100.0A	8292 83 2517 05 0000 0000 19 58 92	0 ... 100	200	10 ... 30	± 0.5
EXNT250.0A	8292 74 2517 05 0000 0000 19 58 92	0 ... 250	500	10 ... 30	± 0.5

Specifications		
Electrical Data	Output / supply voltage	4 ... 20 mA; 24 (10 ... 30) VDC
	Rise time	Typ. 1 ms / 10 ... 90 % nominal pressure
	Switch-on-delay	Max. 1.5 s
Environmental conditions	Media temperature	Max. -40°C ... +120°C (see electrical connection)
	Ambient temperature	Max. -40°C ... +120°C (see electrical connection)
	Protection ¹⁾	Min. IP65 Electrical connection cable: IP67 Electrical connection 02: IP67
	Humidity	Max. 95 % relative
	Vibration	10 g (50...2000 Hz)
	Shock	50 g / 3 ms
EMC Protection	Emission	IEC 61000-6-4
	Immunity	IEC 61000-6-2
Mechanical Data	Sensor (wetted parts)	1.4542 (AISI630), optional hydrogen-compatible steel
	Pressure connection (wetted parts)	Pressure ranges ≤ 250 bar and > 600 bar: 1.4542 (AISI630) Pressure ranges > 250 bar and ≤ 600 bar: 1.4301 (AISI304) Optional hydrogen-compatible steel
	Housing	1.4301 (AISI304)
	Sealing	FKM 70 Sh
	Male electrical plug	See ordering information
	Weight	~ 165 g
	Mounting torque	25 Nm Pressure connection 29: 30 Nm

¹⁾ See electrical connection

Accuracy				
		Class 0.5 % Ordering No. 25 (> 1 bar)	Class 0.3 % Ordering No. 23 (> 1 bar)	Class 0.5 % Ordering No. 26 (≤ 1 bar)
TEB @ -25...+85°C	[% FS typ.]	± 2.0	± 0.5	± 1.0
Accuracy @ +25°C	[% FS typ.]	± 0.5	± 0.3	± 0.5
NLH @ +25°C (BSL)	[% FS typ.]	± 0.2	± 0.1	± 0.10
TC zero point and span	[% FS/K typ.]	± 0.03	± 0.005	± 0.01
Long term stability 1 year @ +25°C	[% FS typ.]	± 0.2	± 0.2	± 0.2
Mounting dependency with 180° rotation (Vibration and shock: multiply this value with number of g)	[% FS typ.]	-	-	0 ... 1 bar: 0.05 0 ... 0.6 bar: 0.09 0 ... 0.4 bar: 0.13

Class 0.5 %

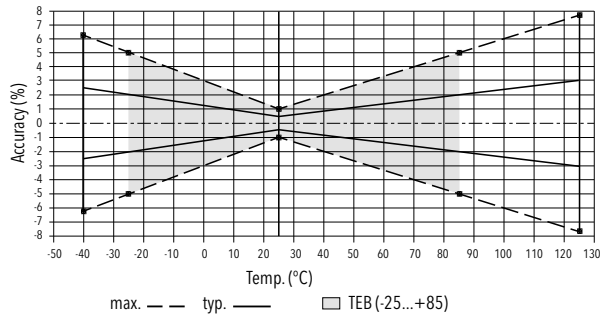

Class 0.3 %

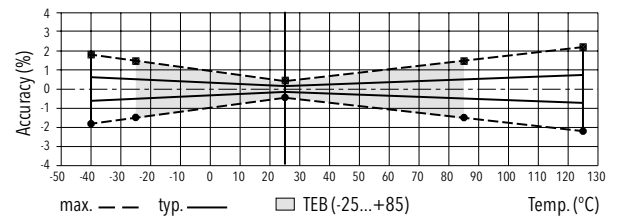

Electrical connection

		Protection / electrical connection						
		IP65*)	IP67	IP67	IP65*)	IP67*)	IP65*)	
		Industrial standard EN175301-803A	Cable **) (4 x 0.5 mm ²)	Cable **) (2 x 0.75 mm ²)	Binder 723	MIL-C 26482	M12x1 5-pole	
		05	78 Shield	80 Shield	14	02	35	
Output signal		Standard 2 1 ⊖	92 1 2 ⊖	brown black yellow / green (blue = not connected)	1 (black) 2 (black) -	3 1 5	A C F	4 1 5
	8292 .XX.XXXX.XX.19							
T-Range	Ambient and media temperature T4	-40 ... +120°C	-40 ... +120°C	-40 ... +80°C	-30 ... +95°C	-40 ... +120°C	-40 ... +120°C	
	Ambient and media temperature T6	-40 ... +65°C	-40 ... +65°C	-40 ... +65°C	-30 ... +65°C	-40 ... +65°C	-40 ... +65°C	

*) Provided female connector is mounted according to instructions

**) Ventilation via cable end

***) Only cable versions or female electrical plug with shield connection

Additional information

Documents

Data sheet	www.trafag.com/H72329
Instructions	www.trafag.com/H73329
Flyer	www.trafag.com/H70657

Dimensions

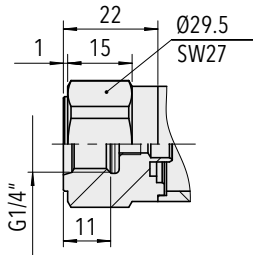

8292.XX.XX10.XX.XX.XX
(≤ 600 bar)

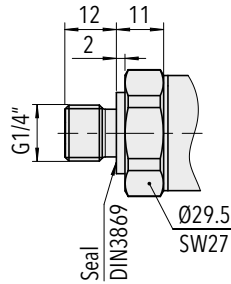

8292.XX.XX17.XX.XX.XX
(≤ 600 bar)

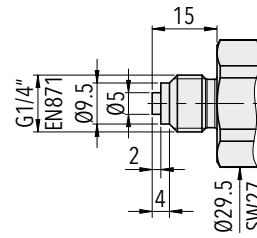

8292.XX.XX53.XX.XX.XX

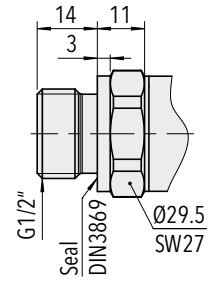

8292.XX.XX21.XX.XX.XX
(≤ 600 bar)

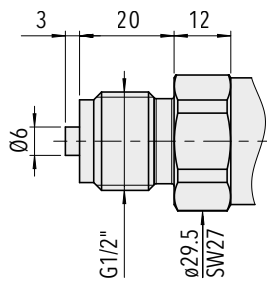

8292.XX.XX11.XX.XX.XX
(≤ 600 bar)

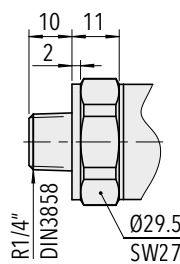

8292.XX.XX19.XX.XX.XX
(≤ 600 bar)

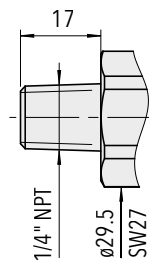

8292.XX.XX30.XX.XX.XX
(≤ 600 bar)

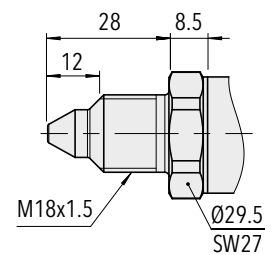

8292.XX.XX29.XX.XX.XX
(> 600 bar)

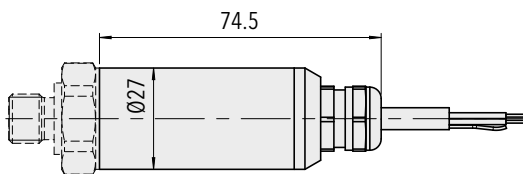

8292.XX.XXXX.78/80.XX.XX

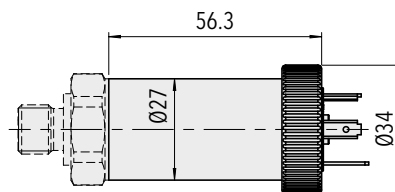

8292.XX.XXXX.05.XX.XX

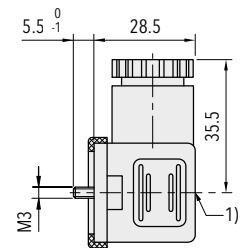

1) Tightening to torque 50...60Nm

8292.XX.XXXX.XX.XX.58

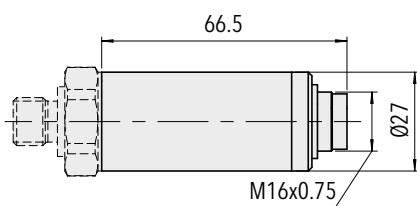

8292.XX.XXXX.14.XX.37

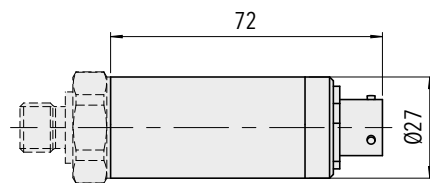
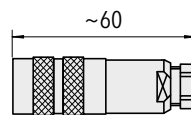

8292.XX.XXXX.02.XX.32

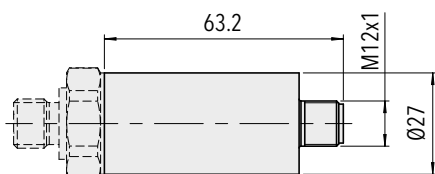
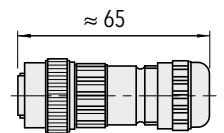

8292.XX.XXXX.35.XX.XX

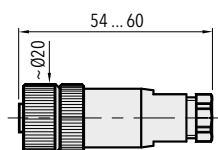

8292.XX.XXXX.XX.XX.33/35

EX PRESSURE TRANSMITTER

Swiss based Trafag is a leading international supplier of high quality sensors and monitoring instruments for measurement of pressure and temperature. The intrinsically safe EX pressure transmitter EXNA 8854 is certified to ATEX and IECEx for applications in Ex-Zones 0, 1, 2 (gas), 20, 21, 22 (dust) and mining. Due to the wide range of variants and pressure ranges from 0.1 to 1000 bar it can be configured for almost any application appropriately.



Applications

- Ex Zone 0, 1, 2 / Gas
- Ex Zone 20, 21, 22 / Dust
- Ex Underground Mining

Features

- Ex ATEX / IECEx
- Pressure ranges from 100 mbar
- Versions with frontal flush diaphragm
- Media temperature to 150°C
- EMC protection, IEC 61000

Technical Data			
Measuring principle	Piezoresistive	Ambient temperature	T3: -40°C ... +125°C T4: -40°C ... +85°C T6: -40°C ... +50°C
Measuring range	0 ... 0.1 to 0 ... 1000 bar	Approval / conformity	DNV-GL Ex according to standards, IEC/EN 60079-0 /-11/-26, EN 50303
Output signal	4 ... 20 mA	Type of protection	⊕ II 1G Ex ia IIC T3 ... T6 Ga II 1D Ex ia IIIC IP6x T145 ... T70°C I M1 Ex ia I
Media temperature	T3: -40°C ... +150°C T4: -40°C ... +100°C T6: -40°C ... +50°C		

Subject to change

Ordering information/type code

				8854 . XX	XX	XX	XX	XX	XX	
Measuring range ¹⁾	Pressure measurement range [bar]	Over pressure [bar]	Burst pressure [bar]							
	0 ... 0.1	3	200	66	0 ... 16	48	200	79		
	0 ... 0.16	3	200	67	0 ... 25	75	200	80		
	0 ... 0.2	3	200	68	0 ... 40	120	850	81		
	0 ... 0.4	3	200	69	0 ... 60	180	850	82		
	0 ... 0.6	3	200	70	0 ... 100	300	850	83		
	0 ... 1	3	200	71	0 ... 160	480	850	85		
	0 ... 1.6	4.8	200	73	0 ... 250	750	850	74		
	0 ... 2.5	7.5	200	75	0 ... 400	850	1500	84		
	0 ... 4	12	200	76	0 ... 600	850	1500	86		
	0 ... 6	18	200	77	0 ... 1000	1500	1500	88		
	0 ... 10	30	200	78						
	Sensor	Type 02 relative (Accuracy NLH BSL ± 0.25 % FS)								P2
		Type 02 absolute (Accuracy NLH BSL ± 0.25 % FS)								A2
Type 01 relative (Accuracy NLH BSL ± 0.1 % FS)								P1		
Type 01 absolute (Accuracy NLH BSL ± 0.1 % FS)								A1		
Pressure connection	1/4" NPT male								30	
	1/2" NPT male								39	
	G1/4" female								10	
	G1/4" male								15	
	G1/2" male								21	
	G1/2" male, frontal membrane								31	
	G1/2" male, flush membrane								32	
Electrical connection	Male electrical plug EN 175301-803-A, Mat. plastic								05	
	Male electrical plug Binder 723, 5-pole, Metal								14	
	Male electrical plug MIL-C 26482, 6-pole, Metal								02	
	Female electrical plug M12x1, 5-pole, Metal								35	
	PUR cable, length ... mm (IP67) ⁵⁾								22	
	FEP cable, length ... mm (IP67)								32	
Output	Signal output	Load resistance	I (supply)	U (supply)						
	4 ... 20 mA	(U _{supply} -9 V) / 20 mA		9 ... 28 VDC	19					
Accessories	Special oil filling: Aseol								94	
	Special oil filling: Halocarbon ^{3) 4)}								95	
	Female electrical connector EN 175301-803-A (DIN43650-A)								58	
	Female electrical connector Binder 723, 5-pole, metal								37	
	Female electrical connector MIL-C 26482, 6-pole, metal								32	
	Temperature class T3								T3	
	Temperature class T4								T4	
	Temperaturklasse T6								T6	
	Pressure peak damping element ²⁾								DE	
	Zener barrier 28V/93mA; R ≈ 300Ω; Ordering code F90138									

¹⁾ Customized pressure ranges upon request

²⁾ Only with pressure connection 30, 39, 15, 21

³⁾ P2/A2 ≤ 120 bar

⁴⁾ P1/A1 ≤ 270 bar

⁵⁾ ≤ +50°C

Specifications		
Electrical Data	Zener barrier	28V/93 mA/0.65 W
	Output / supply voltage	4 ... 20 mA; 9 ... 28 VDC
	Rise time	Typ. 1 ms / 10 ... 90 % nominal pressure
Environmental conditions	Media temperature	T3: -40°C ... +150°C T4: -40°C ... +100°C T6: -40°C ... +50°C
	Ambient temperature	T3: -40°C ... +125°C T4: -40°C ... +85°C T6: -40°C ... +50°C
	Protection ¹⁾	Min. IP65
	Humidity	Max. 95 % relative
	Vibration	EN 60068-2-6: 10 g (4...2000 Hz)
	Shock	EN 60068-2-27: 100 g/ 6 ms
	EMC Protection	Emission
	Immunity	IEC 61000-4-2: 8 kV K./15 kV L.
Mechanical Data	Sensor (wetted parts)	1.4435 (AISI316L) or titanium
	Pressure connection (wetted parts)	1.4435 (AISI316L) or titanium
	Housing	1.4435 (AISI316L) or titanium
	Sealing	FKM 70 Sh; EPDM / Kalrez
	Male electrical plug	See ordering information
	Weight	~ 220 g
	Mounting torque	25 Nm

¹⁾ Provided female connector is mounted according to instructions

Accuracy						
		Sensor 01 (P1/A1) NLH ± 0.1 %				
Pressure measuring range	[bar]	0.1 ... 0.5	0.5 ... 2	2 ... 100	100 ... 600	> 600
NLH @ +25°C (BSL through 0)	[% FS typ.]	± 0.1	± 0.1	± 0.1	± 0.1	-
TEB @ 0 ... +70°C	[% FS typ.]	± 0.8	± 0.3	± 0.3	± 0.3	± 0.3
TEB @ -25 ... +100°C	[% FS typ.]	± 1.3	± 0.75	± 0.75	± 0.75	± 0.75
Long term stability 1 year		< 4 mbar	< 4 mbar	< 0.2 % FS	< 0.2 % FS	< 0.2 % FS
Repeatability	[% FS typ.]	± 0.05	± 0.05	± 0.05	± 0.05	± 0.05
		Sensor 02 (P2/A2) NLH ± 0.25 %				
Pressure measuring range	[bar]	0.1 ... 0.5	0.5 ... 2	2 ... 100	100 ... 600	> 600
NLH @ +25°C (BSL through 0)	[% FS typ.]	± 0.25	± 0.25	± 0.25	± 0.25	± 0.25
TEB @ 0 ... +70°C	[% FS typ.]	± 1.0	± 0.7	± 0.7	± 0.7	± 0.7
TEB @ -25 ... +100°C	[% FS typ.]	± 2.0	± 1.0	± 1.0	± 1.0	± 1.0
Long term stability 1 year		< 4 mbar	< 4 mbar	< 0.2 % FS	< 0.2 % FS	< 0.2 % FS
Repeatability	[% FS typ.]	± 0.05	± 0.05	± 0.05	± 0.05	± 0.05

Dimensions

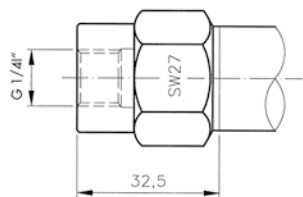

8854.XX.XX10.XX.XX.XX

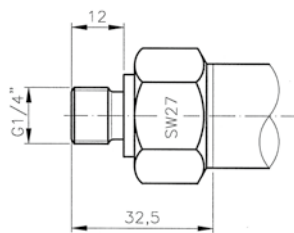

8854.XX.XX15.XX.XX.XX

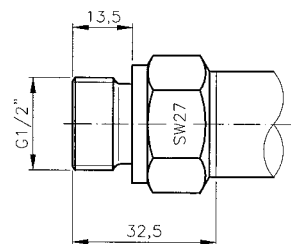

8854.XX.XX21.XX.XX.XX

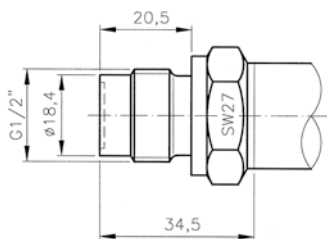

8854.XX.XX31.XX.XX.XX

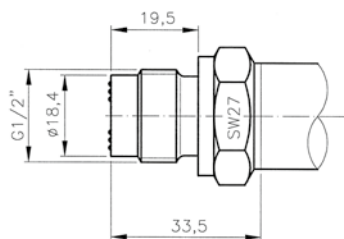

8854.XX.XX32.XX.XX.XX

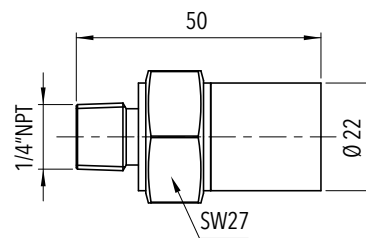

8854.XX.XX30.XX.XX.XX

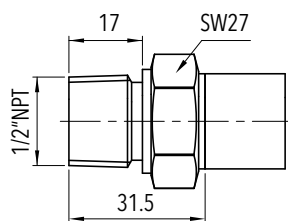

8854.XX.XX39.XX.XX.XX

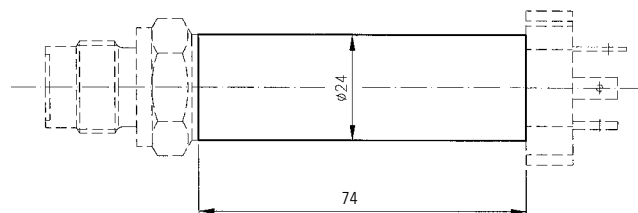

8854.XX.XXXX.XX.XX.T4

8854.XX.XXXX.XX.XX.T6

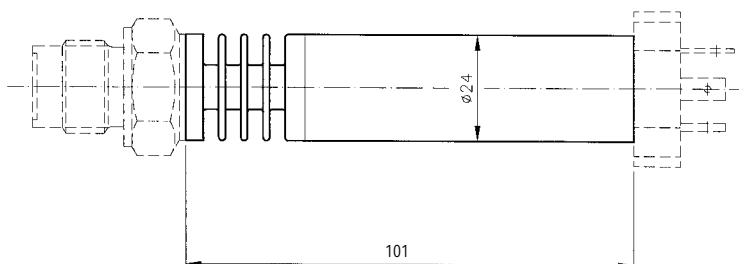

8854.XX.XXXX.XX.XX.T3

Dimensions

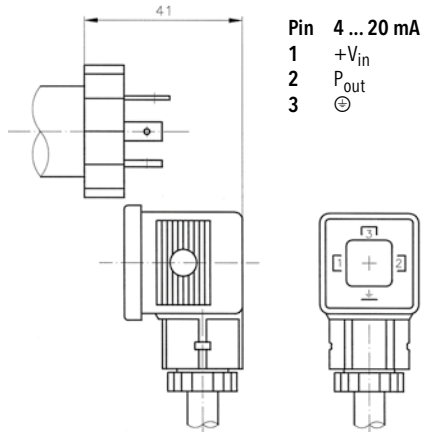

8854.XX.XXXX.05.XX.58

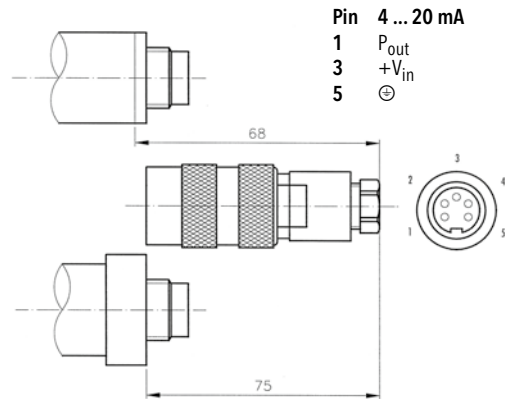

8854.XX.XXXX.14.XX.37

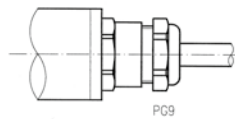

Color 4 ... 20 mA
 white +V_{in}
 yellow P_{out}
 grey ⊖

8854.XX.XXXX.32.XX.XX

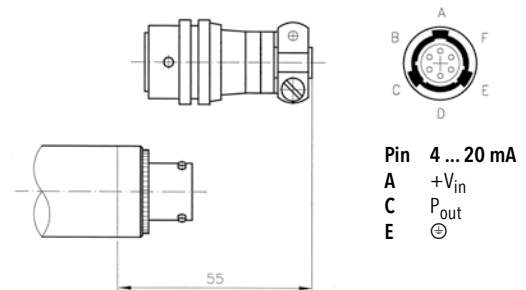

8854.XX.XXXX.02.XX.32

Electrical Connection

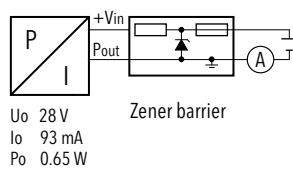

Additional information

Documents

Data sheet	www.trafag.com/H72334
Instructions	www.trafag.com/
Flyer	www.trafag.com/H70679

EX SUBMERSIBLE PRESSURE TRANSMITTER

Swiss based Trafag is a leading international supplier of high quality sensors and monitoring instruments for measurement of pressure and temperature. The new EX Submersible Pressure Transmitter EXL is based on the ECL submersible pressure transmitter with Trafag's own thick-film-on-ceramic sensor technology. The intrinsic safety design is certified for applications in Ex-Zones 0, 1, 2 (gas) and mining.



Applications

- Ex Zone 0, 1, 2 / Gas
- Ex Underground Mining

Features

- II 1G Ex ia IIC T4/T6 Ga
I M1 Ex ia I Ma
- Good media compatibility
- Cable PUR/PE or FEP
- EMC protection, IEC 61000

Technical Data			
Measuring principle	Thick film on ceramic	Media temperature	T4: -20°C ... +70°C T6: -20°C ... +65°C
Measuring range	0 ... 0.2 to 0 ... 10 bar	Ambient temperature	T4: -20°C ... +70°C T6: -20°C ... +65°C
Output signal	4 ... 20 mA	Approval / conformity	GL, KRS Ex ATEX/IECEx, EN 60079-0/ EN 60079-11/EN 60079-26/ EN 50303
Accuracy @ 25°C typ.	± 0.3 % FS typ. ± 0.5 % FS typ.		

Subject to change

Ordering information/type code

				8432 . XX	XX	XX	XX	XX	XX
Measuring range ¹⁾	Pressure measurement range [bar]	Over pressure [bar]	Burst pressure [bar]						
	0 ... 0.2	1.2	2	68					
	0 ... 0.4	1.2	2	69					
	0 ... 0.6	2	3	70					
	0 ... 1.0	3.2	4.8	71					
	0 ... 1.6	3.2	4.8	73					
	0 ... 2.5	5	7.5	75					
	0 ... 4	8	12	76					
	0 ... 6	12	15	77					
0 ... 10	20	25	78						
Sensor	Relative pressure > 400 mbar, Accuracy: 0.3%			23					
	Relative pressure ≤ 400 mbar, Accuracy: 0.5%			26					
Pressure connection	Type 1, female, M 10x1, 1.4404/1.4435				46				
	Type 2, male, M 22x1, 1.4404/1.4435				48				
Electrical connection	Cable with shield: PUR ø 6 mm, 5x0.22mm ^{2 2) 3)}						22		
	Cable with shield: FEP ø 6 mm, 5x0.22mm ^{2 2) 3)}						32		
	Cable with shield: PE ø 6 mm, 6x0.22mm ^{2 2) 3)}						42		
Output	Signal output	Load resistance	I (supply)	U (supply)					
	4 ... 20 mA	(U _{supply} -10 V) / 20 mA		10 ... 30 VDC					19
Accessories	Seal FKM								61
	Seal EPDM								63
	Zener barrier 28V/93mA; R ≈ 300Ω: Ordering no ZEN28VDC								

¹⁾ Extended overpressure as well as customized pressure ranges upon request

²⁾ Please specify cable length when ordering (cable lengths >50 m up to 120 m upon request)

³⁾ For level measurement applications on ships under certification GL (German Lloyd), the cable of such transmitters must be installed inside the tank only

Specifications		
Electrical Data	Output / supply voltage	4 ... 20 mA; 24 (10 ... 30) VDC
	Rise time	Typ. 1 ms / 10 ... 90 % nominal pressure
	Switch-on-delay	max. 1.5 s
Environmental conditions	Media temperature	T4: -20°C ... +70°C T6: -20°C ... +65°C
	Ambient temperature	T4: -20°C ... +70°C T6: -20°C ... +65°C
	Protection	IP68 (25 bar; 250m)
	Vibration	10 g (50...2000 Hz)
	Shock	50 g / 3 ms
EMC Protection	Emission	IEC 61000-6-4
	Immunity	IEC 61000-6-2
Mechanical Data	Sensor (wetted parts)	Ceramic, Al ₂ O ₃ (96 %)
	Pressure connection (wetted parts)	1.4404/1.4435 (AISI316L)
	Housing	1.4404/1.4435 (AISI316L)
	Sealing	FKM 70 Sh
	Weight	~ 200 g

Accuracy			
		Measuring accuracy 0.3 % Ordering No. 23	Measuring accuracy 0.5 % Ordering No. 26
TEB @ -10 ... +70°C	[% FS typ.]	± 0.75	± 1.5
Accuracy @ +25°C	[% FS typ.]	± 0.3	± 0.5
NLH @ +25°C (BSL)	[% FS typ.]	± 0.2	± 0.3
TC zero point and span	[% FS/K typ.]	± 0.02	± 0.02
Long term stability 1 year @ +25°C	[% FS typ.]	± 0.2	± 0.2

Measuring accuracy 0.5%

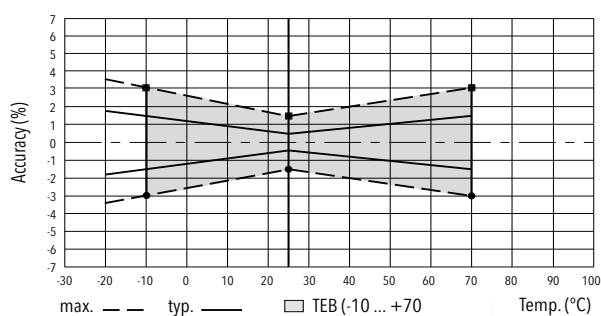

Measuring accuracy 0.3%

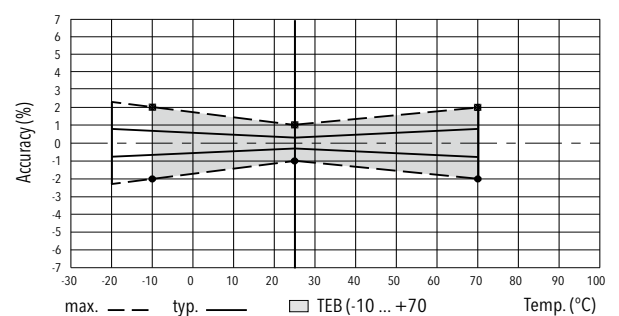

Dimensions

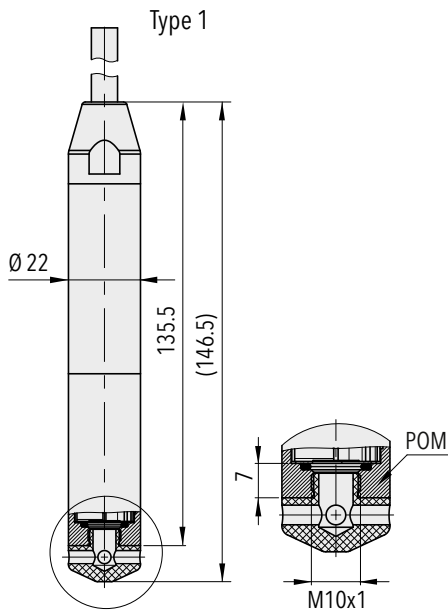

8432.XX.XX46.XX.XX.XX

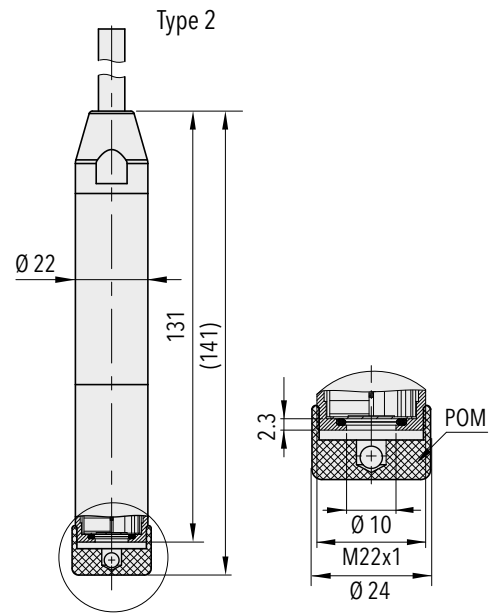

8432.XX.XX48.XX.XX.XX

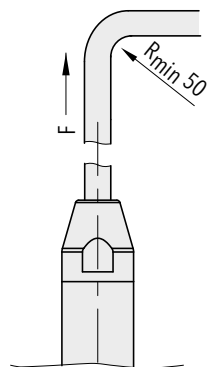

8432.XX.XXXX.22.XX.XX

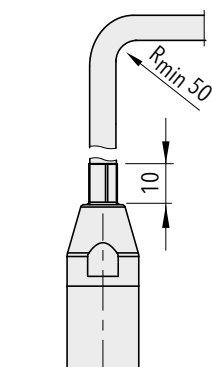

8432.XX.XXXX.32/42.XX.XX

Electrical connection

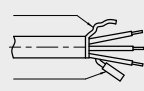
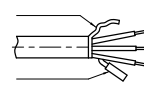
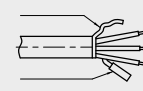
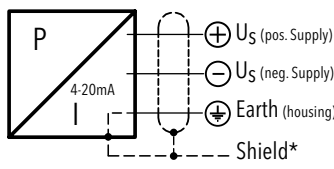
				Protection / electrical connection		
				IP68 (25 bar; 250m)	IP68 (25 bar; 250m)	IP68 (25 bar; 250m)
				Cable PUR Ø 6 mm (5x0.22mm ²) 22	Cable FEP Ø 6 mm (5x0.22mm ²) 32	Cable PE Ø 6 mm (6x0.22mm ²) 42
				Shield 	Shield 	Shield 
				Venting	Venting	Venting
Output signal	 <p>8432.xx.xxxx.xx.19</p>	white brown yellow (green = not connected) (red = not connected)	white brown yellow (green = not connected) (red = not connected)	white brown yellow (green = not connected) (pink = not connected) (grey = not connected)		
		Temperature range	-20 ... +70°C	-20 ... +70°C	-20 ... +70°C	

Any manipulation on the ventilation tube will result in warranty loss

***) For all cable versions

Ex-Barrier

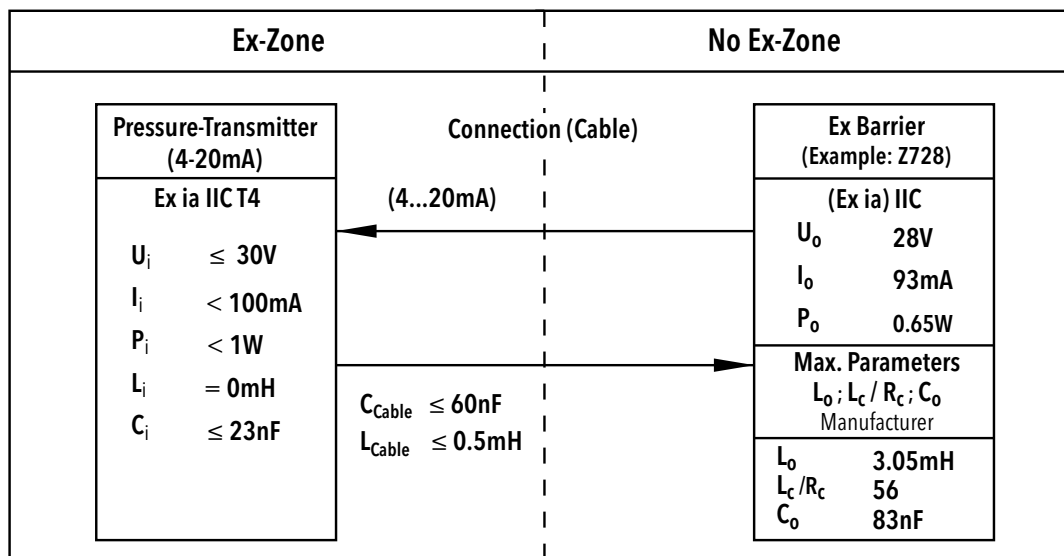

Additional information

Documents		
	Data sheet	www.trafag.com/H72330
	Instructions	www.trafag.com/H73329
	Flyer	www.trafag.com/H70658

EX SUBMERSIBLE PRESSURE TRANSMITTER

Swiss based Trafag is a leading international supplier of high quality sensors and monitoring instruments for measurement of pressure and temperature.



Applications

- Shipbuilding
- Ex SEV 11 ATEX 0145 X

Features

- Pressure ranges from 100 mbar
- PUR, PE or Teflon cables
- Chemical resistant material, e.g. titanium
- Explosion-proof Ex ia IIC T3 ... T6
- Option: Lightning protection (IEC 61000-4-5), 10kA (8/20 μs)

Technical Data			
Measuring principle	Piezoresistive	Ambient temperature	T4/T6: -5°C ... +50°C
Measuring range	0 ... 0.1 to 0 ... 25 bar	Approval / conformity	GL, KRS
Output signal	4 ... 20 mA	Type of protection	 II 1G Ex ia IIC T3 ... T6 II 1D Ex ia IIIC IP6x T125°C ... T80°C I M1 Ex ia I
Media temperature	T4/T6: -5°C ... +50°C		

Subject to change

Ordering information/type code

				8858 .	XX	XX	XX	XX	XX	XX
Measuring range ¹⁾	Pressure measurement range	Over pressure	Burst pressure							
	[bar]	[bar]	[bar]							
	0 ... 0.1	3	200	66						
	0 ... 0.16	3	200	67						
	0 ... 0.2	3	200	68						
	0 ... 0.4	3	200	69						
	0 ... 0.6	3	200	70						
	0 ... 1	3	200	71						
	0 ... 1.6	4.8	200	73						
	0 ... 2.5	7.5	200	75						
	0 ... 4	12	200	76						
	0 ... 6	18	200	77						
	0 ... 10	30	200	78						
	0 ... 16	48	200	79						
0 ... 25	75	200	80							
Sensor	Type 01, relative pressure (accuracy NLH: ± 0.1 % FS) ²⁾				P1					
	Type 02, relative pressure (accuracy NLH: ± 0.25 % FS) ²⁾				P2					
	Type 05, relative pressure (Accuracy NLH: ± 0.5 % FS) ²⁾				P5					
Pressure connection	Open					40				
	Closed					41				
	G1/4" male					15				
Electrical connection	Cable PUR ³⁾						22			
	Cable PE ³⁾						29			
	Cable Teflon ³⁾						32			
Output signal	Signal output	Load resistance	I (supply)	U (supply)						
	4 ... 20 mA								19	
	4 ... 20 mA with lightning protection (Surge)								09	
Accessories	Special oil filling: Aseol ⁴⁾									94
	Special oil filling: Halocarbon ⁴⁾									95
	Temperature class T4 ⁴⁾									T4
	Temperaturklasse T6 ⁴⁾									T6
	Application for seawater ⁴⁾									

¹⁾ Customized pressure ranges upon request

²⁾ Accuracy NLH see table

³⁾ Please specify the cable length when ordering

⁴⁾ Please specify the measuring medium when ordering

Specifications		
Electrical Data	Repeatability	± 0.05 % FS
	Zener barrier	30 VDC/ 100mA/ 1W
	Load	4 ... 20 mA: $R_L \leq (U_S - 9V)/20 \text{ mA}$
	Rise time	Typ. 1 ms / 10 ... 90 % nominal pressure
Environmental conditions	Media temperature	T4/T6: -5°C ... +50°C
	Ambient temperature	T4/T6: -5°C ... +50°C
	Protection	Min. IP68
	Humidity	Max. 95 % relative
	Vibration	6 g (25...2000 Hz)
	Shock	50 g / 1 ms
EMC Protection	Burst	EN/IEC 61000-4-4, Level 3
	Surge	EN/IEC 61000-4-5, Level 3 $R_i = 42\Omega$
	Emission	EN/IEC 61000-6-3
	Immunity	EN/IEC 61000-6-2
Mechanical Data	Sensor (wetted parts)	1.4435 (AISI316L)
	Pressure connection (wetted parts)	1.4435 (AISI316L) or titanium
	Housing	1.4435 (AISI316L) or titanium
	Sealing	FKM
	Male electrical plug	See ordering information
	Weight	~ 200 g
	Mounting torque	25 Nm

Accuracy				
Range	[bar]	0.1 ... 0.5	0.5 ... 2	2 ... 25
Accuracy NLH (BSL through 0) P5	[± % FS]	± 0.5	± 0.5	± 0.5
Accuracy NLH (BSL through 0) P2	[± % FS]	± 0.25	± 0.25	± 0.25
Accuracy NLH (BSL through 0) P1	[± % FS]	-	± 0.1	± 0.1
Temperature coefficient Zero point -5 ... +50°C	[± % FS/K]	± 0.06	± 0.03	± 0.015
Temperature coefficient Span -5 ... +50°C	[± % FS/K]	± 0.015	± 0.015	± 0.015
Long term drift	[1 year]	< 4 mbar	< 4 mbar	< 0.2 % FS

Additional information		
Documents	Data sheet	www.trafag.com/H72231
	Instructions	www.trafag.com/
	Flyer	www.trafag.com/

Dimensions

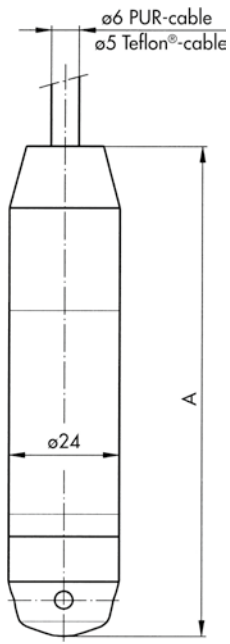

8858.XX.XX.41.XX.XX.XX

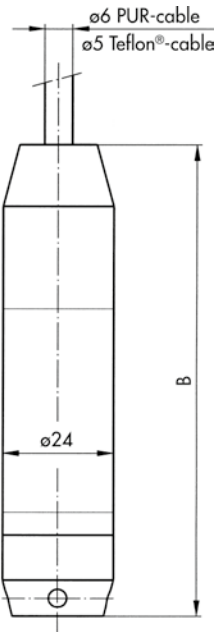

8858.XX.XX.40.XX.XX.XX

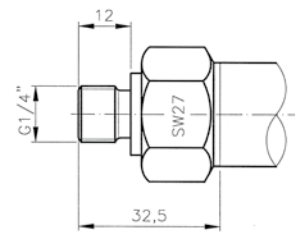

8858.XX.XX.15.XX.XX.XX

	A [mm]	B [mm]
Standard	113	109
With lightning protection	157	153

Electrical connection

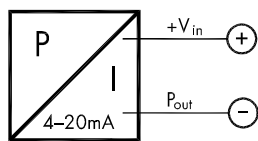

Color 4 ... 20 mA

white +V_{in}
 yellow P_{out}
 brown ⊕

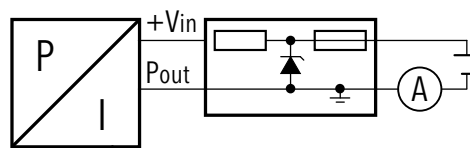

Zener barrier

SUBMERSIBLE PRESSURE TRANSMITTER

Swiss based Trafag is a leading international supplier of high quality sensors and monitoring instruments for measurement of pressure and temperature. The new Submersible Pressure Transmitter ECL is based on Trafag's own thick-film-on-ceramic technology. Together with the inhouse developed high performance ASIC chip electronics it ensures a high level of accuracy over a wide temperature range.



Applications

- Process technology
- Water treatment



Features

- Good media compatibility
- Economical
- Cable PUR/PE or FEP
- Lightning protection integrated

Technical Data

Measuring principle	Thick film on ceramic	Media temperature	-25°C ... +80°C (+70°C)
Measuring range	0 ... 0.1 to 0 ... 10 bar	Ambient temperature	-25°C ... +80°C (+70°C)
Output signal	4 ... 20 mA	Approval / conformity	GL, KRS
Accuracy @ 25°C typ.	± 0.3 % FS typ. Range 0...0.1 to 0...0.4 bar: ± 0.5 % FS typ.		

Subject to change

Ordering information/type code

				8438 .	XX	XX	XX	XX	XX	XX
Measuring range ¹⁾	Pressure measurement range [bar]	Over pressure [bar]	Burst pressure [bar]							
	0 ... 0.1	1.2	2	66						
	0 ... 0.16	1.2	2	67						
	0 ... 0.2	1.2	2	68						
	0 ... 0.4	1.2	2	69						
	0 ... 0.6	1.2	2	70						
	0 ... 1.0	2	3	71						
	0 ... 1.6	3.2	4.8	73						
	0 ... 2.5	5	7.5	75						
	0 ... 4	8	12	76						
	0 ... 6	12	15	77						
0 ... 10	20	25	78							
Sensor	Relative pressure > 400 mbar, accuracy 0.3%									23
	Relative pressure ≤ 400 mbar, accuracy: 0.5%									26
Pressure connection	Type 1, female, M 10x1, 1.4404/1.4435									46
	Type 2, male, M 22x1, 1.4404/1.4435									48
Electrical connection	Cable: PUR ø 6 mm ^{2) 3)}									22
	Cable: FEP ø 6 mm ^{2) 3)}									32
	Cable: PE ø 6 mm ^{2) 3)}									42
Output	Signal output	Load resistance	I (supply)	U (supply)						
	4 ... 20mA	(U _{supply} -9V) / 20mA		9 ... 30 VDC						19
Accessories	Seal FKM									61
	Seal CR									62
	Seal EPDM									63

¹⁾ Extended overpressure as well as customized pressure ranges upon request

²⁾ Please specify cable length when ordering (cable lengths >50 m up to 120 m upon request)

³⁾ For level measurement applications on ships under certification GL (German Lloyd), the cable of such transmitters must be installed inside the tank only

Standard products (extra short lead time)

Product No.	Type Code	Pressure range [bar]	Over pressure max. [bar]	Supply [VDC]	Cable length
ECL0.2A	8438 68 2646 22 0000 0000 19 61 5M	0...0.2	2	9...30	5m
ECL0.5A	8438 21 2346 22 0000 0000 19 61 8M 01	0...0.5	2	9...30	10m

Specifications		
Electrical Data	Output / supply voltage	4 ... 20 mA; 24 (9 ... 32) VDC
	Rise time	Typ. 1 ms/10...90 % nominal pressure
	Switch-on-delay	Max. 1.5 s
Environmental conditions	Media temperature	-25°C ... +80°C (+70°C)
	Ambient temperature	-25°C ... +80°C (+70°C)
	Protection	IP68 (25 bar; 250m)
	Vibration	6g (25...2000 Hz)
	Shock	50g/ 8 ms
EMC Protection	Emission	EN/IEC 61000-6-3
	Immunity	EN/IEC 61000-6-2
Mechanical Data	Sensor (wetted parts)	Ceramic, Al ₂ O ₃ (96 %)
	Pressure connection (wetted parts)	1.4404/1.4435 (AISI316L)
	Housing	1.4404/1.4435 (AISI316L)
	Sealing	FKM 70 Sh CR, EPDM
	Weight	~ 200 g

Accuracy			
		Measuring accuracy 0.3%	Measuring accuracy 0.5%
		Ordering No. 23	Ordering No. 26
TEB @ -10...+80°C	[% FS typ.]	± 1.0	± 2.0
Accuracy @ +25°C	[% FS typ.]	± 0.3	± 0.5
NLH @ +25°C (BSL)	[% FS typ.]	± 0.2	± 0.3
TC zero point and span	[% FS/K typ.]	± 0.02	± 0.02
Long term stability 1 year @ +25°C	[% FS typ.]	± 0.2	± 0.2

Measuring accuracy 0.5%

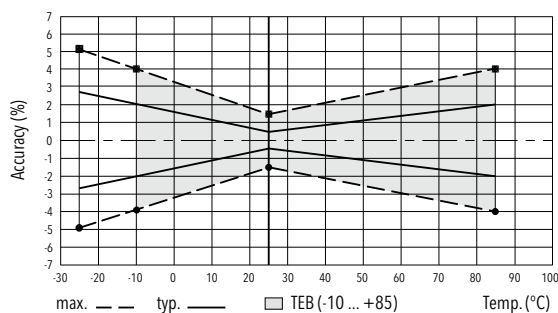

Measuring accuracy 0.3%

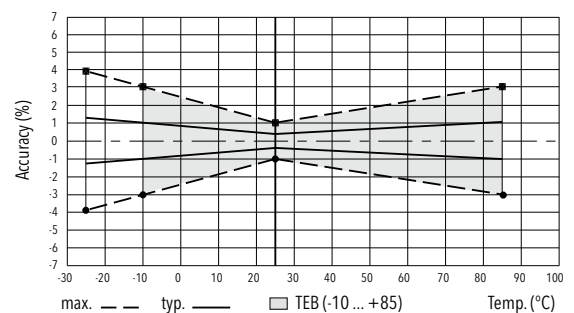

Dimensions

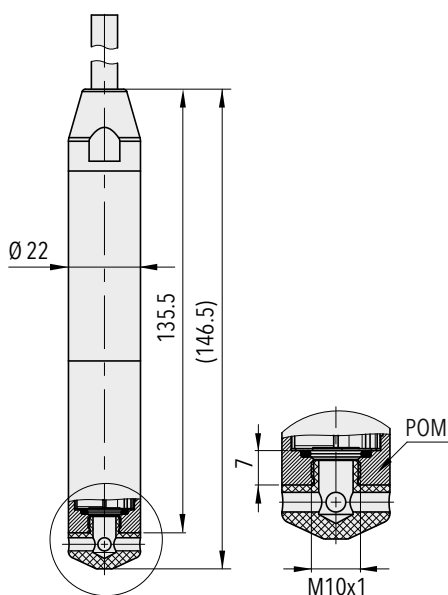

8438.XX.XX46.XX.XX.XX

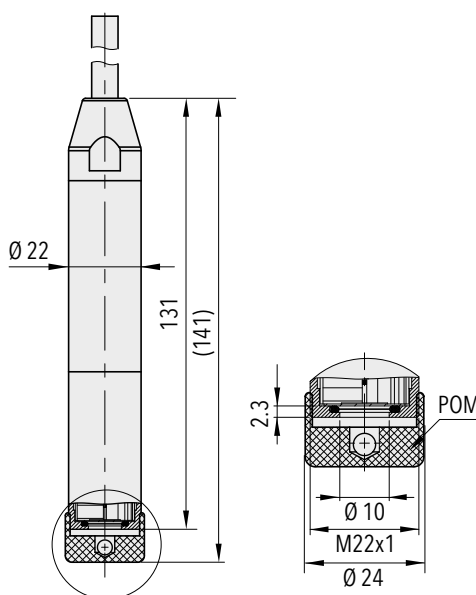

8438.XX.XX48.XX.XX.XX

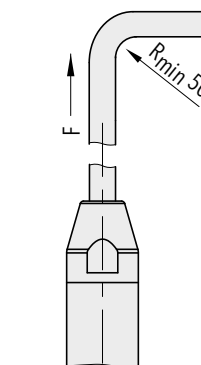

F = max. 12 kg (120 N)

Electrical Connection

				Protection / electrical connection		
				IP68 (25 bar; 250m)	IP68 (25 bar; 250m)	IP68 (25 bar; 250m)
				Cable PUR Ø 6 mm (5x0.22mm ²) 22	Cable FEP Ø 6 mm (5x0.22mm ²) 32	Cable PE Ø 6 mm (5x0.22mm ²) 42
				Shield	Shield	Shield
Output signal		8438.XX.XXXX.XX.19		white	white	white
				brown	brown	brown
			yellow	yellow	yellow	
			(green = not connected) (red = not connected)	(green = not connected) (red = not connected)	(green = not connected) (red = not connected)	
Temperature range			-25 ... +70°C	-25 ... +80°C	-25 ... +70°C	

Any manipulation on the ventilation tube will result in warranty loss

***) For all cable versions

Additional information

Documents		
	Data sheet	www.trafag.com/H72328
	Instructions	www.trafag.com/H73328
	Flyer	www.trafag.com/H70641

SUBMERSIBLE PRESSURE TRANSMITTER

Swiss based Trafag is a leading international supplier of high quality sensors and monitoring instruments for measurement of pressure and temperature. The new Submersible Pressure Transmitter ECL is based on Trafag's own thick-film-on-ceramic technology. The optionally configurable pressure ranges can be adapted individually via interface tool and Smartphone App.



OEM-version

Applications

- Process technology
- Water treatment (wastewater, grey-water, drinking water)
- Seawater
- Level of oils and fuels

Features

- Suitable for thick and viscous media
- Different materials for optimum media compatibility
- Lightning protection integrated
- Configurable measuring ranges

Technical Data

Measuring principle	Thick film on ceramic	Accuracy @ 25°C typ.	± 0.3 % FS typ. Range 0 ... 0.1 to 0 ... 0.2 bar: ± 0.5 % FS typ.
Measuring range	0 ... 0.1 to 0 ... 2.0 bar 0 ... 1.5 to 0 ... 30 psi	Media temperature	max. -25°C ... +70°C
Output signal	4 ... 20 mA	Ambient temperature	max. -25°C ... +70°C

Subject to change

Ordering information/type code

				8439 . XX	XX	XX	XX	XX	XX	
Measuring range ¹⁾	Pressure measurement range [bar]	Over pressure [bar]	Burst pressure [bar]	Pressure measurement range [psi]	Over pressure [psi]	Burst pressure [psi]				
	0 ... 0.1	1.2	2	0 ... 1.5	15	30	F6			
	0 ... 0.16	1.2	2	0 ... 2	15	30	F7			
	0 ... 0.2	1.2	2	0 ... 2.5	15	30	F8			
	0 ... 0.4	1.2	2	0 ... 5	15	30	F9			
	0 ... 0.5	1.2	2	0 ... 6.5	15	30	F4			
	0 ... 0.6	1.2	2	0 ... 7.5	15	30	G0			
	0 ... 1.0	2	3	0 ... 15	30	45	G1			
	0 ... 1.6	3.2	4.8	0 ... 20	45	70	G3			
	0 ... 2.0	3.2	4.8	0 ... 30	45	70	G2			
Configurable measuring ranges Standard, see table on page 3										
Sensor	Relative pressure									23
Housing	Housing AISI316L, standard version ²⁾									58
	Housing 1.4462, standard version ^{2) 3)}									55
	Housing AISI316L, OEM-version ²⁾									56
	Housing 1.4462, OEM-version ^{2) 3)}									50
	Housing AISI316L, Serto Connection ^{2) 3)}									60
Electrical connection	Cable PUR, Ø 6 mm, L = 5 m			Cable Radox, Ø 6 mm, L = 25 m						35
	Cable PUR, Ø 6 mm, L = 10 m			Cable Radox, Ø 6 mm, L = 30 m						36
	Cable PUR, Ø 6 mm, L = 15 m			Cable Radox, Ø 6 mm, customized (L = max. 50 m)						30
	Cable PUR, Ø 6 mm, L = 20 m			Cable PE, Ø 6 mm, L = 5 m						41
	Cable PUR, Ø 6 mm, L = 25 m			Cable PE, Ø 6 mm, L = 10 m						42
	Cable PUR, Ø 6 mm, L = 30 m			Cable PE, Ø 6 mm, L = 15 m						43
	Cable PUR, Ø 6 mm, customized (L = max. 50 m)			Cable PE, Ø 6 mm, L = 20 m						44
	Cable Radox, Ø 6 mm, L = 5 m			Cable PE, Ø 6 mm, L = 25 m						45
	Cable Radox, Ø 6 mm, L = 10 m			Cable PE, Ø 6 mm, L = 30 m						46
	Cable Radox, Ø 6 mm, L = 15 m			Cable PE, Ø 6 mm, customized (L = max. 50 m)						40
	Cable Radox, Ø 6 mm, L = 20 m									
	Output signal	4 ... 20 mA								
Accessories	Seal FKM / FPM / Viton									61
	Seal EPDM / TPE									63

¹⁾ Extended overpressure as well as customized pressure ranges upon request

²⁾ See "Dimensions"

³⁾ Upon request

Configurable measuring ranges standard

Pressure measuring range minimal	Pressure measuring range max. (nominal range)	Overpressure	Burst pressure	Ordering no.
0 ... 0.1	0 ... 0.3	1.2	2	C1
0 ... 0.15	0 ... 0.4	1.2	2	C2
0 ... 0.2	0 ... 0.6	1.2	2	C3
0 ... 0.35	0 ... 1.0	2	3	C4
0 ... 0.6	0 ... 1.6	3.2	4.8	C5
0 ... 0.85	0 ... 2.0	3.2	4.8	C6

All accuracy indications refer to the nominal measurement range and the respective span. When minimizing the span, the relative errors are increasing in relation of the maximum to the selected span.

Configuration of the measuring ranges

All measurement ranges can be configured via Smartphone app (Android). The SMI Sensor Master Interface as well as the Smartphone, which are necessary for the configuration, are not part of the delivery. The Android app is available for free in the Google Play Store.



- Ordering No. SMI Sensor Master Interface: F90170 (available from the 2nd quarter of 2018)
- Data sheet SMI Sensor Master Interface: H72618

Type	Type code	Housing	Cable material	Seal	Typical applications
Standard ¹⁾ OEM ¹⁾ Serto	8439.XX.2358.2X.19.61.XX 8439.XX.2356.2X.19.61.XX 8439.XX.2360.2X.19.61.XX	AISI316L	PUR	FKM / Viton	General applications
Standard OEM Serto	8439.XX.2358.3X.19.61.XX 8439.XX.2356.3X.19.61.XX 8439.XX.2360.3X.19.61.XX	AISI316L	Radox	FKM / Viton	Oils and fuels
Standard OEM Serto	8439.XX.2358.4X.19.63.XX 8439.XX.2356.4X.19.63.XX 8439.XX.2360.4X.19.63.XX	AISI316L	PE	EPDM / TPE	Wastewater, grey-water, drinking water
Standard OEM	8439.XX.2355.4X.19.63.XX 8439.XX.2350.4X.19.63.XX	1.4462	PE	EPDM / TPE	Seawater, Saline water
Standard OEM	8439.XX.23.55.3X.19.63.XX 8439.XX.23.50.3X.19.63.XX	1.4462	Radox	EPDM / TPE	Marine applications ²⁾

Non-standard build-up combinations may be selected, whereas minimum order quantities may apply

¹⁾ Extra short lead time

²⁾ Cable PUR or PE only usable inside tank

Specifications		
Electrical Data	Output / supply voltage	4...20 mA: 24 (9...32) VDC
	Rise time	Typ. 1 ms / 10 ... 90 % nominal pressure
	Switch-on-delay	100 ms
Environmental conditions	Media temperature ¹⁾	max. -25°C ... +70°C
	Ambient temperature	max. -25°C ... +70°C
	Protection	IP68 (2.0 bar/20 m)
	Vibration	20 g (40 ... 2000 Hz) 15 grms (20 ... 2000 Hz)
	Shock	50 g / 8 ms
EMC Protection	Emission	EN/IEC 61000-6-3 / DNVGL-CG-0339
	Immunity	EN/IEC 61000-6-2 / DNVGL-CG-0339
Mechanical Data	Sensor (wetted parts)	Ceramic, Al ₂ O ₃ (96%)
	Pressure connection (wetted parts)	1.4404 (AISI316L) or 1.4462 (AISI318LN)
	Housing	1.4404 (AISI316L) or 1.4462 (AISI318LN)
	Sealing	FKM (FPM, Viton), EPDM (TPE)
	Weight	~ 200 g (without cable) / OEM ~ 150 g

¹⁾ see table Temperature ranges

Temperature ranges		
Max. ambient and media temperature		-25°C ... +70°C
Cable PE	Code 8439.XX.23.XX.4X.19.XX	-20°C ... +65°C
Seal FKM with standard version	Code 8439.XX.23.55.XX.19.61 Code 8439.XX.23.58.XX.19.61	-20°C ... +70°C
Seal FKM with Serto connection	Code 8439.XX.23.60.XX.19.61	

Accuracy			
		Measuring accuracy 0.3 % Measuring ranges ≥ 0.3 bar	Measuring accuracy 0.5 % Measuring ranges < 0.3 bar
TEB @ -25 ... +70°C	[% FS typ.]	± 1.0	± 2.0
Accuracy @ +25°C	[% FS typ.]	± 0.3	± 0.5
NLH @ +25°C (BSL)	[% FS typ.]	± 0.2	± 0.3
TC zero point and span	[% FS/K typ.]	± 0.02	± 0.02
Long term stability 1 year @ +25°C	[% FS typ.]	± 0.2	± 0.2

The indications of instruments with configurable measuring ranges refer always to the span of the maximum measuring range. When minimizing the span, the relative errors are increasing in relation of the maximum to the selected span.

Measuring accuracy 0.5 %

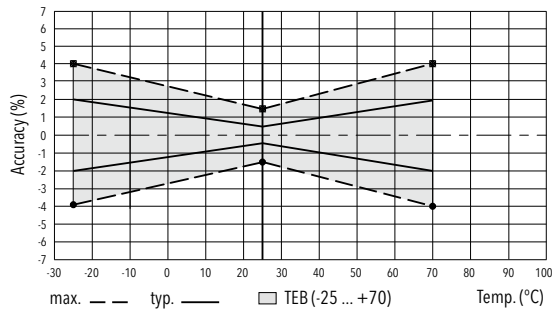

Measuring accuracy 0.3 %

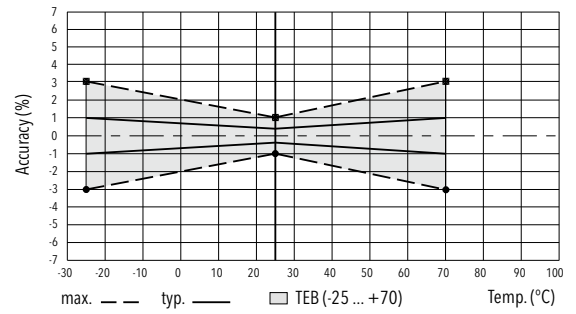

Dimensions

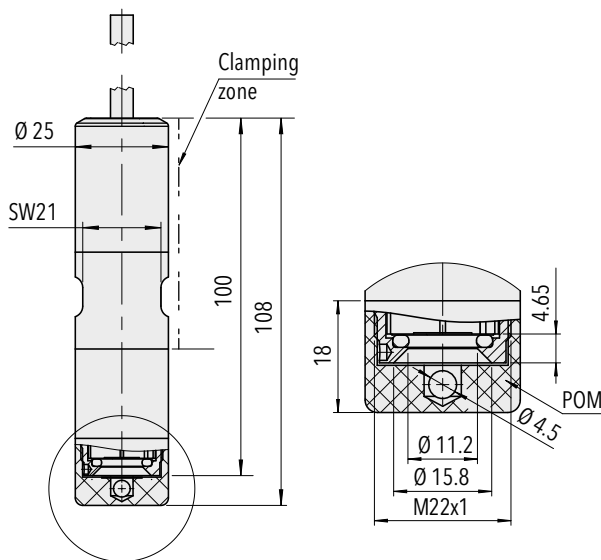

8439.XX.XX58/55.XX.XX.XX

Standard version

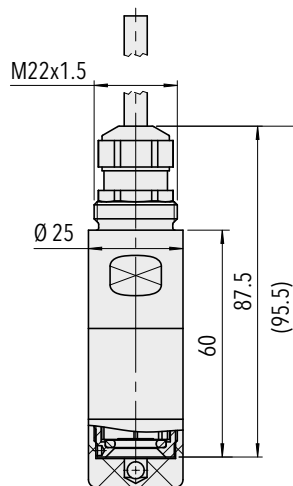

8439.XX.XX56/50.XX.XX.XX

OEM-version

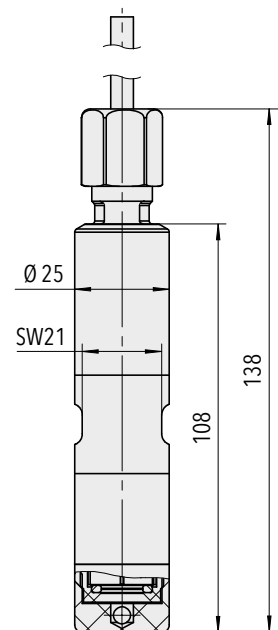

8439.XX.XX60.XX.XX.XX

Serto adapter SO 50021-12
for stainless steel tubes with:
outer diameter 12 mm
inner diameter 8 mm

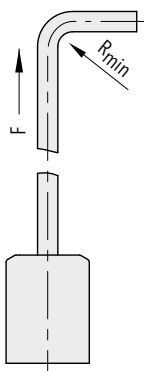

F = max. 12 kg (120 N)

Electrical connection

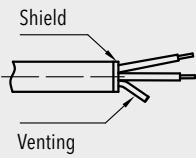
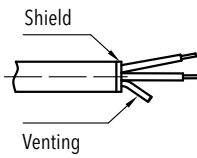
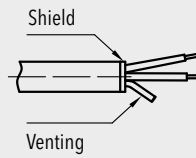
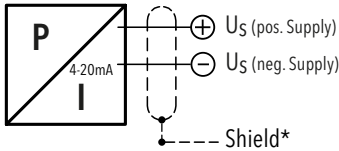
		Protection / electrical connection		
		IP68 (2.0 bar/20 m)	IP68 (2.0 bar/20 m)	IP68 (2.0 bar/20 m)
		Cable PUR Ø 6 mm (5x0.22mm ²)	Cable Radox Ø 6 mm (5x0.22mm ²)	Cable PE Ø 6 mm (5x0.22mm ²)
		2X	3X	4X
				
Output signal		white brown	white brown	white brown
	8439.XX.XXXX.XX.19	(yellow = not connected) (green = not connected) (red = not connected)	(yellow = not connected) (green = not connected) (red = not connected)	(yellow = not connected) (green = not connected) (red = not connected)
	Minimum cable bending radius R _{min}	40 mm	60 mm	30 mm
T-Range	Ambient and media temperature	-25°C ... +70°C	-25°C ... +70°C	-20°C ... +65°C

* Shield not connected

Additional information

Documents	Data sheet	www.trafag.com/H72336
	Instructions	www.trafag.com/H73336
	Flyer	www.trafag.com/H70690

SUBMERSIBLE PRESSURE TRANSMITTER

Swiss based Trafag is a leading international supplier of high quality sensors and monitoring instruments for measurement of pressure and temperature.



Applications

- Shipbuilding
- Process technology
- Water treatment

Features

- Low pressure ranges (to 100 mbar)
- No media contacting O-rings
- PUR or Teflon cables
- Option: Chemical resistant material, e.g. titanium
- Option: Lightning protection (IEC 61000-4-5)

Technical Data

Measuring principle	Piezoresistive	Media temperature	-5°C ... +50°C
Measuring range	0 ... 0.1 to 0 ... 25 bar	Ambient temperature	-5°C ... +50°C
Output signal	4 ... 20 mA 0 ... 10 VDC	Approval / conformity	GL, KRS

Subject to change

Ordering information/type code

				8838 .	XX	XX	XX	XX	XX	XX
Measuring range ¹⁾	Pressure measurement range [bar]	Over pressure [bar]	Burst pressure [bar]							
	0 ... 0.1	3	200	66						
	0 ... 0.16	3	200	67						
	0 ... 0.2	3	200	68						
	0 ... 0.4	3	200	69						
	0 ... 0.6	3	200	70						
	0 ... 1.0	3	200	71						
	0 ... 1.6	4.8	200	73						
	0 ... 2.5	7.5	200	75						
	0 ... 4	12	200	76						
	0 ... 6	18	200	77						
	0 ... 10	30	200	78						
	0 ... 16	48	200	79						
	0 ... 25	75	200	80						
Sensor	Type 05, accuracy NLH: $\pm 0.5\%$ FS ²⁾				P5					
	Type 02, accuracy NLH: $\pm 0.25\%$ FS ²⁾				P2					
	Type 01, accuracy NLH: $\pm 0.1\%$ FS ²⁾				P1					
Pressure connection	Open					40				
	Closed					41				
	G1/4" male					15				
Electrical Connection	Cable PUR ³⁾						22			
	Cable Teflon ³⁾						32			
	Cable PE ³⁾						29			
Output	4 ... 20 mA							19		
	4 ... 20 mA with lightning protection (Surge)							09		
	0 ... 10 VDC							17		
Accessories	Detachable cable ⁴⁾									37
	Special oil filling Aseol ⁴⁾									94
	Special oil filling Halocarbon ⁴⁾									95
	Electronics packed in gel ⁴⁾									96
	Application for seawater ⁴⁾									97

¹⁾ Customized pressure ranges upon request

²⁾ Accuracy NLH see table

³⁾ Please specify the cable length when ordering

⁴⁾ Please specify the measuring medium when ordering

Standard products (extra short lead time)

Product No.	Type Code	Pressure range [bar]	Over pressure max. [bar]	Supply [VDC]	Accuracy @ 25°C typ. [%]
NAL0.1A	8838	0...0.1	3	9...33	± 0.5
NAL0.2A	8838	0...0.2	3	9...33	± 0.5
NAL1.0A	8838	0...1.0	3	9...33	± 0.5

Specifications		
Electrical Data	Output / supply voltage	4...20 mA: 9...33 VDC 0...10 VDC: 15...30 VDC
	Load	4...20 mA: $R_L \leq (U_s - 9V)/20 \text{ mA}$ 0...10 VDC: $R_L > 10 \text{ k}\Omega$
	Rise time	typ. 1 ms/10...90% nominal pressure
Environmental Conditions	Media temperature	-5°C ... +50°C
	Ambient temperature	-5°C ... +50°C
	Protection	Min. IP68
	Humidity	Max. 95% relative
	Vibration	6g (25...2000 Hz)
	Shock	50g/ 11 ms
EMC Protection	Emission	EN/IEC 61000-6-3
	Immunity	EN/IEC 61000-6-2
Mechanical Data	Sensor	1.4435 (AISI316L)
	Housing / Pressure connection	1.4435 (AISI316L) or titanium
	Sealing	FKM
	Male electrical plug	See ordering information
	Weight	~ 220 g
	Mounting torque	25 Nm

Accuracy				
Range	[bar]	0.1 ... 0.5	0.5 ... 2	2 ... 25
NLH (BSL through 0)				
P5		±0.5	±0.5	±0.5
P2	[% FS]	±0.25	±0.25	±0.25
P1			±0.1	±0.1
Temperature coefficient				
Zero point -5 ... +50°C	[% FS/K]	±0.06	±0.03	±0.015
Span -5 ... +50°C		±0.015	±0.015	±0.015
Long term drift (1 year)	[mbar]	< 4	< 4	< 4

Dimensions

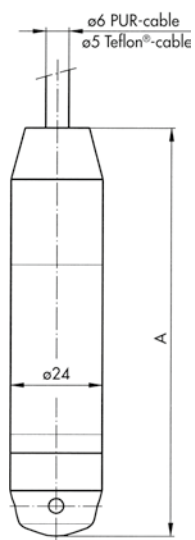

8838.XX.XX.41.XX.XX.XX

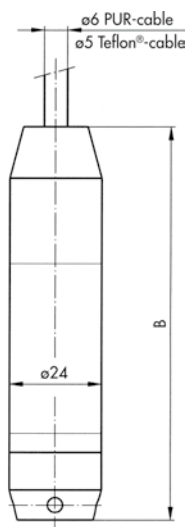

8838.XX.XX.40.XX.XX.XX

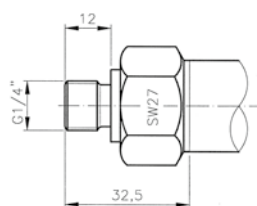

8838.XX.XX.15.XX.XX.XX

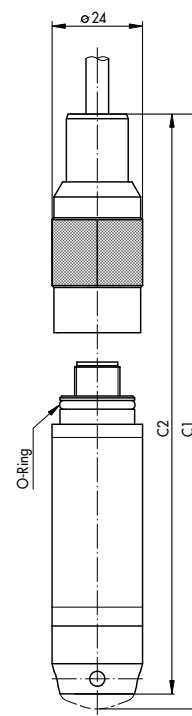

8838.XX.XX.XX.XX.XX.37

	A [mm]	B [mm]	C1 [mm]	C2 [mm]
Standard	108	104	135	131
With lightning protection	157	153	184	180

Electrical Connection

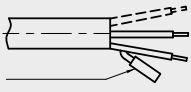
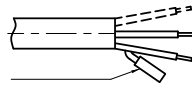
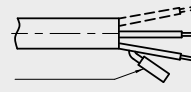
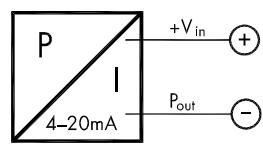
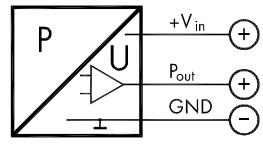
				Protection / electrical connection		
				Min. IP68	Min. IP68	Min. IP68
				Cable PUR	Cable Teflon	Cable PE
				22	32	29
						
				Venting	Venting	Venting
Output signal	 <p>8838.xx.xxxx.xx.19</p>	white	white	white	yellow	yellow
	 <p>8838.xx.xxxx.xx.17</p>	white	white	white	brown	brown

Any manipulation on the ventilation tube will result in warranty loss

Additional information

Documents

Data sheet	www.trafag.com/H72228
Instructions	www.trafag.com/
Flyer	www.trafag.com/H70681

ELECTRONIC PRESSURE SWITCH

Swiss based Trafag is a leading international supplier of high quality sensors and monitoring instruments for measurement of pressure and temperature. The Electronic Pressure Switch EPN-S is based on the well-proven EPN transmitter family. It stands for reliable accuracy over a wide temperature range and excellent long-term stability even in harshest environments in the shipbuilding and railway industry. The switchpoint is factory set or can be programmed on site using Trafag's Sensor Communicator SC.



Applications

- Shipbuilding
- Engine manufacturing
- Railways
- Machine tools
- Hydraulics
- HVAC

Features

- Rugged design for harsh environments
- Wide temperature range
- Excellent long-term stability
- Very compact design
- Switchpoint factory set or programmable on site with Trafag Sensor Communicator SC

Technical Data			
Measuring principle	Thin film on steel	Media temperature	-40°C ... +125°C
Measuring range	0 ... 2.5 to 0 ... 600 bar 0 ... 30 to 0 ... 7500 psi	Ambient temperature	Standard: -25°C ... +85°C Option accessory 67: -40°C ... +125°C
Output signal	Transistor (open source)	Approval / conformity	DNV-GL
Accuracy @ 25°C typ.	± 0.5 % FS typ. (Switchpoint)		

Subject to change

Ordering information/type code

Measuring range ¹⁾	Pressure measurement range [bar]	Over pressure [bar]	Burst pressure [bar]		Pressure measurement range [psi]	Over pressure [psi]	Burst pressure [psi]		8320 . XX	XX	XX	XX	XX	XX
		0 ... 2.5	5	100	75	0 ... 30	30	720	G5					
	0 ... 4	8	100	76	0 ... 50	115	860	G6						
	0 ... 6	12	100	77	0 ... 100	170	1450	G7						
	0 ... 10	20	200	78	0 ... 150	290	2900	G8						
	0 ... 16	32	200	79	0 ... 250	464	2900	G9						
	0 ... 25	50	300	80	0 ... 400	725	4350	H0						
	0 ... 40	80	300	81	0 ... 500	1160	4350	H1						
	0 ... 60	120	500	82	0 ... 1000	1740	5800	H2						
	0 ... 100	200	500	83	0 ... 1500	2900	7250	H3						
	0 ... 160	320	1000	85	0 ... 2000	4640	10850	H5						
	0 ... 250	500	1000	74	0 ... 3000	7250	14500	G4						
	0 ... 400	800	1500	84	0 ... 5000	11600	21750	H4						
	0 ... 600	1000	2000	86	0 ... 7500	14500	29000	H6						
Sensor	Relative pressure													23
Pressure connection	G1/4" male (Seal)													17
	1/4" NPT male													30
	G1/2" male (DIN3852-A) ²⁾													21
	M14x1.5 male (DIN3852-A) ²⁾													22
	1/2" NPT male ²⁾													51
Electrical connection	Male electrical plug: EN 175301-803-A (DIN43650-A)													04
	Cable with shield: Material: FDR 25 (Raychem) 4 x 0.5mm ² , -40°C ... +125°C, (Cable length see "Accessories")													78
	Cable with shield: Material: Radox Tenuis-TW 600V MM S (EN45545), 4 x 0.5mm ² , -40°C ... +120°C, (Cable length see "Accessories")													88
Output signal	1 Transistor out: switchpoint "ON": ... (bar); switchpoint "OFF": ... (bar); delay time: standard 5 (ms), ... (ms) range: 5...10000 (ms)													T1
Accessories	Pressure peak damping element ø 0.4 mm													44
	Pressure peak damping element ø 1.0 mm													40
	Female electrical connector EN 175301-803-A (DIN43650-A)/NBR, -40°C ... +90°C													58
	🚂 Railways version (500 VAC/DC), with shielded cable only													11
	Higher operating temperature: -40°C ... +125°C													67
	Cable length 1.5 m													1M
	Cable length 3.0 m													3M
	Cable length 5.0 m													5M

¹⁾ Customized pressure ranges upon request

²⁾ Please ask us

Programming device Sensor Communicator SC



Ordering No.

- Sensor Communicator SC: F88030
- Programming cable with connector EN 175301-803A: F88049

Manual see

- Sensor Communicator SC: www.trafag.com/H73699 (EN) and www.trafag.com/H73698 (DE)



Specifications		
Accuracy	Accuracy @ 25°C typ.	± 0.5 % FS typ. (Switchpoint)
	Temperature dependence switching point	Switchpoint @ +25°C: ± 0.5 % FS typ. Switchpoint @ -25°C ... +85°C: ± 1.0 % FS typ. Switchpoint @ -40°C ... +125°C: ± 1.3 % FS typ. (Accessory 67: higher operating temperature -40°C ... +125°C)
	Long term stability 1 year typ.	≤ ± 0.15 % FS typ.
Electrical Data	Supply voltage	24 (9 ... 32) VDC
	Resistance of insulation	> 10 MΩ, 250 VDC  > 10 MΩ, 500 VDC
	Dielectric strength	250 VAC, 50 Hz  500 VAC, 50 Hz
	Output / supply voltage	Transistor (open source): 24 (9 ... 32) VDC
	Inverse-polarity protection, short-circuit strength @ 25°C during 5 min.	integrated
	Current consumption	≤ 15 mA
	Environmental conditions	Media temperature
Ambient temperature		Standard: -25°C ... +85°C Option accessory 67: -40°C ... +125°C
Protection		Electrical connection 04: IP65 (IP67) Electrical connection 78/88: IP69K
Humidity		Max. 95 % relative
Vibration		15 g (50...2000 Hz)
Shock		50 g / 11 ms
EMC Protection		Emission
	Immunity	EN/IEC 61000-6-2
Mechanical Data	Sensor (wetted parts)	1.4542 (AISI630)
	Pressure connection (wetted parts)	Pressure ranges ≤ 250 bar: 1.4542 (AISI630) Pressure ranges > 250 bar: 1.4301 (AISI304)
	Housing	1.4301 (AISI304)
	Sealing	FKM 70 Sh
	Male electrical plug	See ordering information
	Weight	~ 85 ... 110 g
	Mounting torque	25 Nm

Switching output

Output signal	1 Transistor (open source)
Switchpoint setting	Switchpoint factory set or programmable on site with Trafag Sensor Communicator SC
Adjustment range	0 ... 100 % FS
Switching hysteresis	$\geq 1\%$ FS
Switching current	$\leq 0.5\text{ A}$ @ $-40^\circ\text{C} \dots +85^\circ\text{C}$ $\leq 0.4\text{ A}$ @ $+85^\circ\text{C} \dots +125^\circ\text{C}$ (only with accessory 67: higher operating temperature $-40^\circ\text{C} \dots +125^\circ\text{C}$)
Switching resistance	$\leq 3\Omega$
Delay time	Standard adjustment: 5 ms Adjustable with Trafag Sensor Communicator (only electrical connection 04): 5 ms ... 10 s

Dimensions

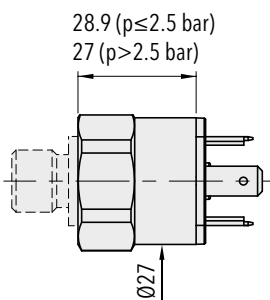

8320.XX.XXXX.04.XX.XX

Switchpoint factory set or programmable on site with Trafag Sensor Communicator SC

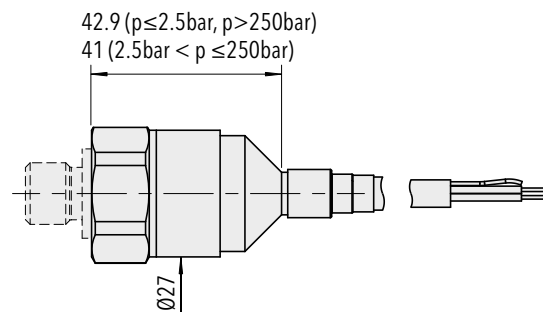

8320.XX.XXXX.78.XX.XX

Switchpoint factory set

8320.XX.XXXX.88.XX.XX

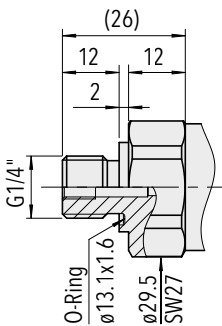

8320.XX.XX17.XX.XX.XX

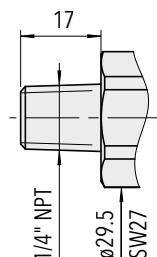

8320.XX.XX30.XX.XX.XX

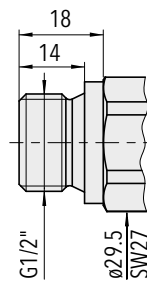

8320.XX.XX21.XX.XX.XX

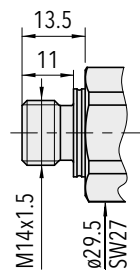

8320.XX.XX22.XX.XX.XX

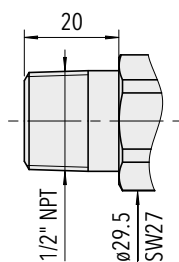

8320.XX.XX51.XX.XX.XX

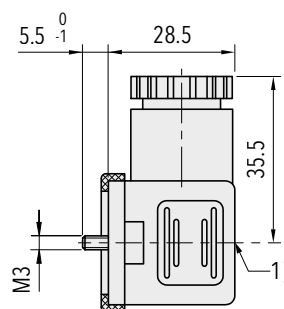

1) Tightening torque 50...60Ncm

8320.XX.XXXX.XX.XX.58

Electrical Connection

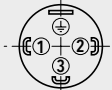
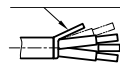
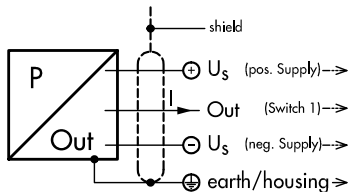
		Protection / electrical connection	
		IP65 (IP67)	IP69K
		Industrial standard EN175301-803A 04 	Cable **) 78/88 Shield 
Output signal		1	brown
		2	blue
		3	black
		⊕	yellow / green
8320.XX.XXXX.XX.T1			

***) Ventilation via cable end

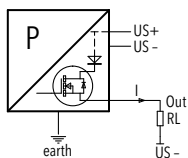

Connection of loads to switch contacts

Additional information

Documents

Data sheet	www.trafag.com/H72333
Instructions	www.trafag.com/H73333
Flyer	www.trafag.com/H70652

DISPLAY PRESSURE SWITCH

Swiss based Trafag is a leading international supplier of high quality sensors and monitoring instruments for measurement of pressure and temperature. The DPC 8380 is the ideal combination of pressure switch and transmitter with pressure display. The parameters are set on the device or in a timesaving way via an NFC - smartphone App. The settings in combination with a comprehensive set of options make the DPC 8380 suitable for a wide range of industrial applications.



Applications

- Machine tools
- HVAC
- Refrigeration
- Water treatment
- Process technology

Features

- Parametrisation also via NFC-smartphone App (Android)
- Display and electrical connection are independently rotatable 335°/343°
- Analogue output switchable mA or V
- Integrated datalogger
- Pressure range adjustable, 50 ... 100 % of the nominal range

Technical Data

Measuring principle	Thick film on ceramic	Media temperature	-25°C ... +85°C
Measuring range	0 ... 0.2 to 0 ... 100 bar 0 ... 2.5 to 0 ... 1500 psi adjustable 50 ... 100 % FS	Ambient temperature	-25°C ... +85°C
Output signal	4 ... 20 mA, 0 ... 5 VDC, 1 ... 6 VDC, 0 ... 10 VDC, switchable mA or V	Pressure unit for display	bar, psi, MPa, kPa, m WC, mm WC
Switching output	2 transistors PNP	Logger	Ring buffer: 3518 data points Sampling time: 0.1 ... 999.9 s, Off (0)
Accuracy @ 25°C typ.	± 0.5 % FS typ.		

Subject to change

Ordering information/type code

				8380 . XX	XX	XX	XX	XX	XX	
Measuring range ¹⁾	Pressure measurement range [bar]	Over pressure [bar]	Burst pressure [bar]							
	0 ... 0.2	1.2	2	68	0 ... 2.5	15	30	F8		
	0 ... 0.4	1.2	2	69	0 ... 5	15	30	F9		
	0 ... 0.6	2	3	70	0 ... 7.5	30	45	G0		
	0 ... 1	2	4.8	71	0 ... 15	45	70	G1		
	0 ... 1.6	3.2	4.8	73	0 ... 20	45	70	G3		
	0 ... 2.5	5	7.5	75	0 ... 30	60	90	G5		
	0 ... 4	8	12	76	0 ... 50	100	150	G6		
	0 ... 6	12	15	77	0 ... 100	200	250	G7		
	0 ... 10	20	25	78	0 ... 150	300	375	G8		
	0 ... 16	32	40	79	0 ... 250	500	625	G9		
	0 ... 25	50	75	80	0 ... 400	800	1200	H0		
	0 ... 40	80	100	81	0 ... 500	1000	1250	H1		
	0 ... 60	120	180	82	0 ... 1000	2000	3000	H2		
	0 ... 100	200	300	83	0 ... 1500	3000	4500	H3		
	Sensor	Relative pressure, 1.4305, accuracy: 0.5 %			57	Absolute pressure, 1.4305, accuracy: 0.5 % ³⁾			87	
Relative pressure, 1.4404/1.4435, accuracy: 0.5 % ⁴⁾			59	Absolute pressure, 1.4404/1.4435, accuracy: 0.5 % ^{3) 4)}			89			
Relative pressure, 1.4462, accuracy: 0.5 % ⁴⁾			52	Absolute pressure, 1.4462, accuracy: 0.5 % ^{3) 4)}			82			
Relative pressure, titanium grade 5, accuracy: 0.5 % ⁴⁾			53	Absolute pressure, Titanium Grade 5, accuracy: 0.5 % ^{3) 4)}			83			
Pressure connection	G1/4" female		10	7/16"-20UNF male, DIN3866 ⁴⁾			18			
	G1/4" male		17	7/16"-20UNF female SAE J512 with valve opener ⁴⁾			24			
	G1/2" male DIN3852-E ⁴⁾		41	7/16"-20UNF female SAE4 ⁴⁾			42			
	1/4" NPT male ⁴⁾		30	G3/4" frontal membrane ^{4) 6)}			52			
	R1/4" male, DIN3858 ⁴⁾		19							
Electrical connection	Male electrical plug M12x1, 4-pole, Mat. PA (Accessories P3, P4)						32			
	Male electrical plug M12x1, 5-pole, Mat. PA (Accessories P1, P2)						35			
Output signal	Switching output PNP, current output 4 ... 20 mA; output detail see accessories P1, P2, P3							PA		
	Switching output PNP, voltage output 1 ... 6 VDC; output detail see accessories P1, P2, P3							PU		
	Switching output PNP, voltage output 0 ... 10 VDC; output detail see accessories P1, P2, P3							PV		
	Switching output PNP, voltage output 0 ... 5 VDC; output detail see accessories P1, P2, P3							PW		
	Switching output PNP; output detail see accessory P4							PS		
Accessories	Pin configuration 5-pole.; 1: U+, 2: analogue, 3: U-, 4: SP1, 5: SP2							P1		
	Pin configuration 5-pole.; 1: U+, 2: SP2, 3: U-, 4: SP1, 5: analogue							P2		
	Pin configuration 4-pole.; 1: U+, 2: analogue, 3: U-, 4: SP1							P3		
	Pin configuration 4-pole.; 1: U+, 2: SP2, 3: U-, 4: SP1							P4		
	Pressure peak damping element ø 1.0 mm (for pressure connections 17 and 30)							40		
	Pressure peak damping element ø 0.4 mm (for pressure connections 17 and 30)							44		
	Seal FPM, -18°C ... +125°C							61		
	Seal EPDM, -40°C ... +125°C							63		
	Female electrical plug M12x1, 5-pole ⁵⁾							33		
	Parametrisation standard (see table Parameter)							ZS		
	Parametrisation according to customer specifications (see table Parameter)							ZC		

¹⁾ Extended overpressure as well as customized pressure ranges upon request

³⁾ Absolute ranges max. 40 bar

⁴⁾ Please ask us

⁵⁾ For electrical connections 32 and 35

⁶⁾ Not for sensors 57 and 87, only for pressure ranges ≤ 10 bar or 150 psi

Parameter				
Name	Standard adjustment (Accessory ZS)	Value range	Shortname	Customer adjustment (Accessory ZC)
Switch point SP1 (hysteresis mode) Upper switch point FH1 (window mode)	75 % Measuring range	SP1 > RP1 FH1 > FL1 Hysteresis ≥ 1 % d.S.	SP1	
Reset point RP1 (hysteresis mode) Lower switch point FL1 (window mode)	25 % Measuring range	RP1 < SP1 FL1 < FH1 Hysteresis ≥ 1 % d.S.	RP1	
Switch point SP2 (hysteresis mode) Upper switch point FH2 (window mode)	75 % Measuring range	SP2 > RP2 FH2 > FL2 Hysteresis ≥ 1 % d.S.	SP2	
Reset point RP2 (hysteresis mode) Lower switch point FL2 (window mode)	25 % Measuring range	RP2 < SP2 FL2 < FH2 Hysteresis ≥ 1 % d.S.	RP2	
Switch point delay time SP1 (hysteresis mode) Switch point delay time FH1 (window mode)	0	0 ... 99.99 s	dS1	
Switch point delay time RP1 (hysteresis mode) Switch point delay time FL1 (window mode)	0	0 ... 99.99 s	dR1	
Switch point delay time SP2 (hysteresis mode) Switch point delay time FH2 (window mode)	0	0 ... 99.99 s	dS2	
Switch point delay time RP2 (hysteresis mode) Switch point delay time FL2 (window mode)	0	0 ... 99.99 s	dR2	
Function switching output 1	Hysteresis, closer (Hno)	Hysteresis NO (Hno), Hysteresis NC (Hnc) Window NO (Fno), Window NC (Fnc)	ou1	
Function switching output 2	Hysteresis, closer (Hno)	Hysteresis NO (Hno), Hysteresis NC (Hnc) Window NO (Fno), Window NC (Fnc)	ou2	
Pressure unit	bar	bar, psi, MPa, kPa, m WC	uni	
Measuring range adjustment	100 % Nominal pressure	50 ... 100 % Nominal	P-EP	
Damping analogue output	0.01 s	0.01 ... 3.00 s (time constant)	dAA	
Display rotation	No	No, yes (180°)	disr	
Display mode	Current pressure value	Pressure value: current, highest, lowest, display off Current value: decimal places selectable (max. 3)	dis	
Display actualisation	2	1, 2, 5, 20 Hz	duPd	

Specifications		
Electrical Data	Output / supply voltage	4 ... 20 mA: 24 (15 ... 30) VDC 0 ... 5 VDC: 24 (15 ... 30) VDC 1 ... 6 VDC: 24 (15 ... 30) VDC 0 ... 10 VDC: 24 (15 ... 30) VDC
	Switch-on-delay	Typ. 200 ms
	Inverse-polarity protection, short-circuit strength @ 25°C during 5 min.	integrated
	Current consumption	≤ 30 mA
Environmental conditions	Media temperature	-25°C ... +85°C
	Ambient temperature	-25°C ... +85°C
	Protection ¹⁾	IP67
	Humidity	Max. 95 % relative
	Vibration	10 g (10 ... 2000 Hz)
	Shock	50 g / 3 ms
EMC Protection	Emission	EN/IEC 61000-6-3
	Immunity	EN/IEC 61000-6-2
Mechanical Data	Sensor (wetted parts)	Ceramic, Al ₂ O ₃ (96 %)
	Pressure connection (wetted parts)	57/87: 1.4305 (AISI303) 59/89: 1.4404/1.4435 (AISI316L) 52/82: 1.4462 (AISI318LN) 53/83: Titanium Grade 5
	Housing	Zinc based die-casting alloy, nickel plated display housing plastic
	Sealing	FPM, EPDM
	Male electrical plug	See ordering information
	Weight	~ 189 g
	Mounting torque	15 ... 20 Nm
	Housing alignment	Display 335° rotatable, max. 2.5 Nm Electrical connection 343° rotatable, max. 5 Nm

¹⁾ See electrical connection

Measuring accuracy 0.5 %

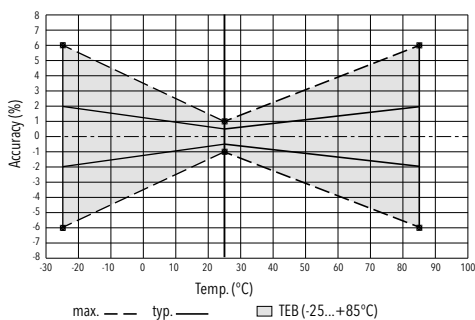

Analogue output

Output signal	Switchable 4 ... 20 mA or voltage		
Accuracy	TEB @ -25 ... +85°C	[% FS typ.]	± 2.0
	Accuracy @ +25°C	[% FS typ.]	± 0.5
	NLH @ +25°C (BSL)	[% FS typ.]	± 0.2
	TC zero point and span	[% FS/K typ.]	± 0.03
	Long term stability 1 year	[% FS typ.]	± 0.3
Current limiting output signal	4 ... 20 mA: 25 mA (overload)		
	0 ... 10 VDC: < 40 mA (short-circuit)		
Damping (rise time)	0.01 ... 3.00 s / 10 ... 90 % Nominal pressure		

Switching output

Accuracy	Accuracy @ +25°C	[% FS typ.]	± 0.5
	TEB @ -25 ... +85°C	[% FS typ.]	± 2.0
	Long term stability 1 year	[% FS typ.]	≤ ± 0.3
Adjustment range of switchpoints	0 ... 100 % FS		
Switching hysteresis	≥ 1 % FS		
	Switchpoint > reset point		
Switching resistance	≤ 3 Ω		
Output function	Hysteresis, Window; normally closed (NO), normally open (NC)		
Switching current	≤ 0.5 A each switching output		
Current limiting	≤ 2 A each switching output		
Switching frequency	max. 200 Hz		
Delay time	0 ... 99.99 s		

Display

Display	4-digit 7-segment display 180° flippable with disable function Standard decimal places: ≤ 9: 3 decimal places 10 ... 99: 2 decimal places 100 ... 999: 1 decimal place
Switching status indication	2 LED, red
Operation	With 3 buttons and menu navigation according to VDMA 24574-1
Display resolution	0.1 % FS
Display range	-3 ... 103 % FS
Setting parameters	See table Parameter

Dimensions

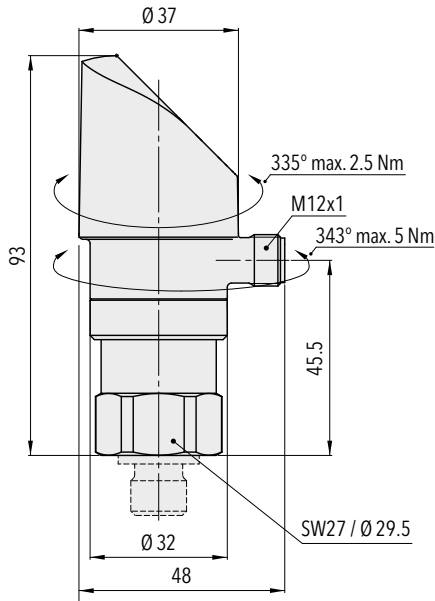

8380.XX.XXXX.35/32.XX.XX

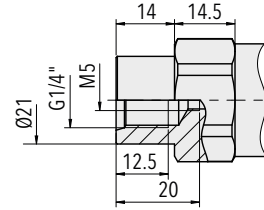

8380.XX.XX10.XX.XX.XX

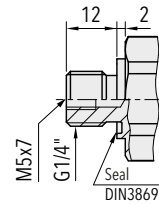

8380.XX.XX17.XX.XX.XX

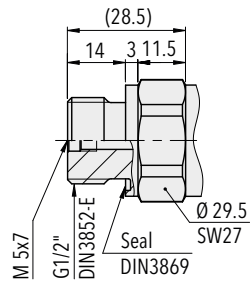

8380.XX.XX41.XX.XX.XX

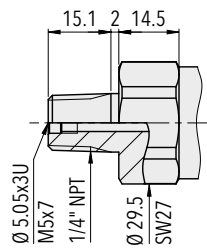

8380.XX.XX30.XX.XX.XX

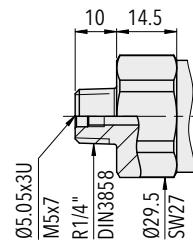

8380.XX.XX19.XX.XX.XX

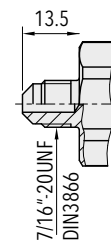

8380.XX.XX18.XX.XX.XX

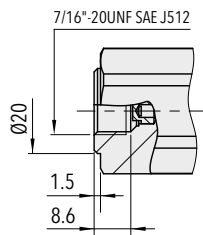

8380.XX.XX24.XX.XX.XX

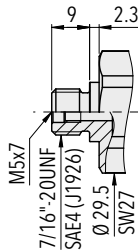

8380.XX.XX42.XX.XX.XX

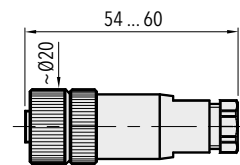

8380.XX.XXXX.XX.XX.33

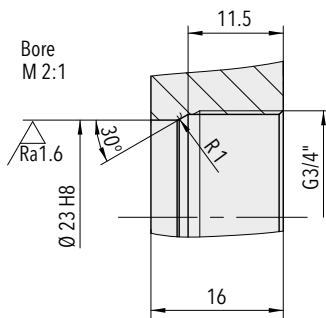

8380.XX.XX52.XX.XX.XX

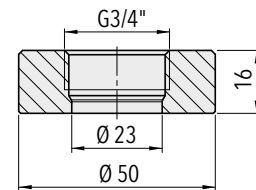
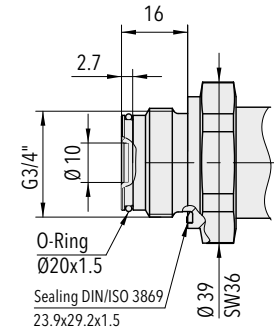

Welding flange for
G3/4" frontal membrane (1.4301)
Ordering No. C27805

Electrical connection

		Protection / electrical connection			
		IP67*)			
		M12x1			
		5-pole4-pole			
		35		32	
Output signal		P1	P2	P3	P4
	PA	✓	✓	✓	
	PU	✓	✓	✓	
	PV	✓	✓	✓	
	PW	✓	✓	✓	
	PS				✓
Pin Configuration		P1	P2	P3	P4
	<p>8380.xx.xxxx.xx.PA/PU/PV/PW/PS</p>	1 3 2 4 5 Shield ***)	1 3 5 4 2 Shield ***)	1 3 2 4 Shield ***)	1 3 - 4 2

Connection of loads to switching output

*) Provided female connector is mounted according to instructions
 ***) The use of a shielded cable is recommended

Functions switching output

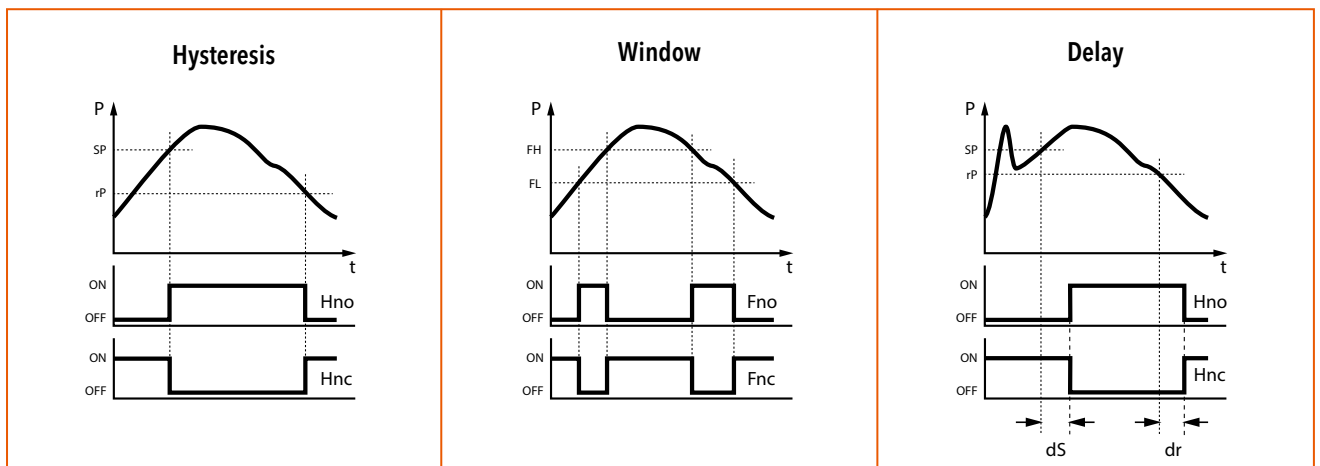

Additional information		
Documents	Data sheet	www.trafag.com/H72320
	Instructions	www.trafag.com/H73320
	Flyer	www.trafag.com/H70691

DISPLAY PRESSURE SWITCH

Swiss based Trafag is a leading international supplier of high quality sensors and monitoring instruments for measurement of pressure and temperature. The DPC 8381 is the ideal combination of pressure switch and transmitter with a pressure display. The parameters are set on the device or in a timesaving way via an NFC - smartphone App. The settings in combination with a comprehensive set of options make the DPS 8381 suitable for a wide range of demanding applications.



Applications

- Machine tools
- Hydraulics
- Process technology
- Industrial applications

Features

- Parametrisation also via NFC-smartphone App (Android)
- Display and electrical connection are independently rotatable 335°/343°
- Analogue output switchable mA or V
- Integrated datalogger
- Pressure range adjustable, 50 ... 100 % of the nominal range

Technical Data

Measuring principle	Thin film on steel	Media temperature	-25°C ... +85°C
Measuring range	0 ... 2.5 to 0 ... 600 bar 0 ... 30 to 0 ... 7500 psi adjustable 50 ... 100 % FS	Ambient temperature	-25°C ... +85°C
Output signal	4 ... 20 mA, 0 ... 5 VDC, 1 ... 6 VDC, 0 ... 10 VDC, switchable mA or V	Pressure unit for display	bar, psi, MPa, kPa, m WC, mm WC
Switching output	2 transistors PNP	Logger	Ring buffer: 3518 data points Sampling time: 0.1 ... 999.9 s, Off (0)
Accuracy @ 25°C typ.	± 0.5 % FS typ.		

Subject to change

Ordering information/type code

							8381 . XX	XX	XX	XX	XX	XX
Measuring range ¹⁾	Pressure measurement range [bar]	Over pressure [bar]	Burst pressure [bar]		Pressure measurement range [psi]	Over pressure [psi]	Burst pressure [psi]					
	0 ... 2.5	7.5	50	75	0 ... 30	90	700	G5				
	0 ... 4	12	60	76	0 ... 50	150	850	G6				
	0 ... 6	18	100	77	0 ... 100	300	1450	G7				
	0 ... 10	30	200	78	0 ... 150	450	2500	G8				
	0 ... 16	48	200	79	0 ... 200	600	2500	GA				
	0 ... 25	75	300	80	0 ... 250	750	2500	G9				
	0 ... 40	120	300	81	0 ... 300	900	4000	HA				
	0 ... 60	180	400	82	0 ... 400	1200	4000	H0				
	0 ... 100	300	500	83	0 ... 500	1500	4000	H1				
	0 ... 160	480	750	85	0 ... 1000	3000	5000	H2				
	0 ... 250	750	1000	74	0 ... 1500	4500	7000	H3				
	0 ... 400	1000	2000	84	0 ... 2000	6000	10000	H5				
	0 ... 600	1500	2500	86	0 ... 3000	9000	14500	G4				
					0 ... 5000	12500	21750	H4				
					0 ... 7500	18750	29000	H6				
	Sensor	Relative pressure, accuracy: 0.5 %								25		
Pressure connection	G1/4" female ²⁾		10		1/2" NPT male ²⁾			51				
	G1/4" male (Seal)		17		M14x1.5 male DIN6149-2 ²⁾			31				
	R1/4" male, DIN3858 ²⁾		19		7/16"-20UNF male, DIN3866 ^{2) 4)}			18				
	G1/2" male (Manometer) ²⁾		11		7/16"-20UNF male SAE4 (J1926) ^{2) 5)}			42				
	1/4" NPT male ²⁾		30		7/16"-20UNF female SAE J512 with valve opener ^{2) 4)}			24				
Electrical connection	Male electrical plug M12x1, 4-pole, Mat. PA (Accessories P3, P4)								32			
	Male electrical plug M12x1, 5-pole, Mat. PA (Accessories P1, P2)								35			
Output signal	Switching output PNP, current output 4 ... 20 mA; output detail see accessories P1, P2, P3											PA
	Switching output PNP, voltage output 1 ... 6 VDC; output detail see accessories P1, P2, P3											PU
	Switching output PNP, voltage output 0 ... 10 VDC; output detail see accessories P1, P2, P3											PV
	Switching output PNP, voltage output 0 ... 5 VDC; output detail see accessories P1, P2, P3											PW
	Switching output PNP; output detail see accessory P4											PS
Accessories	Pin configuration 5-pole.; 1: U+, 2: analogue, 3: U-, 4: SP1, 5: SP2											P1
	Pin configuration 5-pole.; 1: U+, 2: SP2, 3: U-, 4: SP1, 5: analogue											P2
	Pin configuration 4-pole.; 1: U+, 2: analogue, 3: U-, 4: SP1											P3
	Pin configuration 4-pole.; 1: U+, 2: SP2, 3: U-, 4: SP1											P4
	Pressure peak damping element ø 1.0 mm (for pressure connections 17 and 30)											40
	Pressure peak damping element ø 0.4 mm (for pressure connections 17 and 30)											44
	Seal FPM, -18°C ... +125°C											61
	Seal EPDM, -40°C ... +125°C											63
	Seal NBR, -25°C ... +100°C											83
	Female electrical plug M12x1, 5-pole ³⁾											33
	Parametrisation standard (see table Parameter)											ZS
	Parametrisation according to customer specifications (see table Parameter)											ZC

¹⁾ Extended overpressure as well as customized pressure ranges upon request

²⁾ Upon request

³⁾ For electrical connections 32 and 35

⁴⁾ Max. allowable pressure range 60 bar at 120 bar overpressure

⁵⁾ According to norm J1926, max. 35 MPa

Parameter				
Name	Standard setting (accessory ZS)	Value range	Short name	Customer adjustment (accessory ZC)
Switch point SP1 (hysteresis mode) Upper switch point FH1 (window mode)	75 % Measuring range	SP1 > RP1 FH1 > FL1 Hysteresis ≥ 1 % FS	SP1	
Reset point RP1 (hysteresis mode) Lower switch point FL1 (window mode)	25 % Measuring range	RP1 < SP1 FL1 < FH1 Hysteresis ≥ 1 % FS	RP1	
Switch point SP2 (hysteresis mode) Upper switch point FH2 (window mode)	75 % Measuring range	SP2 > RP2 FH2 > FL2 Hysteresis ≥ 1 % FS	SP2	
Reset point RP2 (hysteresis mode) Lower switch point FL2 (window mode)	25 % Measuring range	RP2 < SP2 FL2 < FH2 Hysteresis ≥ 1 % FS	RP2	
Switch point delay time SP1 (hysteresis mode) Switch point delay time FH1 (window mode)	0	0 ... 99.99 s	dS1	
Switch point delay time RP1 (hysteresis mode) Switch point delay time FL1 (window mode)	0	0 ... 99.99 s	dR1	
Switch point delay time SP2 (hysteresis mode) Switch point delay time FH2 (window mode)	0	0 ... 99.99 s	dS2	
Switch point delay time RP2 (hysteresis mode) Switch point delay time FL2 (window mode)	0	0 ... 99.99 s	dR2	
Functions switching output 1	Hysteresis, closer (Hno)	Hysteresis NO (Hno), Hysteresis NC (Hnc) Window NO (Fno), Window NC (Fnc)	ou1	
Functions switching output 2	Hysteresis, closer (Hno)	Hysteresis NO (Hno), Hysteresis NC (Hnc) Window NO (Fno), Window NC (Fnc)	ou2	
Pressure units	bar	bar, psi, MPa, kPa, m WC	uni	
Measuring range adjustment	100 % Nominal pressure	50 ... 100 % Nominal	P-EP	
Damping (analogue output)	0.01 s	0.01 ... 3.00 s (time constant)	dAA	
Display rotation	No	no, yes (180°)	disr	
Display mode	Current pressure value	Pressure value: current, highest, lowest, display off Current value: decimal places selectable (max. 3)	dis	
Display actualisation	2	1, 2, 5, 20 Hz	duPd	

Specifications		
Electrical Data	Output / supply voltage	4 ... 20 mA: 24 (15 ... 30) VDC 0 ... 5 VDC: 24 (15 ... 30) VDC 1 ... 6 VDC: 24 (15 ... 30) VDC 0 ... 10 VDC: 24 (15 ... 30) VDC
	Switch-on-delay	Typ. 200 ms
	Inverse-polarity protection, short-circuit strength @ 25°C during 5 min.	integrated
	Current consumption	≤ 30 mA
Environmental conditions	Media temperature	-25°C ... +85°C
	Ambient temperature	-25°C ... +85°C
	Protection ¹⁾	IP67
	Humidity	Max. 95 % relative
	Vibration	10 g (10 ... 2000 Hz)
	Shock	50 g / 3 ms
EMC Protection	Emission	EN/IEC 61000-6-3
	Immunity	EN/IEC 61000-6-2
Mechanical Data	Sensor (wetted parts)	1.4542 (AISI630)
	Pressure connection (wetted parts)	1.4542 (AISI630)
	Housing	Zinc based die-casting alloy, nickel plated display housing plastic
	Sealing	FPM, NBR, EPDM
	Male electrical plug	See ordering information
	Weight	~ 189 g
	Mounting torque	15 ... 20 Nm
	Housing alignment	Display 335° rotatable, max. 2.5 Nm Electrical connection 343° rotatable, max. 5 Nm

¹⁾ See electrical connection

Measuring accuracy 0.5 %

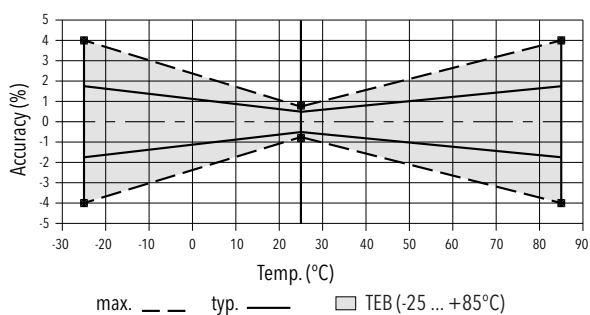

Analogue output

Output signal	Switchable 4 ... 20 mA or voltage		
Accuracy	TEB @ -25 ... +85°C	[% FS typ.]	± 1.75
	Accuracy @ +25°C	[% FS typ.]	± 0.5
	NLH @ +25°C (BSL)	[% FS typ.]	± 0.2
	TC zero point and span	[% FS/K typ.]	± 0.03
	Long term stability 1 year	[% FS typ.]	± 0.1
Current limiting output signal	4 ... 20 mA: 25 mA (overload)		
	0 ... 10 VDC: < 40 mA (short-circuit)		
Damping (rise time)	0.01 ... 3.00 s / 10 ... 90 % Nominal pressure		

Switching output

Accuracy	Accuracy @ +25°C	[% FS typ.]	± 0.5
	TEB @ -25 ... +85°C	[% FS typ.]	± 1.0
	Long term stability 1 year	[% FS typ.]	≤ ± 0.3
Adjustment range of switchpoints	0 ... 100 % FS		
Switching hysteresis	≥ 1 % FS		
	Switchpoint > reset point		
Switching resistance	≤ 3 Ω		
Output function	Hysteresis, Window; normally closed (NO), normally open (NC)		
Switching current	≤ 0.5 A each switching output		
Current limiting	≤ 2 A each switching output		
Switching frequency	max. 200 Hz		
Delay time	0 ... 99.99 s		

Display

Display	4-digit 7-segment display 180° flippable with disable function Standard decimal places: ≤ 9: 3 decimal places 10 ... 99: 2 decimal places 100 ... 999: 1 decimal place
Switching status indication	2 LED, red
Operation	With 3 buttons and menu navigation according to VDMA 24574-1
Display resolution	0.1 % FS
Display range	-3 ... 103 % FS
Setting parameters	See table Parameter

Dimensions

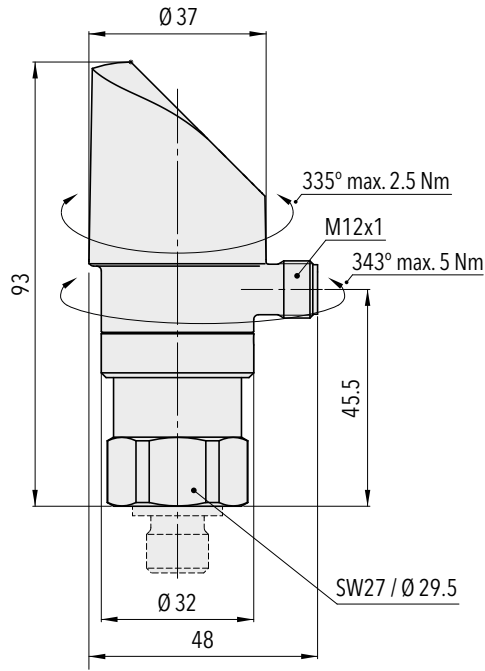

8381.XX.XXXX.35/32.XX.XX

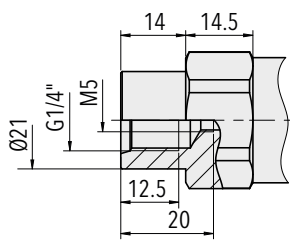

8381.XX.XX10.XX.XX.XX

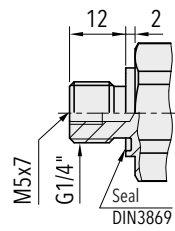

8381.XX.XX17.XX.XX.XX

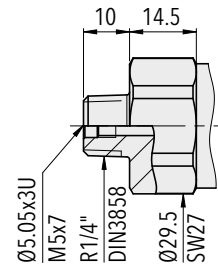

8381.XX.XX19.XX.XX.XX

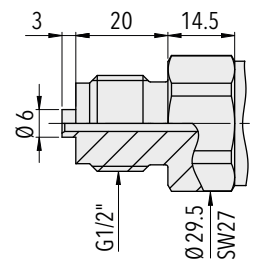

8381.XX.XX11.XX.XX.XX

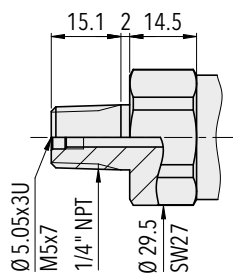

8381.XX.XX30.XX.XX.XX

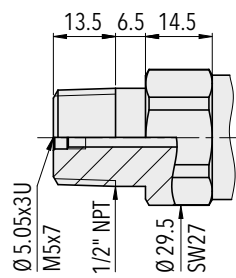

8381.XX.XX51.XX.XX.XX

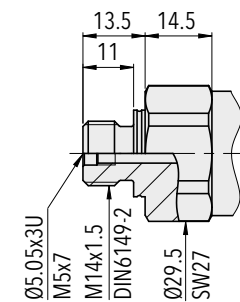

8381.XX.XX31.XX.XX.XX

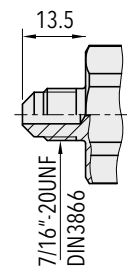

8381.XX.XX18.XX.XX.XX

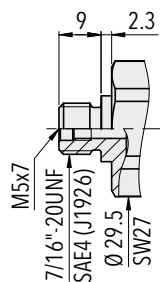

8381.XX.XX42.XX.XX.XX

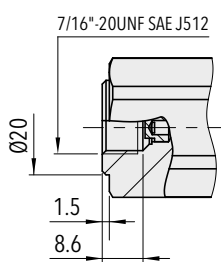

8381.XX.XX24.XX.XX.XX

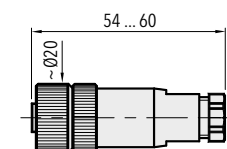

8381.XX.XXXX.XX.XX.33

Electrical connection

		Protection / electrical connection			
		IP67*)			
		M12x1			
		5-pole4-pole			
		35		32	
Output signal		P1	P2	P3	P4
	PA	✓	✓	✓	
	PU	✓	✓	✓	
	PV	✓	✓	✓	
	PW	✓	✓	✓	
	PS				✓
Pin Configuration		P1	P2	P3	P4
		1 3 2 4 5 Shield ***	1 3 5 4 2 Shield ***	1 3 2 4 Shield ***	1 3 - 4 2 Shield ***

Connection of loads to switching output

*) Provided female connector is mounted according to instructions

***) The use of a shielded cable is recommended

Functions switching output

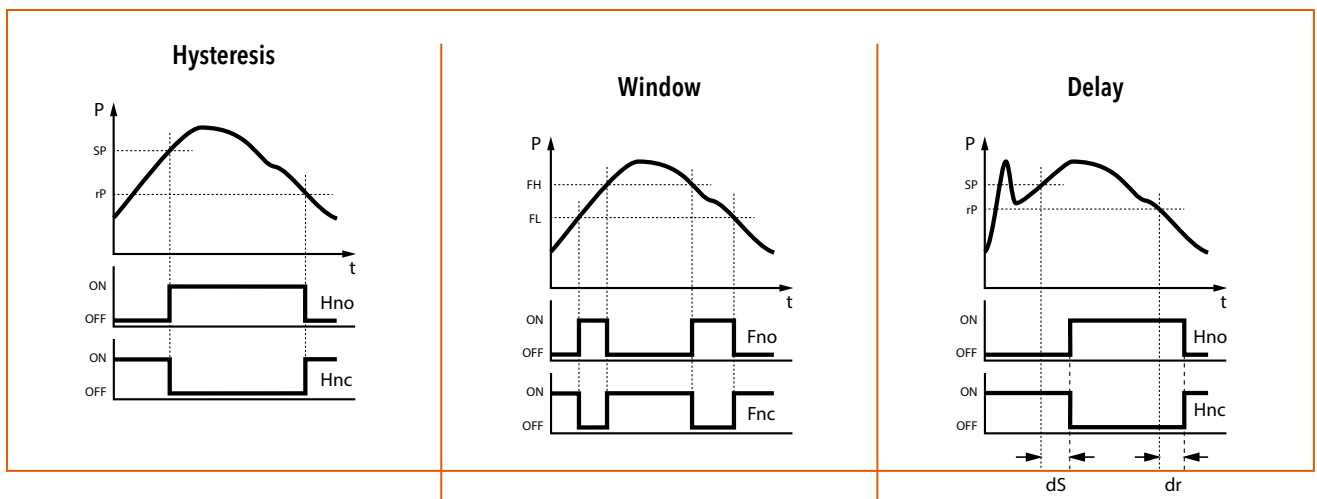

Additional information		
Documents	Data sheet	www.trafag.com/H72321
	Instructions	www.trafag.com/H73320
	Flyer	www.trafag.com/H70694

DISPLAY CONTROL SWITCH

Swiss based Trafag is a leading international supplier of high quality sensors and monitoring instruments for measurement of pressure and temperature.



Applications

- Shipbuilding
- Machine tools
- Hydraulics
- Process technology



Features

- Simple adjustment of switchpoints
- Back-lit LCD-Display
- Measurement and indication of pressure (incl. switch state) and sensor temperature in various units
- High resistance to pressure cycling
- Output signal 2 relays, electrically isolated

Technical Data			
Measuring principle	Thin film on steel	Media temperature	-25°C ... +125°C
Measuring range	0 ... 1 to 0 ... 600 bar	Ambient temperature	-25°C ... +80°C (LCD display active -10°C ... +70°C)
Output signal	4 ... 20 mA, 0 ... 10 VDC 2 Relays, electrically isolated 30W (max. 1A), 36 VAC/ DC	Approval / conformity	DNV-GL
Accuracy @ 25°C typ.	± 0.5 % FS typ.		

Subject to change

Ordering information/type code

				8864 . XX	XX	XX	XX	XX	XX
Measuring range ¹⁾	Pressure measurement range	Over pressure	Burst pressure						
	[bar]	[bar]	[bar]						
	0 ... 1	2	30	71					
	0 ... 2.5	5	100	75					
	0 ... 4	8	100	76					
	0 ... 6	12	100	77					
	0 ... 10	20	200	78					
	0 ... 16	32	200	79					
	0 ... 25	50	300	80					
	0 ... 40	80	300	81					
	0 ... 60	120	500	82					
	0 ... 100	200	500	83					
	0 ... 250	500	1000	74					
	0 ... 400	800	1500	84					
0 ... 600	1200	2000	86						
Sensor	Relative pressure				23				
Pressure connection	G1/4" male (Seal DIN3869 and pressure peak damping element)				15				
	G1/4" male (seal DIN3869)				17				
	G1/4" female				10				
	G1/2" male DIN16288-B (Manometer)				11				
	Flange connection				41				
Electrical connection	Male electrical plug M12x1, 8-pole					38			
Output	Signal output	Load resistance	U (supply)						
	4 ... 20 mA	≤ 250 W	11 ... 32 VDC				19		
	0 ... 10 VDC	≥ 5.0 kW	15 ... 30 VDC				17		
Accessories	2 Relays								23
	Female electrical connector: M12x1, 8-pole, incl. 2m PUR-cable								
	Ordering code: DCS CON								

¹⁾ Customized pressure ranges upon request

Standard products (extra short lead time)

Product No.	Type Code	Pressure range [bar]	Over pressure max. [bar]	Signal output	Accuracy @ 25°C typ. [%]
DCS2.5AR	8864 75 2315 38 0000 0000 19 23	0...2.5	6	4...20 mA; 2 relays 30 W (max. 1 A)/36 VAC/DC	±0.5
DCS4.0AR	8864 76 2315 38 0000 0000 19 23	0...4	10	4...20 mA; 2 relays 30 W (max. 1 A)/36 VAC/DC	±0.5
DCS6.0AR	8864 77 2315 38 0000 0000 19 23	0...6	15	4...20 mA; 2 relays 30 W (max. 1 A)/36 VAC/DC	±0.5
DCS10.0AR	8864 78 2315 38 0000 0000 19 23	0...10	20	4...20 mA; 2 relays 30 W (max. 1 A)/36 VAC/DC	±0.5
DCS16.0AR	8864 79 2315 38 0000 0000 19 23	0...16	32	4...20 mA; 2 relays 30 W (max. 1 A)/36 VAC/DC	±0.5
DCS25.0AR	8864 80 2315 38 0000 0000 19 23	0...25	80	4...20 mA; 2 relays 30 W (max. 1 A)/36 VAC/DC	±0.5
DCS40.0AR	8864 81 2315 38 0000 0000 19 23	0...40	80	4...20 mA; 2 relays 30 W (max. 1 A)/36 VAC/DC	±0.5
DCS100.0AR	8864 83 2315 38 0000 0000 19 23	0...100	200	4...20 mA; 2 relays 30 W (max. 1 A)/36 VAC/DC	±0.5
DCS250.0AR	8864 74 2315 38 0000 0000 19 23	0...250	500	4...20 mA; 2 relays 30 W (max. 1 A)/36 VAC/DC	±0.5

Additional information

Documents		
	Data sheet	www.trafag.com/H72605
	Instructions	www.trafag.com/H73605
	Flyer	www.trafag.com/H70676

Specifications		
Accuracy	TEB typ. @ -25 ... +85°C	± 1.0 % FS typ.
	Accuracy @ 25°C typ.	± 0.5 % FS typ.
	NLH @ 25°C (BSL) typ.	± 0.25% FS typ.
	TC zero point and span typ.	± 0.01% FS/K typ.
	Long term stability 1 year typ.	± 0.2 % FS typ.
	Sensor temperature	± 2.5°C
Electrical Data	Output / supply voltage	4 ... 20 mA: 24 (11 ... 32) VDC 0 ... 10 VDC: 24 (15 ... 30) VDC
	Rise time	Typ. 1 ms / 10 ... 90 % nominal pressure
	Current consumption	< 70 mA
Environmental conditions	Media temperature	-25°C ... +125°C
	Ambient temperature	-25°C ... +80°C (LCD display active -10°C ... +70°C)
	Protection ¹⁾	IP65
	Humidity	Max. 95 % relative
	Vibration	10 g (25...2000 Hz)
	Shock	50 g / 1 ms
EMC Protection	Emission	EN/IEC 61000-6-3
	Immunity	EN/IEC 61000-6-2
Mechanical Data	Sensor (wetted parts)	1.4542 (AISI630)
	Pressure connection (wetted parts)	Pressure ranges < 100 bar: 1.4542 (AISI630) Pressure ranges ≥ 100 bar: 1.4404 (AISI316L)
	Housing	1.4301 (AISI304)
	Sealing	NBR 70 Sh
	Male electrical plug	8-pole (PA) U _{max} : 30 VAC / 36 VDC
	Weight	~ 200 g
	Mounting torque	25 Nm

¹⁾ Provided female connector is mounted according to instructions

Display	
LCD Display	Back-lit
4-Digit resolution	≤ 0.2% FS
Display range	-5 ... 125 % FS
Operation	Menu selection with 2 buttons
Setting parameters	See dimensions

Relay output	
Output	2 Relays, electrically isolated 30W (max.1A), 36 VAC / DC
Switching time	5 ... 9999 ms, adjustable
Switching hysteresis	typ. 1 ... 99 % FS

Dimensions

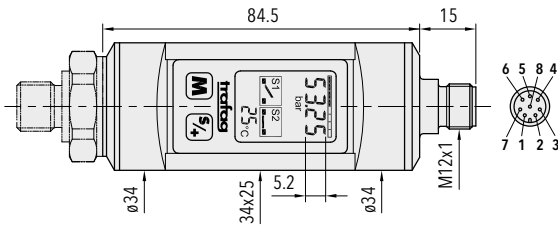

8864.XX.23XX.XX.XX.XX

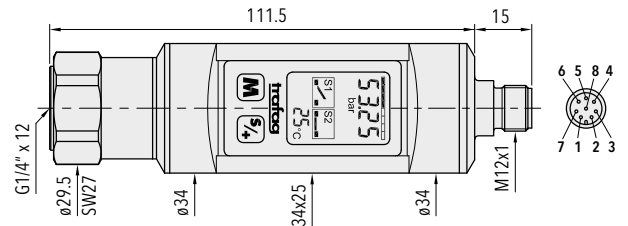

8864.XX.2310.XX.XX.XX

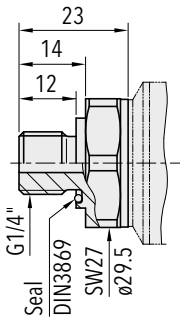

8864.XX.2317.XX.XX.XX

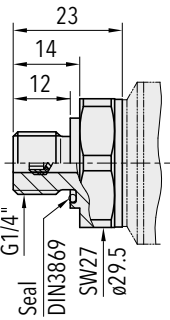

8864.XX.2315.XX.XX.XX

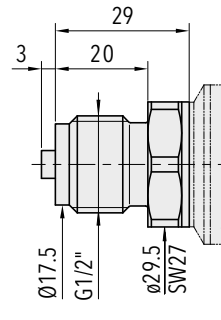

8864.XX.2311.XX.XX.XX

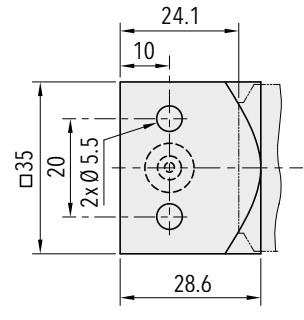

8864.XX.2341.XX.XX.XX

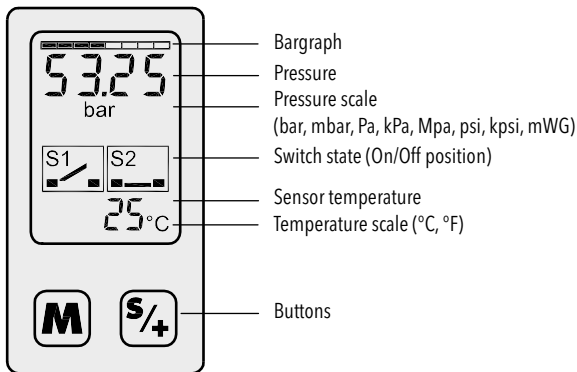

Adjustment parameters

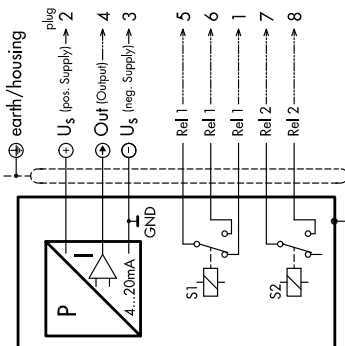

4 ... 20 mA/ 2 relays
8864.XX.XXXX.XX.19.23

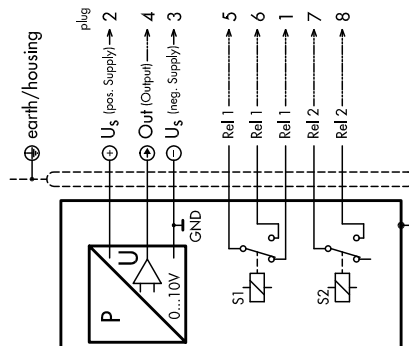

0 ... 10 VDC/ 2 Relays
8864.XX.XXXX.XX.17.23

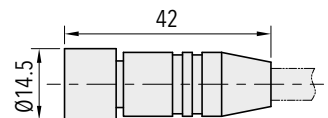

DCS CON

Cable length 2 m
Cable material PUR
Shield on screw

- | | |
|------------|----------|
| 1 = white | 5 = grey |
| 2 = brown | 6 = pink |
| 3 = green | 7 = blue |
| 4 = yellow | 8 = red |



Accessories 

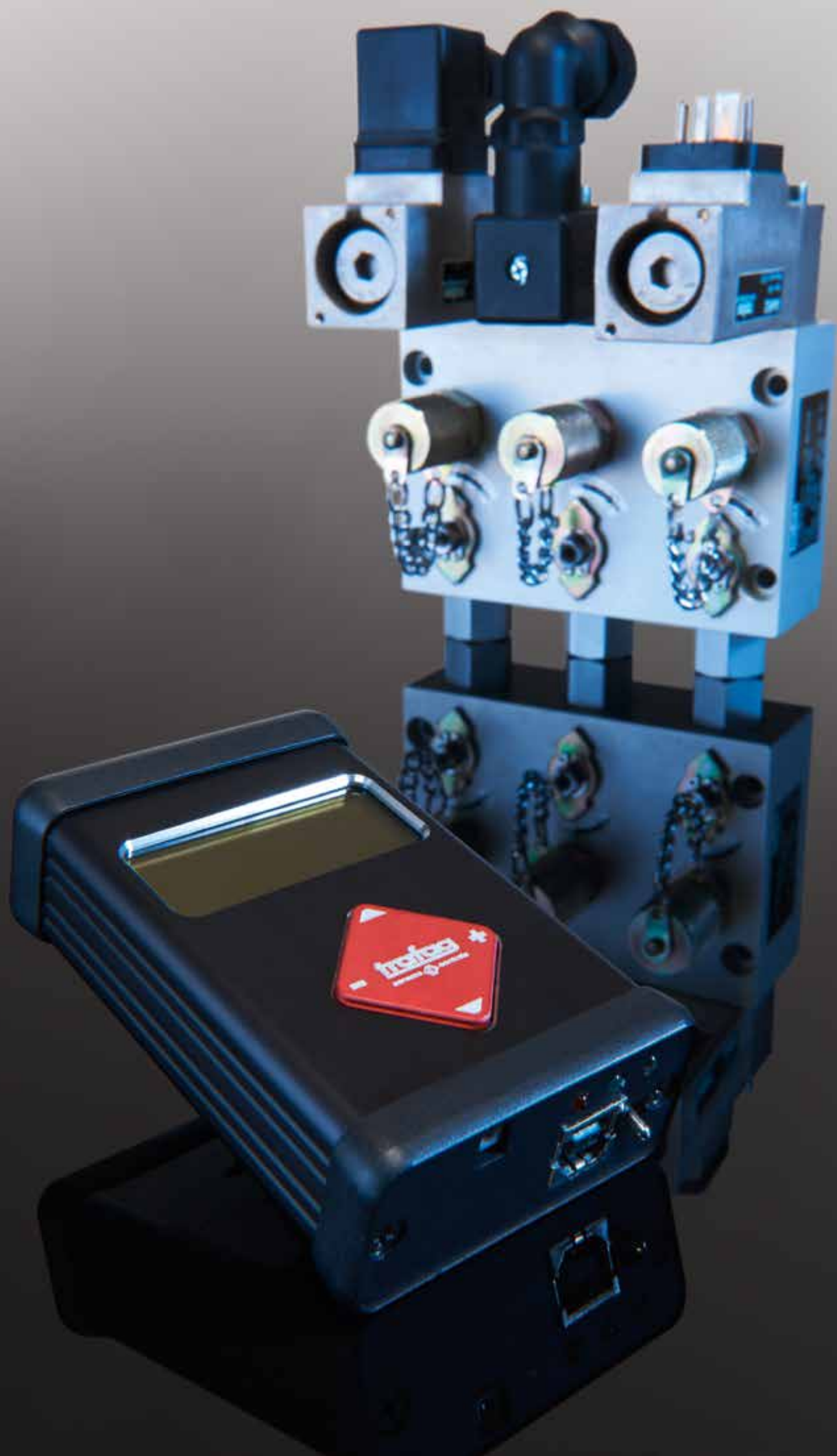

Accessories

Trafag offers a wide range of original accessories which are ideally matched to our products. These include devices for monitoring or configuring transmitters such as hand pumps with precision pressure gauge or the Sensor Communicator, a handheld device which provides direct access to the calibration values of the transmitter in the Trafag ASIC. Trafag also offers a wide range of accessories meet specific application requirements and also make installation easier. They include diagnostic valve manifolds, snubbers and pressure peak damping elements for measuring pressure, or protective pipes for thermostats.

Accessories for pressure measurement instruments

- SMI Sensor Master Interface
- Sensor Communicator
- CAN2USB CANopen Configuration Tool
- DVB Diagnostic Valve Block
- Hand pump with precision manometer
- Switch amplifier
- Venting box
- Cable hanger
- Pressure peak damping element
- Snubber
- Adapters for different pressure connections
- Stop valve

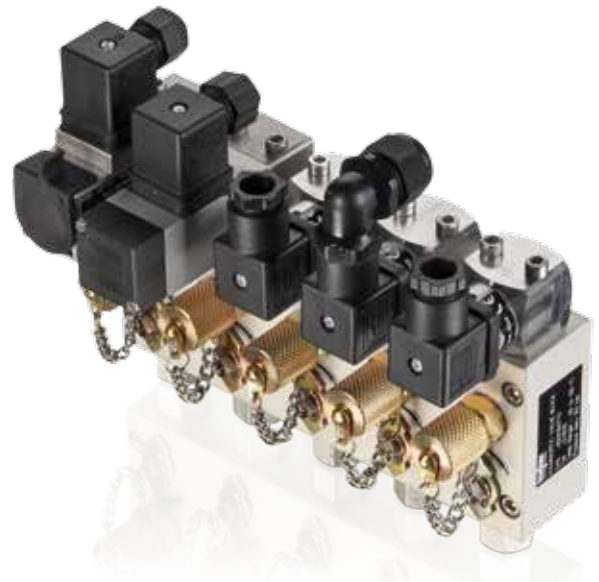

SMI

Sensor Master Interface

(available from the 2nd quarter of 2018)

Swiss based Trafag is a leading international supplier of high quality sensors and monitoring instruments for measurement of pressure and temperature. The Sensor Master Interface SMI is used to set parameters of electronic pressure switches such as switching points, output function and switching delay time as well as to adjust the measuring range of submersible pressure transmitters. By reading the device data, the connected pressure measurement device can be precisely identified and the parameters can be checked.



Applications

- Supports device types NAT 8252, NAH 8254, NAR 8258, ECL 8439

Features

- Read out of sensor data
- Set switching points with pressure switch NAX
- Set measuring range with submersible pressure transmitter ECL
- Operation via Android App «Sensor Master Communicator SMC»
- Reset pressure measuring instruments to factory settings

Technical Data

Ambient temperature	-10°C ... +40°C	Storage temperature	-10°C ... +50°C
Supply voltage	5 VDC, 1 A (Supply via USB interface)	Dimensions LxBxH	120x76x27 mm
Protection	IP20	Communication SMC/SMI	via Bluetooth

SMI

Ordering information

		Ordering-No.
SMI Packet containing:		F90170 (available from the 2nd quarter of 2018)
SMI		
USB Bluetooth Dongle BLED		F90172
Device connector SMI (5-pole, push-in)		F90171
Cable USB 2.0 A male, Micro-B 1.0m black		F90173
Accessories		
Cable PVC, M12x1 connector		F90174
Device connector SMI with housing (5-pole)		F90175
Case for SMI and accessories (325x248x50 mm)		H30782

Dimensions

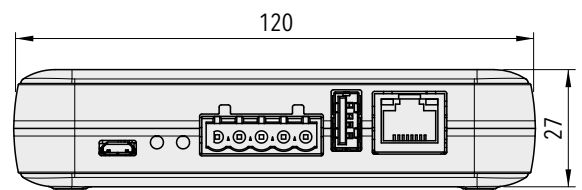
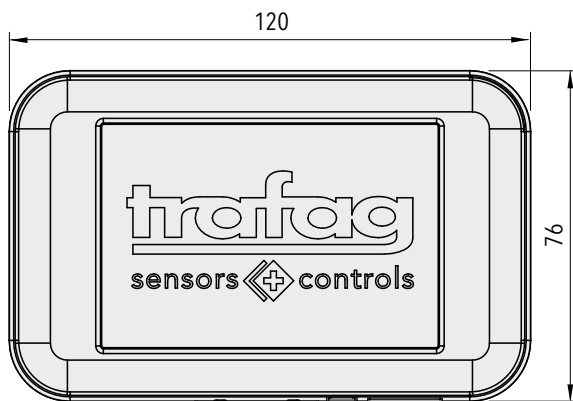

Accessories

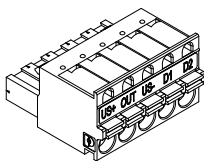

F90171

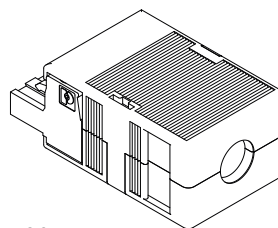

F90175

Additional information

Documents		
	Data sheet	www.trafag.com/H72618
	Instructions	www.trafag.com/H73618
	Flyer	www.trafag.com/H70602

SC

Sensor Communicator



Features

- Read out of sensor data
- Adjustment of set point or zero point and span
- Real time pressure measuring
- Software update and battery charge with USB-interface

Technical Data

- Identification of device data: Model, signal output, type plate, manufacturing date
- Setting of switchpoint (8320 EPN-S)
- CANopen: Setting of Node-ID and baudrate
- Reset to factory settings



Instruction www.trafag.com/H73699 en
H73698 de

Compatible devices and adapter cables

Model	Connector	4 ... 20 mA	Output signal	
			0 ... 10 VDC 0 ... 5 VDC 1 ... 6 VDC	0.5 ... 4.5 VDC ratiometric
NAT (8251) NAH (8253) NAE (8255) NSL (8257)	Industrial standard 82XX.XXXX.01.XX..	SC01A	SC01V	SC01R
	M12, 4-pole 82XX.XXXX.32.XX..	SC32A	SC32V	SC32R
	M12, 5-pole 82XX.XXXX.35.XX..	SC35A	SC35V	SC35R
Model	Connector	4 ... 20 mA	Output signal	
			CANopen SC35CAN	Switching output
CMP (8270)	M12, 5-pole 82XX.XXXX.35.XX..			
EPN-S (8320)	DIN43650 8320.XXXX.40.XX..			SC04SW
EPR (8293) EPN (8298) NPN (8264)	DIN43650 82XX.XXXX.04.XX..	SC04A		
	DIN43650 (invers) 82XX.XXXX.04.XX.92..	SC04A92		

Connection scheme

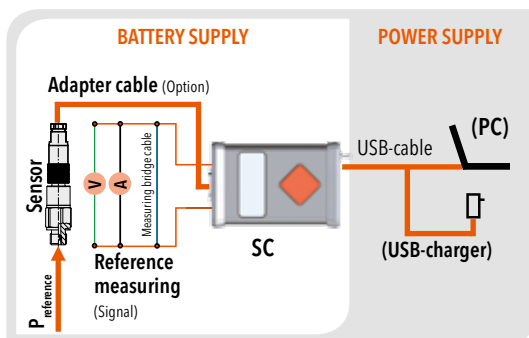

Content of delivery:

- 1 pce SC incl. batteries
- 1 pce USB-cable
- 1 pce Measuring bridge cable
- Option: Adapter cable (see table)

CAN2USB

CANopen Configuration Tool



Features

- Configuration of Trafags pressure transmitter CMP 8270 via USB
- Easy to use visual user interface
- Integrated datalogger
- Complete set available at Trafag AG
- System requirements: Windows 7, Windows 8, Windows 10, USB 2.0 or higher

Technical Data

Configuration of CANopen devices is for non-experts a very difficult task. Common software is geared towards experts with a lot of background knowledge and routine in programming such devices. Neither the software user interface nor hardware like connectors and adapter cards are a comfortable solution for occasional users. The CMP CANopen Configuration tool, developed and produced for Trafag CMP 8270 CANopen pressure transmitter, is the perfect solution for this: Easy-to-use software interface and a USB-to-CANopen dongle. It allows configuration of all CANopen parameters and access to the complete object dictionary. Live display of the actual measurements of pressure and temperature and an integrated logger with export function offers easy monitoring of the CANopen bus communication.



Instruction

www.trafag.com/H73617



Content of delivery:

- CAN2USB adapter
- Cable from adapter to USB
- T-connector M12 F-F-M
- Terminator 120 Ω
- USB Memory stick with software and manual for CAN2USB and CMP 8270

Recommended accessory (not included):

- CMP0.6M: CANopen Pressure Transmitter 8270 CMP with pressure range 0 ... 0.6 bar
- C29161: Pressure applicator



DVB

Diagnostic Valve Block

Features

- Function tests during operation (no interruption necessary) with stop valve and test connection



Technical Data

Pressure	-0.8 ... 100 bar
Ambient temperature	-20°C ... +120°C



Data sheet
Instruction

www.trafag.com/H72361
www.trafag.com/H73361

Standard products (extra short lead time)

Product No		Material	Product No		Material
DVB11	1 P-in, 1 test connection, 1 P-out	Al, PEEK, FPM	DVB24	1 P-in, 4 test connection, 4 P-out	Al, PEEK, FPM
DVB12	2 P-in, 2 test connection, 2 P-out	Al, PEEK, FPM	DVB25	1 P-in, 5 test connection, 5 P-out	Al, PEEK, FPM
DVB13	3 P-in, 3 test connection, 3 P-out	Al, PEEK, FPM	DVB32	1 P-in, 1 test connection, 2 P-out	Al, PEEK, FPM
DVB14	4 P-in, 4 test connection, 4 P-out	Al, PEEK, FPM	DVB33	1 P-in, 1 test connection, 3 P-out	Al, PEEK, FPM
DVB15	5 P-in, 5 test connection, 5 P-out	Al, PEEK, FPM	DVB34	1 P-in, 1 test connection, 4 P-out	Al, PEEK, FPM
DVB22	1 P-in, 2 test connection, 2 P-out	Al, PEEK, FPM	DVB35	1 P-in, 1 test connection, 5 P-out	Al, PEEK, FPM
DVB23	1 P-in, 3 test connection, 3 P-out	Al, PEEK, FPM			

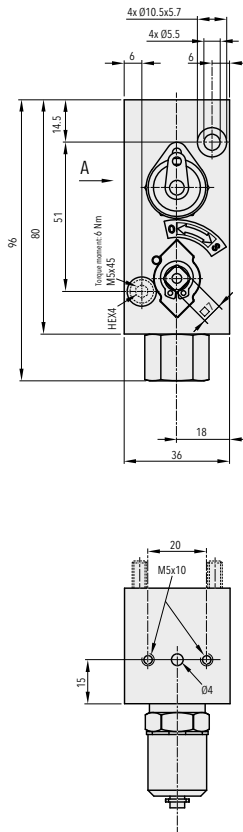
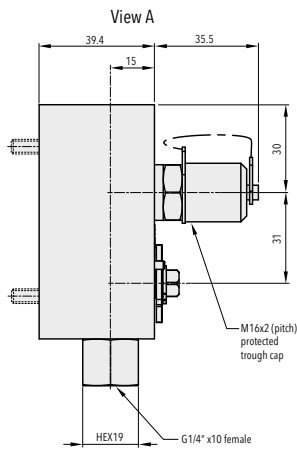
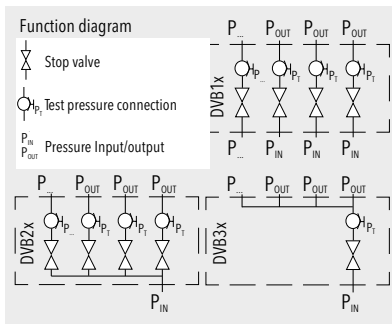

DVB11

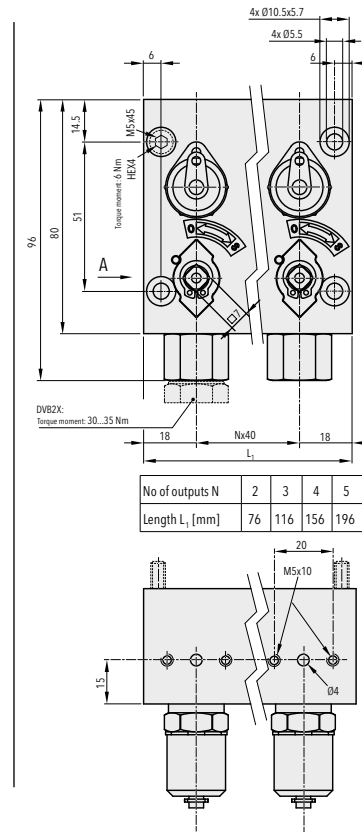

DVB X2... X5

THP...

Hand pump

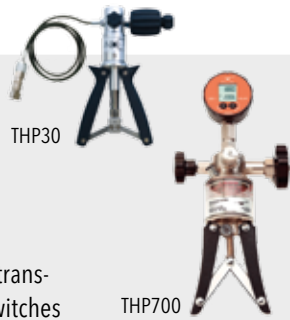

Features

- For testing of pressure transmitters and pressure switches

Technical Data

Connection G1/4" female

Standard products (extra short lead time)

Product No	Range [bar]	
THP30	-0.85 ... +25	
THP700	0 ... 700	Resolution 0.2 bar

ZEN...

Switch amplifier

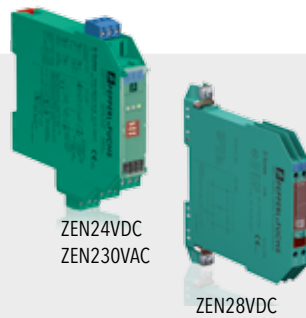

Features

- Ex II 1 G Ex ia IIC Ga
- Ex II 1 D Ex ia IIIC Da
- Ex I M1 Ex ia I Ma
- IP 20
- Output: Signal, relays

Technical Data

Ambient temperature -20°C ... +60°C

The switch amplifier transfers digital signals from the hazardous area. Sensors per DIN EN 60947-5-6 (NAMUR) and mechanical contacts may be used as alarms. The control circuit is monitored for lead breakage (LB).

Standard products (extra short lead time)

Product No	Connection	
ZEN24VDC	20 ... 30 VDC, 20 ... 23 mA	$U_0 = 10.5 \text{ V}$, $I_0 = 13 \text{ mA}$, $P_0 = 34 \text{ mW}$
ZEN230VAC	207 ... 253 VAC, 45 ... 65 Hz	$U_0 = 10.6 \text{ V}$, $I_0 = 19.1 \text{ mA}$, $P_0 = 51 \text{ mW}$
ZEN28VDC	Max. 28 VDC	$U_0 = 28 \text{ V}$, $I_0 = 93 \text{ mA}$, $P_0 = 650 \text{ mW}$

HIP...

Venting box



Features

- For all Trafag level transmitters

Technical Data

Vented plastic housing with wire terminals to connect a submersible pressure transmitter.

Standard products (extra short lead time)

Product No		Material
HIP67	Box 130 x 94 x 57 mm, fixing 4 x Ø 5 mm, hole pattern 115 x 79 mm	Polystyrol, not suitable for outdoor applications

AKL...

Cable hanger



Features

- For all Trafag level transmitters

Technical Data

Cable hanger to clamp cable with diameters of 5.5 ... 9.5 mm

Standard products (extra short lead time)

Product No		Connection	Material
AKL5.5-9.5	174 x 45 x 32 mm	For cable diameters 5.5 ... 9 mm	1.4301, PA fibreglass reinforced

A../D..

Adapters with manometer pressure ports



Features

- Pressure adapters with different thread combinations and materials for individual applications

Technical Data

Material	1.4435 (AISI316L) / Brass
Connection	G1/4"m - G1/2"m, G1/4"m - G3/8"m, G1/4"f - G1/2"m



Data sheet

www.trafag.com/H72258

Standard products (extra short lead time)

Product No		Material
A1	G1/4" male - G3/8" male manometer	Brass
A2	G1/4" male - G1/2" male manometer	Brass
D1	G1/4" male - G3/8" male manometer	1.4435 (AISI316L)
D2	G1/4" male - G1/2" male manometer	1.4435 (AISI316L)
D4	G1/4" female - G1/2" male manometer	1.4435 (AISI316L)

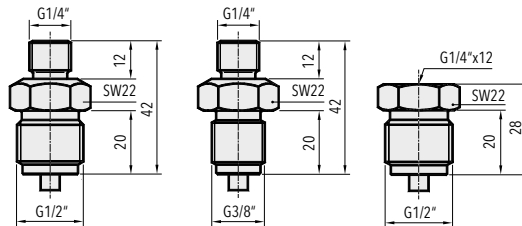

A2/D2

A1/D1

D4

K.../F...

Snubber



Features

- Integrated in an adapter
- K1/K2: Pressure peak damping element integrated in an adapter

Technical Data

Material	1.4435/316L, brass
Connection	G1/4" male - female, G1/8" male - female



Data sheet

www.trafag.com/H72258

Standard products (extra short lead time)

Product No		Connection	Material
F3	Snubber for heavy oil	G1/4" male - female	Brass
F4	Snubber for light oil	G1/4" male - female	Brass
F5	Snubber for water/air	G1/4" male - female	Brass
K1	Snubber for water/air/light oil	G1/4" male - female	1.4435 (AISI316L)
K2	Snubber for water/air/light oil	G1/8" male - female	1.4435 (AISI316L)
K3	Snubber for heavy oil	G1/4" male - female	1.4435 (AISI316L)
K4	Snubber for light oil	G1/4" male - female	1.4435 (AISI316L)
K5	Snubber for water/air	G1/4" male - female	1.4435 (AISI316L)

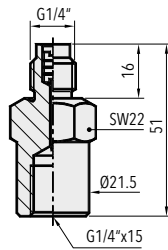

K3/K4/K5
F3/F4/F5

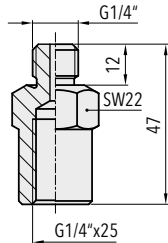

K1

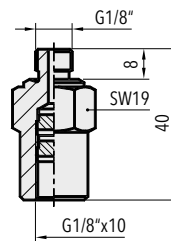

K2

V6/V7

Stop valve



Features

- Allows replacement of instruments without interruption of process (max. 40 bar)

Technical Data

Material	1.4305 / FKM
Pressure	max. 600 bar
Media temperature	-25°C ... +125 °C



Data sheet

www.trafag.com/H72258

Standard products (extra short lead time)

Product No		Connection
V6	For water, air, light-crude, heavy oil	G1/2" male - G1/4" female
V7	For water, air, light-crude, heavy oil	G1/4" male - G1/4" female

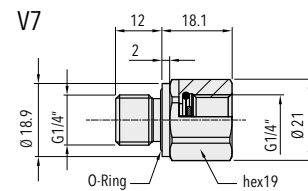
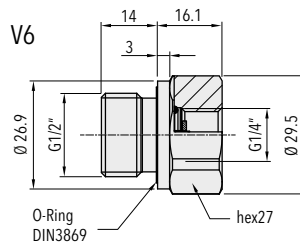

DAMP...

Pressure peak damping element



Features

- Retrofit kit with integrated M5 male thread
- Hole diameter 0.4 mm, 1.0 mm
- Set of 5 pcs.

Technical Data

Material	1.4305 (AISI303)
----------	------------------



Data sheet

www.trafag.com/H72258

Standard products (extra short lead time)

Product No		Material
DAMP1.0	With 1.0 mm hole, for heavy oil	1.4305 (AISI303)
DAMP0.4	With 0.4 mm hole, for water and light oil	1.4305 (AISI303)

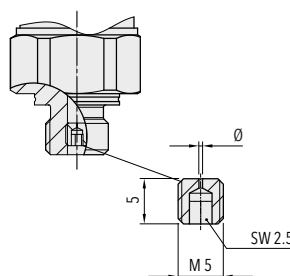

Terminology for pressure measurement instruments

Relevant standards

DIN 16086, IEC 61298-2

Instrument types

Pressure sensors

Membranes with elements applied whose physical properties change when the membranes deform (strain gauges with changing resistance, for example).

Pressure transmitters

Transmitters for converting the pressure to be measured into a defined or standardised analogue and/or digital output signal.

Pressure transducers

Pressure sensors that have a process connection and electrical connection (e.g. connector) but do not convert pressure into a standardised electrical signal like a pressure transmitter.

Types of pressure measurement

Differential pressure measurement

The measurement of differential pressure of two different pressures. The measuring instrument has two pressure connections.

Absolute pressure measurement

The measuring result is always the deviation to the absolute zero (vacuum).

e.g. 4 mA = 0 bar (= vacuum); zero point (ZP): 0 bar

Relative pressure measurement DIN 16086: overpressure

The measuring result is always the deviation to the current, absolute atmospheric pressure.

e.g. 4 mA = 960 mbar (= atmospheric pressure); zero point (ZP): 0 bar

Relative pressure measurement

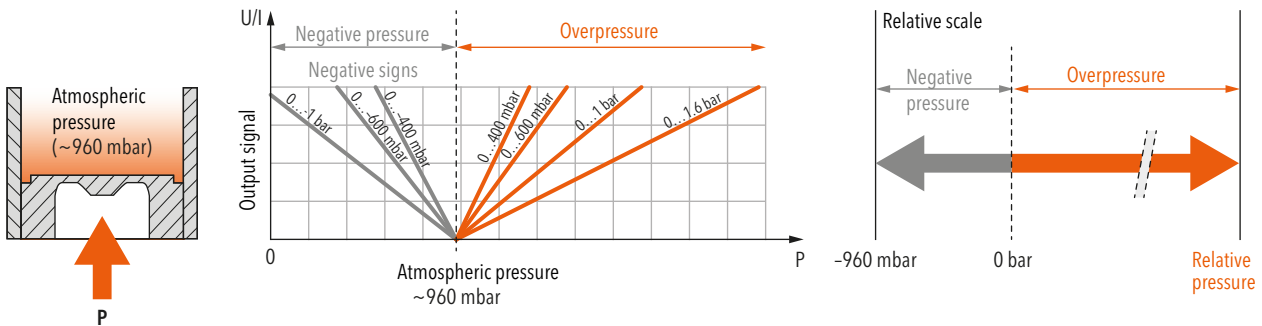

Absolute pressure measurement

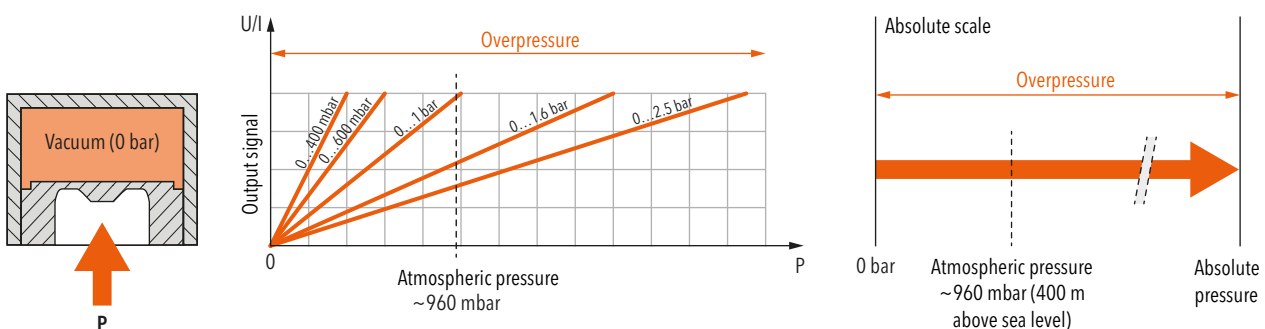

Terminology for pressure measurement instruments

Main features

Nominal pressure measuring range

Range between the upper and lower limits of the size measured (operating pressure). The specified accuracy remains within this range.

Measuring span

Algebraic difference between the upper and lower limit values of a certain measuring range.

Overpressure Max. working pressure

Highest pressure specified by manufacturer for which the pressure transformer is designed at maximum temperature. The pressure transformer can be loaded up to this pressure without the guaranteed metrological properties having changed after going back into the measuring range. However, there is no longer a clear link between pressure and output signal in the range between nominal pressure and overpressure.

Burst pressure

Pressure value (static) at which the measuring instrument suffers permanent damage. The instrument can withstand pressures up to this value without bursting and will not leak any measuring medium.

Example

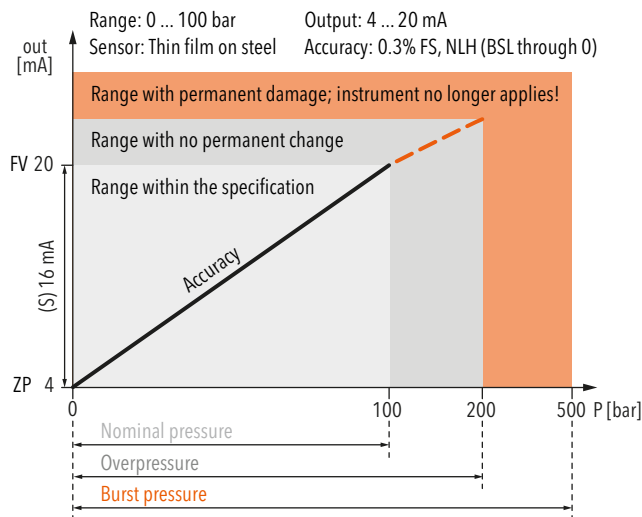

Accuracy

Typ. accuracy

(Typical) Mostly corresponds to the 1-sigma value of the normal distribution, i.e. approx. 68.3%. Generally, well over 75% of all Trafag instruments meet this typical measured value.

Max. accuracy

(maximum) 100% of all instruments meet this maximum measured value.

Non-linearity

The largest deviation from the effective characteristic line of an ideal reference line. The reference line can be defined as a limit point adjustment, a BSL or a BSL through 0.

Specifications: Non-linearity, Hysteresis

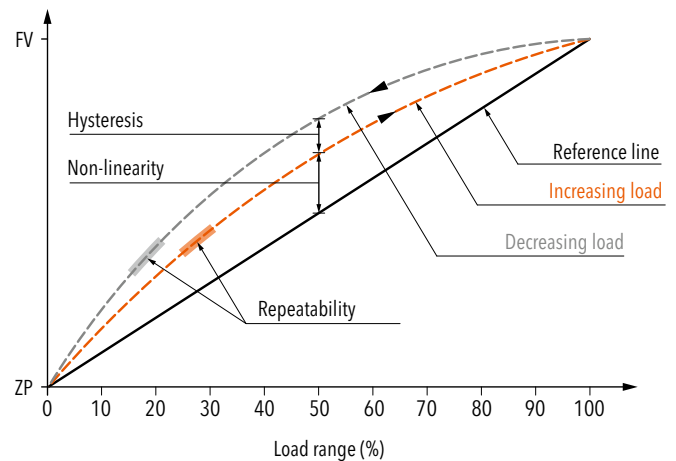

BSL Best Straight Line

The reference line according to the BSL or the minimum value adjustment is placed in such a way that the maximum positive and negative deviations are as small as possible.

Specifications: Accuracy NLH (BSL)

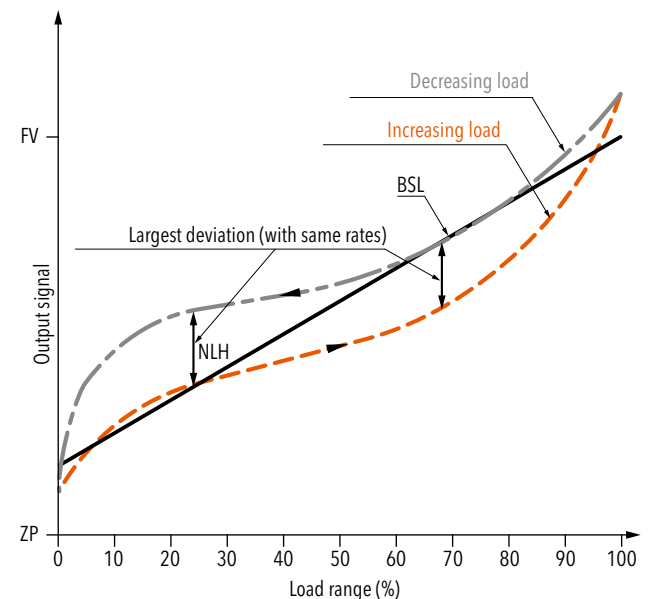

Terminology for pressure measurement instruments

BSL through zero

As an additional requirement for the minimum value adjustment, the BSL through zero (also BSL/0) must go straight through zero or the origin.

Specifications: Accuracy NLH (BSL through zero)

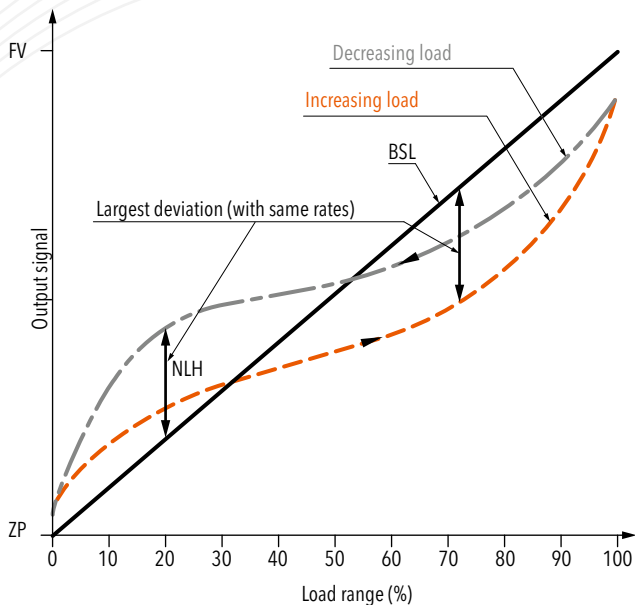

Non-linearity according to limit point adjustment

The reference line runs through the origin and end point of the characteristic line. Non-linearity indicates the greatest deviations from this line.

Hysteresis

Property of an instrument for yielding different output values in relation to its input values, which are dependent on the effective direction in which the input values are created (acc. to IEC 61298-2).

Pressure hysteresis

The difference that occurs at the same pressure between measurements in the direction of increasing and then decreasing pressure.

Temperature hysteresis

Maximum change of the zero point and output span for the pressure signal after specified temperature cycle over the operating temperature range.

NLH non-linearity and hysteresis

Largest deviation from the ideal characteristic line (BSL, BSL/0 or limit point). In pressure measuring instruments, the non-linearity and pressure hysteresis are given together at a constant temperature.

Accuracy DIN 16086: Measurement deviation

The accuracy denoted in the standard DIN 16086 with measurement deviation (at 25°C reference temperature) includes all deviations as a result of non-linearity, hysteresis, non-repeatability, zero point (start of measuring range) errors and span (end of measuring range) errors. Zero point errors and span errors also include the measuring uncertainty of the configuration ensemble.

Repeatability DIN 16086: Non-repeatability

Deviation of the output signals with same input signals under identical (established) application conditions.

Temperature coefficient TC

Change of measured value for zero point and span as a result of changes in temperature.

Long-term stability Long-term drift

The change of accuracy due to aging under certain reference conditions during a certain period of time, typically 1 year.

TEB Total error band

Total error (root from sum of the square of the deviations) due to measurement deviations (accuracy) and temperature influence (temperature coefficient TC). The temperature influence is usually given in the information from Trafag across a range larger than that given in the standard (-10 ... +60 °C). Whilst DIN 16086 also continues to add to the long-term stability over a year, the information from Trafag is subject to ex-works conditions for obvious reasons.

Scale accuracy

For pressostats: Deviation arising from the manual switch point adjustment with the help of the display (scale).

Electrical Data

Output signal

Electrical signal that emits the value of the measurement size for further processing

Rise time Step response

The time it takes for an output signal after a severe pressure change to increase from 10% to 90% of its final value that results from the change in pressure.

Zero point ZP

Output signal in the pressureless state (P_{\min}), e.g. 4 mA at 0 bar (P_{\min}).

Terminology for pressure measurement instruments

Final value FV

Output value of the largest pressure value in the nominal pressure range (P_{max}), e.g. 20 mA at 100 bar (P_{max}).

Span S

Final value (FV) - zero point (ZP) = span (S)
e.g. span (S) = (FV) 20 mA - (ZP) 4 mA = 16 mA

Switching differential Pressostats

Range within which the micro-switch in pressostats switches on and off

Example:

X...X = adjustable value

X - X = non-adjustable value; runs proportional to the nominal pressure

X = fixed value

Limiter Pressostats

Pressostat with manual micro-switch reset.

Environmental conditions

Media temperature

Permissible temperature range of the measuring media.

Operating temperature Ambient temperature

Temperature range in which the measuring instrument adheres to its specifications. As the electronics in certain instruments are more sensitive to temperature than the sensor element, the maximum ambient temperature for the instrument is lower than the permissible media temperature.

Storage temperature

Temperature range in which the measuring instrument can be stored or transported without permanently changing the measuring characteristics.

Protection

Humidity and dust shield according to IP classes in accordance with EN 60529.

EMC Protection

EMC Electromagnetic compatibility

Instrument property for functioning in an environment with electromagnetic interference and for not unduly influencing this environment (to which other equipment also belongs).

Immision

Immunity to external electromagnetic disturbances.

Emission

Interference emission from electromagnetic disturbances.

Surge

Immunity to unipolar surge voltages that can occur due to surges as a result of switching operation and lighting.

Burst

Immunity to recurring, rapid, transient electrical disturbances.

Information on Ex products

Trafag offers a wide range of EX-, ATEX- and IECEx approved products for pressure and temperature monitoring. These products provide reliable functionality in various hazardous zones, with a guaranteed safety operation. In addition to both CE and ATEX-conformance, Trafag products are also extremely fail-safe.

CE - Designation and labelling

CE 1258 **Ex** **II 2** **GD**

Control No. of notified body for the supervision of the quality assurance system

I: Mining
II: All other applications

Category (see below)

G = Gas
D = Dust

- Category 1: Can be used in zone 0 (gas) and 20 (dust)
 - Potentially explosive atmosphere: Permanent
 - Two independent failures – safety
- Category 2: Can be used in zone 1 (gas) and 21 (dust)
 - Potentially explosive atmosphere: Regularly
 - One failure – safety
- Category 3: Can be used in zone 2 (gas) and 22 (dust)
 - Potentially explosive atmosphere: Unlikely or for very short time

IEC/EN 60079-8 – Gases

Ex ia IIC T6 Ga

Type of protection

Equipment groups (for gases)

Temperature class

Equipment protection level

- Type of protection: Intrinsically safe
- Equipment group (gases): IIC = Hydrogen, Acetylene
- Temperature level: Defines ignition temperature and permissible temperature of equipment surface
- Protection level: Referring to installation zone (Ga = Zone 0 = Category 1 in ATEX)

IEC/EN 60079-0 – Dust

Ex ia IIIC IP6X T130 °C Da

Type of protection

Equipment groups (for dust)

IP protection

Surface temperature

Equipment protection level

- Type of protection: Intrinsically safe, powder filling, encapsulation, ...
- Equipment group (dust): IIIC = Conductive dust
- Temperature level: Defines maximum surface temperature
- Protection level: Referring to installation zone (Da = Zone 20 = Category 1 in ATEX)

EN 50303 – Mining

Ex ia I Ma

Type of protection

Equipment for mining

Equipment protection level

- Category and Protection level:
 - Category M1 / Protection level Ma: Fully functional and safe when explosive atmosphere is present. Requires means to cope with two independent failures
 - Category M2 / Protection level Mb: These products are intended to be deenergised in the presence of an explosive atmosphere

Fluid resistance guide

CODES: S - SATISFACTORY F - FAIR U - UNSATISFACTORY T - TEST FOR SPECIFIC APPLICATION		RESILIENT MATERIALS	PLASTICS	METALS	
BRUNNEN (BRUNNEN)	ETIKETT (ETIKETT)	BRUNNEN (BRUNNEN)	BRUNNEN (BRUNNEN)	BRUNNEN (BRUNNEN)	
BRUNNEN (BRUNNEN)	BRUNNEN (BRUNNEN)	BRUNNEN (BRUNNEN)	BRUNNEN (BRUNNEN)	BRUNNEN (BRUNNEN)	
U	S	S	S	S	Acetaldehyde
S	S	S	S	S	Acetamide
U	S	S	S	S	Acetate, Amyl
U	S	S	S	S	Acetic acid, 10%
T	S	S	S	S	Acetic acid, Glacial
U	S	S	S	S	Acetic anhydride
U	S	S	S	S	Acetone
S	S	S	S	S	Acetylene gas
U	S	S	S	S	F. Acetylene tetra-chloride
U	S	S	S	S	S. Acrylic acid
U	S	S	S	S	Alcohol amyl
F	S	S	S	S	Alcohol ethyl (Ethanol)
U	S	S	S	S	Alcohol methyl (Methanol)
U	S	S	S	S	Alkazine
S	S	S	S	S	Alumina
S	S	S	S	S	Aluminum chloride
S	S	S	S	S	Aluminum oxide
S	S	S	S	S	Aluminum hydroxide
S	S	S	S	S	Aluminum potassium sulfate
F	S	S	S	S	Aluminum potassium 10%
F	S	S	S	S	Aluminum sodium sulfate
F	S	S	S	S	Aluminum sulfate (Alum)
F	S	S	S	S	Ammonia
S	S	S	S	S	Ammonium bicarbonate
S	S	S	S	S	Ammonium bromide
S	S	S	S	S	Ammonium carbonate
S	S	S	S	S	Ammonium chloride
S	S	S	S	S	Ammonium hydroxide
S	S	S	S	S	Ammonium monophosphate
S	S	S	S	S	Ammonium nitrate
S	S	S	S	S	Ammonium nitrate hydroxide 20%
F	S	S	S	S	Ammonium persulfates 5%
S	S	S	S	S	Ammonium phosphate
S	S	S	S	S	Ammonium sulfate
S	S	S	S	S	Ammonium sulfite
S	S	S	S	S	Ammonium triphosphate
U	S	S	S	S	Amyl acetate
U	S	S	S	S	Aniline dyes
U	S	S	S	S	Aniline hydrochloride
F	S	S	S	S	Antimony trichloride
S	S	S	S	S	Antioxidants
F	S	S	S	S	Argon gas
T	S	S	S	S	Aromatic hydrocarbons
S	S	S	S	S	Arsenic acid
S	S	S	S	S	Arsenic trichloride
F	S	S	S	S	Asphalt
S	S	S	S	S	Barium chloride 5%
S	S	S	S	S	Barium hydroxide
F	S	S	S	S	Barium nitrate
U	S	S	S	S	Barium sulphide
U	S	S	S	S	Beer
U	S	S	S	S	Beet sugar liquid
U	S	S	S	S	Benzene benzol (Benzene)
U	S	S	S	S	Benzaldehyde
U	S	S	S	S	Benzoic acid
S	S	S	S	S	Black sulfate liquor
T	S	S	S	S	Blast furnace gas
S	S	S	S	S	Bleaching powder, wet
U	S	S	S	S	Blood
S	S	S	S	S	Borax
S	S	S	S	S	Boric acid
S	S	S	S	S	Brake fluid (non-petroleum)
U	S	S	S	S	Brine
U	S	S	S	S	Bromine dry
U	S	S	S	S	Bromine, wet
S	S	S	S	S	Butadiene (gas)
S	S	S	S	S	Butane
S	S	S	S	S	Butanol
S	S	S	S	S	Buttermilk
U	S	S	S	S	Butyl acetate
S	S	S	S	S	Butyl alcohol
T	S	S	S	S	Butyl stearate
U	S	S	S	S	Butyric acid
F	S	S	S	S	Calcium acetate
S	S	S	S	S	Calcium bisulfite
U	S	S	S	S	Calcium carbide
S	S	S	S	S	Calcium carbonate
F	S	S	S	S	Calcium chlorate
F	S	S	S	S	Calcium chloride
S	S	S	S	S	Calcium uric acid
S	S	S	S	S	Calcium hydroxide
U	S	S	S	S	Calcium hypochlorite
S	S	S	S	S	Calcium nitrate
S	S	S	S	S	Calcium sulfate
S	S	S	S	S	Calcium sulphide
S	S	S	S	S	Calgen
S	S	S	S	S	Caliche liquid
S	S	S	S	S	Cane sugar syrup
U	S	S	S	S	Carbolic acid (Phenol)
U	S	S	S	S	Carbon bisulfide
S	S	S	S	S	Carbon dioxide dry
U	S	S	S	S	Carbon disulfide
F	S	S	S	S	Carbon monoxide
U	S	S	S	S	Carbon tetrachloride
S	S	S	S	S	Carbonated water

CODES: S - SATISFACTORY F - FAIR U - UNSATISFACTORY T - TEST FOR SPECIFIC APPLICATION		RESILIENT MATERIALS	PLASTICS	METALS	
BRUNNEN (BRUNNEN)	ETIKETT (ETIKETT)	BRUNNEN (BRUNNEN)	BRUNNEN (BRUNNEN)	BRUNNEN (BRUNNEN)	
BRUNNEN (BRUNNEN)	BRUNNEN (BRUNNEN)	BRUNNEN (BRUNNEN)	BRUNNEN (BRUNNEN)	BRUNNEN (BRUNNEN)	
T	S	S	S	S	Carbonic acid
S	S	S	S	S	Castor oil
U	S	S	S	S	Cellulosic (see Ethyl acetate)
U	S	S	S	S	Cellulose
T	S	S	S	S	China wood oil (Tung)
U	S	S	S	S	Chlordane
U	S	S	S	S	Chlorides, organic
S	S	S	S	S	Chloric acid
U	S	S	S	S	Chlorinated water
U	S	S	S	S	Chlorinated solvents
U	S	S	S	S	Chlorine anhydrous liquid
U	S	S	S	S	Chlorine, gas
U	S	S	S	S	Chlorine, dioxide
U	S	S	S	S	Chlorine trifluoride
U	S	S	S	S	Chloroacetic acid
U	S	S	S	S	Chlorobenzene
U	S	S	S	S	Chloroform
U	S	S	S	S	Chlorosulfonic acid, diluted
S	S	S	S	S	Chlorosulfonic acid, diluted
U	S	S	S	S	Chlorox
F	S	S	S	S	Choline chloride
U	S	S	S	S	Chromic acid
U	S	S	S	S	Chromic acid solution
U	S	S	S	S	Chromic acid
S	S	S	S	S	Chromium-potassium sulfate
U	S	S	S	S	Chromium sulfate (basic)
S	S	S	S	S	Cider
T	S	S	S	S	Coal tar
S	S	S	S	S	Cocconut oil
T	S	S	S	S	Cod liver oil
S	S	S	S	S	Coffee
T	S	S	S	S	Coke oven gas
T	S	S	S	S	Cooking oil
T	S	S	S	S	Copper acetate
S	S	S	S	S	Copper ammonium acetate
S	S	S	S	S	Copper chloride
S	S	S	S	S	Copper cyanide (elect. pl. sol.)
S	S	S	S	S	Copper nitrate
S	S	S	S	S	Copper sulfate
S	S	S	S	S	Copper sulfate (elect. pl. sol.)
S	S	S	S	S	Corn oil
S	S	S	S	S	Corn starch slurry
S	S	S	S	S	Cottonseed oil
U	S	S	S	S	Croscote
U	S	S	S	S	Cresylic acids (alkyl phenols)
F	S	S	S	S	Cupric chlorides 5%
U	S	S	S	S	Dibutyl phthalate
S	S	S	S	S	Diesel fuel
S	S	S	S	S	Diesel oil, light
U	S	S	S	S	Diethyl ether
U	S	S	S	S	Dichloroethane
U	S	S	S	S	Dichloroethane (low chem. #200)
F	S	S	S	S	Disinfectant
U	S	S	S	S	D.L.E., Lubricating oil
U	S	S	S	S	Dowtherm A or E
T	S	S	S	S	Enamel
U	S	S	S	S	Esso #90 line
S	S	S	S	S	Ethane
U	S	S	S	S	Ether
U	S	S	S	S	Ethyl acetate
U	S	S	S	S	Ethyl benzene
S	S	S	S	S	Ethyl cellulose
S	S	S	S	S	Ethyl chloride
U	S	S	S	S	Ethyl metacaptan
U	S	S	S	S	Ethyl sulfate
U	S	S	S	S	Ethylene
S	S	S	S	S	Ethylene bromide
T	S	S	S	S	Ethylene chloride
U	S	S	S	S	Ethylene dibromide
U	S	S	S	S	Ethylene dichloride
S	S	S	S	S	Ethylene glycol
U	S	S	S	S	Ethylene oxide
F	S	S	S	S	Emulsifying fluid
F	S	S	S	S	Ethanol (see alcohol-ethyl)
T	S	S	S	S	Fatty acids
S	S	S	S	S	Ferric chloride
T	S	S	S	S	Ferric nitrate
S	S	S	S	S	Ferric sulfate
T	S	S	S	S	Ferrous ammonium sulfate
S	S	S	S	S	Ferrous chloride
S	S	S	S	S	Ferrous sulfate
S	S	S	S	S	Fish oil
S	S	S	S	S	Fluoboric acid
U	S	S	S	S	Fluorene
S	S	S	S	S	Fluoric acid
S	S	S	S	S	Formaldehyde
U	S	S	S	S	Formic acid
F	S	S	S	S	Freon 11
S	S	S	S	S	Freon 12
S	S	S	S	S	Freon 13
U	S	S	S	S	Freon 21

Due to the numerous different application possibilities Trafag cannot accept any guarantee for the correctness of these recommendations. We therefore suggest that for a particular application you carry out tests to verify the fluid resistance.

Conversion of pressure units

	bar	mbar	Pa N/m ²	kPa kN/m ²	MPa MN/m ²	at kp/cm ²	atm	mmWS mmCE	mWS mCE	Torr mm Hg	psi lbf/in ²
1 bar	1	1000	10 ⁵	100	0.1	1.02	0.987	1.02·10 ⁴	10.2	750	14.5
1 mbar	0.001	1	100	0.1	10 ⁻⁴	1.02·10 ⁻³	0.987·10 ⁻³	10.2	0.0102	0.75	0.0145
1 Pa 1 N/m²	10 ⁻⁵	0.01	1	0.001	10 ⁻⁶	1.02·10 ⁻⁵	0.987·10 ⁻⁵	0.102	1.02·10 ⁻⁴	0.0075	1.45·10 ⁻⁴
1 kPa 1 kN/m²	0.01	10	1000	1	0.001	0.0102	9.87·10 ⁻³	102	0.102	7.5	0.145
1 MPa 1 MN/m²	10	10 ⁴	10 ⁶	1000	1	10.2	9.87	1.02·10 ⁵	102	7500	145
1 at 1 kp/cm²	0.981	981	0.981·10 ⁵	98.1	0.0981	1	0.968	10 ⁴	10	736	14.22
1 atm	1.013	1013	1.013·10 ⁵	101.3	0.1013	1.033	1	1.033·10 ⁴	10.332	760	14.696
1 mmWS 1mmCE	0.981·10 ⁻⁴	0.098	9.807	9.81·10 ⁻³	9.81·10 ⁻⁶	10 ⁻⁴	0.968·10 ⁻⁴	1	0.001	0.0736	1.422·10 ⁻³
1 mWS 1mCE	0.0981	98.07	9807	9.81	9.81·10 ⁻³	0.1	0.0968	1000	1	73.6	1.422
1 Torr 1 mmHg	1.133·10 ⁻³	1.333	133.323	0.133	1.333·10 ⁻⁴	1.36·10 ⁻³	1.316·10 ⁻³	13.595	1.359·10 ⁻²	1	1.934·10 ⁻²
1 psi 1 lbf/in²	6.895·10 ⁻²	68.95	6895	6.895	6.895·10 ⁻³	7.031·10 ⁻²	0.06805	703.1	0.7031	51.7	1

Conversion of temperature units

[°F] to [°C] Formula: °C = 5/9·(°F - 32)					
°F	°C	°F	°C	°F	°C
-100	-73.3	105	40.6	315	157.2
-95	-70.6	110	43.3	320	160.0
-90	-67.8	115	46.1	325	162.8
-85	-65.0	120	48.9	330	165.6
-80	-62.2	125	51.7	335	168.3
-75	-59.4	130	54.4	340	171.1
-70	-56.7	135	57.2	345	173.9
-65	-53.9	140	60.0	350	176.7
-60	-51.1	145	62.8	355	179.4
-55	-48.3	150	65.6	360	182.2
-50	-45.6	155	68.3	365	185.0
-45	-42.8	160	71.1	370	187.8
-40	-40.0	165	73.9	375	190.6
-35	-37.2	170	76.7	380	193.3
-30	-34.4	175	79.4	385	196.1
-25	-31.7	180	82.2	390	198.9
-20	-28.9	185	85.0	395	201.7
-15	-26.1	190	87.8	400	204.4
-10	-23.3	195	90.6	405	207.2
-5	-20.6	200	93.3	410	210.0
0	-17.8	205	96.1	415	212.8
5	-15.0	210	98.9	420	215.6
10	-12.2	215	101.7	425	218.3
15	-9.4	220	104.4	430	221.1
20	-6.7	225	107.2	435	223.9
25	-3.9	230	110.0	440	226.7
30	-1.1	235	112.8	445	229.4
32	0	240	115.6	450	232.2
35	1.7	245	118.3	455	235.0
40	4.4	250	121.1	460	237.8
45	7.2	255	123.9	465	240.6
50	10.0	260	126.7	470	243.3
55	12.8	265	129.4	475	246.1
60	15.6	270	132.2	480	248.9
65	18.3	275	135.0	485	251.7
70	21.1	280	137.8	490	254.4
75	23.9	285	140.6	495	257.2
80	26.7	290	143.3	500	260.0
85	29.4	295	146.1	505	262.8
90	32.2	300	148.9	510	265.6
95	35.0	305	151.7	515	268.3
100	37.8	310	154.4	520	271.1

[°C] to [°F] Formula: °F = 9/5·(°C + 32)					
°C	°F	°C	°F	°C	°F
-100	-148	105	221	315	599
-95	-139	110	230	320	608
-90	-130	115	239	325	617
-85	-121	120	248	330	626
-80	-112	125	257	335	635
-75	-103	130	266	340	644
-70	-94	135	275	345	653
-65	-85	140	284	350	662
-60	-76	145	293	355	671
-55	-67	150	302	360	680
-50	-58	155	311	365	689
-45	-49	160	320	370	698
-40	-40	165	329	375	707
-35	-31	170	338	380	716
-30	-22	175	347	385	725
-25	-13	180	356	390	734
-20	-4	185	365	395	743
-15	5	190	374	400	752
-10	14	195	383	405	761
-5	23	200	392	410	770
0	32	205	401	415	779
5	41	210	410	420	788
10	50	215	419	425	797
15	59	220	428	430	806
20	68	225	437	435	815
25	77	230	446	440	824
30	86	235	455	445	833
32	89.6	240	464	450	842
35	95	245	473	455	851
40	104	250	482	460	860
45	113	255	491	465	869
50	122	260	500	470	878
55	131	265	509	475	887
60	140	270	518	480	896
65	149	275	527	485	905
70	158	280	536	490	914
75	167	285	545	495	923
80	176	290	554	500	932
85	185	295	563	505	941
90	194	300	572	510	950
95	203	305	581	515	959
100	212	310	590	520	968

Trafag international

Europe

■ Headquarters, Switzerland

Trafag AG
Industriestrasse 11
CH - 8608 Bubikon
Tel. +41 44 922 32 32
www.trafag.com
e-mail: trafag@trafag.com

■ Albania, Bosnia-Herzegovina, Macedonia, Montenegro, Serbia, Slovenia

Axo-Texcomp Services SA
P.O. Box 88
CH - 1164 Buchillon
Tel. +41 21 807 22 01
mbucher@axotex.ch

■ Austria

Trafag GmbH
Konrad-Doppelmayr-Strasse 17
AT - 6922 Wolfurt
Tel. +43 5574 20866
www.trafag.at
e-mail: trafagat@trafag.com

■ Belgium

Marktechnical B.V.B.A.
Boxtelstraat 11
BE - 2320 Hoogstraten
Tel. +32 3 311 8864
www.marktechnical.be
e-mail: info@marktechnical.be

■ Croatia

Albania, Bosnia-Herzegovina, Macedonia, Montenegro, Serbia, Slovenia
VARGA ELEKTRONIK d.o.o.
Draškovićevo 12
Draškovec
HR - 40323 Prelog
Tel. +385 40 643 189
www.varga-elektronik.hr
e-mail: info@varga-elektronik.hr

■ Cyprus

ACTech Ltd.
60 Mesologiu Str, 185-45
GR - Piraeus
Tel. +30 210 4630 825
www.actech.gr
e-mail: actech1@otenet.gr

■ Czech Republic

Trafag spol. s r.o.
Vilémovská 2129
CZ - 347 01 Tachov
Tel. +420 374 723 250
www.trafag.cz
e-mail: prodej@trafag.com

■ Denmark

OEM Automatic Klitsø A/S
Engholm Parkvej 4
DK - 3450 Allerød
Tel. +45 70 10 64 00
www.oemklitso.dk
e-mail: info@oemklitso.dk

■ Estonia, Latvia

Wermundsen OÜ
Pärnu mnt. 142
EE - 11317 Tallinn
Tel. +372 601 4202
www.wermundsen.ee
e-mail: wermundsen@wermundsen.ee

■ Finland

Wexon OY
Turvekuja 6
FI - 00700 Helsinki
Tel. +358 9 290 440
www.wexon.com
e-mail: wexon@wexon.fi

■ France

Trafag S.A.R.L.
2 Boulevard Westinghouse
FR - 93270 Sevran
Tel. +33 1 4863 0101
www.trafag.fr
e-mail: trafagfr@trafag.com

■ Germany

Trafag GmbH
Kelterstrasse 59
DE - 72669 Unterensingen
Tel. +49 7022 40590-0
www.trafag.de
e-mail: info@trafag.de

■ Great Britain

Trafag (UK) Ltd.
Units 12&14, Josselin Court,
Josselin Road
Burnt Mills Industrial Estate
GB - Basildon, Essex SS13 1QF
Tel. +44 1 268 727 172
www.trafag.co.uk
e-mail: enquiries@trafag.co.uk

■ Greece

ACTech Ltd.
60 Mesologiu Str, 185-45
GR - Piraeus
Tel. +30 210 4630 825
www.actech.gr
e-mail: actech1@otenet.gr

■ Hungary

OEM Automatic Kft.
Gyár u.2.
HU - 2040 Budaörs
Tel. +36 23 880 895
www.oemautomatic.hu
e-mail: info@oemautomatic.hu

■ Iceland

Samey ehf.
Lyngas 13
IS - 210 Gardabaer
Tel. +354 510 5200
www.samey.is
e-mail: sala@samey.is

■ Italy

Trafag Italia S.r.l.
c/o Tecnocity Altomilanese
Via Cremona, 1
IT - 20025 Legnano (MI)
Tel. +39 0 331 592 397
www.trafagitalia.com
e-mail: info@trafagitalia.com

■ Netherlands

Marktechnical B.V.
Lage Ham 172-178
P.O. Box 324 / 5100 AH Dongen
NL - 5102 AE Dongen
Tel. +31 162 31 42 85
www.marktechnical.nl
e-mail: info@marktechnical.nl

Trafag international

Europe

■ Norway

Stork AS
Brynsveien 100
NO - 1352 Kolsås
Tel. +47 67 17 64 00
www.stork.no
e-mail: stork@stork.no

■ Poland

POLTRAF Sp. z o. o.
ul. Bysewska 26C
PL - 80-298 Gdańsk
Tel. +48 58 557 52 07
Tel. +48 58 557 52 23
www.poltraf.com
e-mail: info@poltraf.com.pl

■ Portugal

Contimetra Instrumentos Industriais Lda.
Rua do Proletariado, 15-B
Portela de Carnaxide
PT - 2790-138 Carnaxide
Tel. +351 214 203 900
www.contimetra.com
e-mail: industria@contimetra.com

■ Romania

Synchro Comp s.r.l.
ID Sarbu street no. 13 Camin 3
RO - Craiova 200561 Dolj
Tel. +40 317 800 000
www.synchro.ro
e-mail: office@synchro.ro

■ Russia

POLTRAF CIS
Lyubotinsky pr. 5
RU - 196105 St.-Petersburg
Tel. +7 812 244 94 24
www.poltraf.ru
e-mail: info@poltraf.ru

■ Spain

Trafag España S.L.
Parque Tecnológico Bizkaia
Edificio 101 – E
ES - 48170 Zamudio (Bizkaia)
Tel. +34 94 641 40 63
www.trafag.es
e-mail: info@trafag.es

■ Sweden

Regal Components AB
Lefflersgatan 1
SE - 754 50 Uppsala
Tel. +46 18 657 000
www.regal.se
e-mail: info@regal.se

■ Switzerland

see 'Headquarters'
Tel. +41 44 922 32 32
www.trafag.com
e-mail: trafag@trafag.com

■ Turkey

Alfa Elektronik Sensor Sanayi Ve Ticaret A.S.
Tuzla Kimya Sanayicileri O.S.B
Melek Aras Bulvari No: 67
TR - 34956 Tuzla-ISTANBUL
Tel. +90 216 399 44 04
www.alfasanayi.com
www.trafag.com.tr
e-mail: info@alfasanayi.com

■ Ukraine

Soliton Ltd.
19, Akademika Tupoleva str
UA - 04128 Kiev
Tel. +38 (044) 223 9843
www.soliton.com.ua
e-mail: soliton@soliton.com.ua

Trafag international

Asia

China

Engines, Shipbuilding: Entire China

Marinequip China Co., Ltd.
Room 1306A, 13.F, Jiaxing Building
877 Dong Fang Road
CN - Shanghai 200122
Tel. +86 21 6445 2545
e-mail: xuzhun@marinequip.com.cn

Engines:

Entire China
Shanghai SKY Trading Co., Ltd.
Bond Shanghai Office
Rm. 24D, Unit.2,
No. 1251 Jiangning Rd
CN - Shanghai 200060
Tel: +86 21 6276 1312
www.sky-trading.com.cn
e-mail: bondwu@sky-trading.com.cn

General Industry:

Entire China
Beijing Macrosense Co., Ltd
The 2nd Floor, Building 60, No. 2
Jingyuanbeijie,
Yizhuang Economic Development Zone,
Daxing District,
CN - Beijing 100176
Tel. +86 10 8260 1626/8260 1361
Mobile +86 1370 103 7546
www.bjhjd.com.cn
e-mail: wanggui@macrosense.cn

SF6 Gas Density Monitoring:

Entire China
ETIC Electrical Equipment Co., Ltd.
A610 Pioneering Square,
No. 48 Keji Road,
CN - Xi'an 710075
Tel. +86 29 8799 9981/2/3
www.etic.cn
e-mail: info@etic.cn

India

Trafag Controls India Pvt. Ltd.
Plot no-248, Sector-7
IMT Manesar
IN - Gurgaon-122050,
Haryana
Tel. +91 124 404 47 20
www.trafag.com
e-mail: trafagindia@trafag.com

Indonesia

Please contact our headquarters
Switzerland
Tel. +41 44 922 32 32
www.trafag.com
e-mail: trafag@trafag.com

Israel

Timcon Technologies Systems Ltd
3, Josef Levi St.
Industrial Zone P.O.B. 1057
IL - Kiryat Bialik 27110
Tel. +972 4 8742605
www.timcon.co.il
e-mail: timcon@timcon.co.il

Japan

Trafag Japan Co., Ltd.
2-13-5 Shiba Daimon
Minato-ku
JP - Tokyo 105-0012
Tel. +81 3 6435 7506
www.trafag.jp
e-mail: trafagjapan@trafag.com

Korea

Hwajin Enterprise Co., Ltd.
25, Mieumsandan 2-ro
Gangseo-gu
KR - Busan (46748)
Tel. +82 51 831 9447
www.trafagkorea.com
e-mail: hwa-jin@hwa-jin.com

Malaysia

SENSING Process Instruments Sdn Bhd
30, Jalan 30/119A
Taman Taynton View, Cheras,
MY - 56000 Kuala Lumpur
Tel. +603 9235 1038
www.sensing.com.my
e-mail: info@sensing.com.my

Philippines

West Point Engineering Supplies
West Point Building, Bacood Street,
Barangay Patubig
Marilao Bulacan
Philippines 3019
Tel. +63 44 797 2524
www.westpointengineering.com.ph
sales@westpointengineering.com.ph

Singapore

General Industry:

IndCon Technology (S) Pte. Ltd.
Blk 2021 Bukit Batok St 23 #04-210
SG - Singapore 659526
Tel. +65 6908 4838
www.indcontechtechnology.com
e-mail: sales@indcontechtechnology.com

Singapore

Shipbuilding:

Bond Instrumentation (S) Pte. Ltd.
8 Gul Street 3
SG - Singapore 629265
Tel. +65 68 651 800
www.bond.com.sg
e-mail: bondsales@bond.com.sg

Taiwan

Daybreak International (Taiwan) Corp.
3 F, No.124, Chung-Cheng Road,
Shihlin 11145
TW - Taipei
Tel. +886 2 8866 1234
www.daybreak.com.tw
e-mail: day111@ms23.hinet.net

Thailand

Themtech Co., Ltd.
127 Soi Srimuang-Anusorn
Sutthisarnvinijchai Rd., Dindaeng
TH - Bangkok 10400
Tel. +662 693 6629
www.primusthai.com
e-mail: sales@themtech.co.th

Trafag international

Asia

■ United Arab Emirates

Abdulla Bin Hamid Trading LLC
Po Box 30495
AE - Dubai
Tel. +971 4 2241464
www.accutech.ae
e-mail: sales@accutech.ae

■ Vietnam

GNN Co. Ltd
33 Hoa Hong 2, Ward 2
Nhu Nhuan Dist. HCMC
Tel. +84 8 3517 4923
www.gnnvietnam.com
e-mail: contact@gnnvietnam.com

America

■ USA

Trafag, Inc.
8848 Red Oak Boulevard, Ste. I
US - Charlotte, NC 28217
Tel. +1 704 343 6339
www.trafag.us
e-mail: salesus@trafag.com

■ Canada

Indumart Inc.
25 Denison Street
CA - Markham, L3R 1B5,
Ontario
Tel. +1 905 944 9998
www.indumart.com
e-mail: sales@indumart.com

South America

■ Brazil

G&M Comercio de Produtos Ltda.
Rua Senador Queiros, 165
BR - 09050-300 Santo Andre - São Paulo
Tel. +55 11 4425-4245
www.gmtestemedicao.com.br
e-mail: vendas@gmtestemedicao.com.br

Sense Eletrônica
Rua Tuiuti 1237
BR - 03081-012 Tatuapé São Paulo SP
Tel. +55 11 2145-0421
www.sense.com.br
www.trafag.com.br
e-mail: vendas@sense.com.br

■ Colombia

Surti Industria S.A.S
Carrera 33 No 38 A Sur 46
Envigado - Antioquia
Tel. +57 4 3 34 3283
www.surtiindustria.com.co
e-mail: surtiindustria@une.net.co

Africa

■ South Africa

ICS (Pty) Ltd.
Instrumentation & Control Systems
1 Claerhout Crescent
ZA - Sasolburg, 1947 RSA
Tel. +27 82 900 83 12
www.instcon.co.za
e-mail: info@instcon.co.za

Australia, Oceania

■ Australia

Dart Instruments Pty. Ltd.
250 Military Road
AU - Neutral Bay NSW 2089
Tel. +61 2 8456 7550
www.trafag.com.au
e-mail: sales@dartinstruments.com.au

■ New Zealand

Eurotec Limited
750C Great South Road
Penrose
P.O. Box 14543
NZ - Panmure Auckland
Tel. +64 9 579 1990
www.eurotec.co.nz
e-mail: sales@eurotec.co.nz

Reliable quality

Worldwide represented, globally trusted, Swiss based



Headquarters

Switzerland

Subsidiaries

Austria
Czech Republic
France
Germany
Great Britain
India
Italy
Japan
Poland (Joint Venture)
Russia (Joint Venture)
Spain
USA

Representatives

Australia	Greece	Portugal
Belgium	Hungary	Romania
Brazil	Iceland	Singapore
Canada	Indonesia	South Africa
China	Israel	Sweden
Colombia	Korea	Taiwan
Croatia	Malaysia	Thailand
Cyprus	Netherlands	Turkey
Denmark	New Zealand	Ukraine
Estonia	Norway	United Arab Emirates
Finland	Philippines	Vietnam

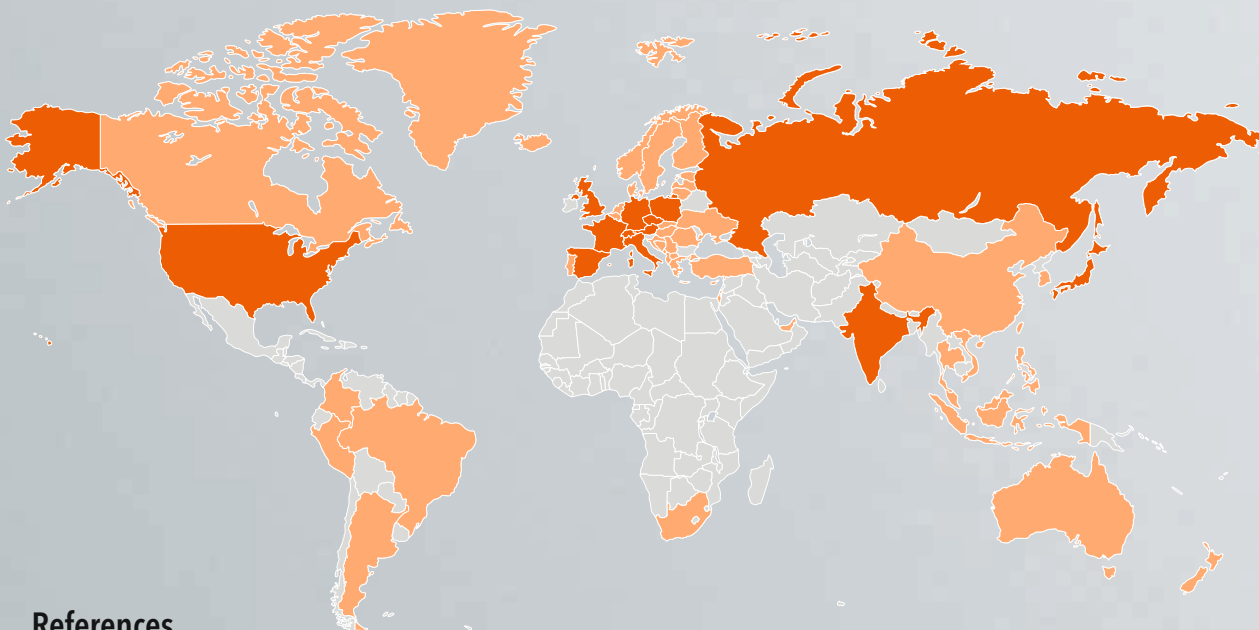

References

ABB | AIT | AGK | Alstom | Areva T&D | Atos | AVL | Benninghoven | Bharat Heavy Electrical | Blohm & Voss | Bombardier | Bosch Rexroth | BMW Rolls-Royce
Bühler | Caterpillar | Charmilles | Dalian Marine Diesel Ltd. | Detroit Diesel | Deutsche Bahn AG | Doosan Group | Dräger | Electrolux | Elektrobudowa S.A.
Faiveley | Fincantieri | Flender | Goninan | Greenfield | G&W | Hermetic Pumpen | Roche | Hudong Heavy Machinery | Hyundai Heavy Industries | IAV
Ingersoll Rand | Iveco | KOMA | MAN B&W | Melag | Mitsubishi | MTU | Noske-Kaeser | Oilon | Ormat Turbines | Parker | PESA | Philips | PKN Orlen S.A.
PMC | Polarteknik | Promeco | Queensland Rail | Reintjes | Renk | Rolls-Royce | Schindler | Schneider Electric | Schottel | Sciteq-Hammel | Siemens | SNCF
STX Heavy Industries | Thermax Limited | Toshiba | Trumpf | Verolme Shipyard | Vesta | Viessmann | Voith | Wärtsilä | Westfalia Separator | W&H
Yichang Marine Diesel Ltd | York | ZF Marine