

75x75x30 mm

10.8~15.5 CFM



■ Specification

Model	Bearing	Rated Voltage	Power Current	Power Consumption	Speed	Airflow	Static Pressure	Noise	Weight	Curve
	2BALL Sleeve	(VDC)	(mA)	(WATTS)	(RPM)	(CFM)	(inch-H ₂ O)	(dB(A))	(g)	
PF75301B1-1B000-A99	☛	12	200	2.40	3400	15.5	0.57	42.0	85.0	1
PF75301B2-1B000-A99	☛	12	142	1.71	3000	13.8	0.43	38.6	85.0	2
PF75301B3-1B000-A99	☛	12	82	0.99	2400	10.8	0.24	32.9	85.0	3
PF75302B1-1B000-A99	☛	24	115	2.76	3400	15.5	0.57	42.0	88.0	1
PF75302B2-1B000-A99	☛	24	80	1.92	3000	13.8	0.43	38.6	88.0	2
PF75302B3-1B000-A99	☛	24	47	1.13	2400	10.8	0.24	32.9	88.0	3

■ Function R Type : F99 / F Type : G99 / PWM : H99, Q99, S99

■ Air Flow-Static Pressure Characteristics

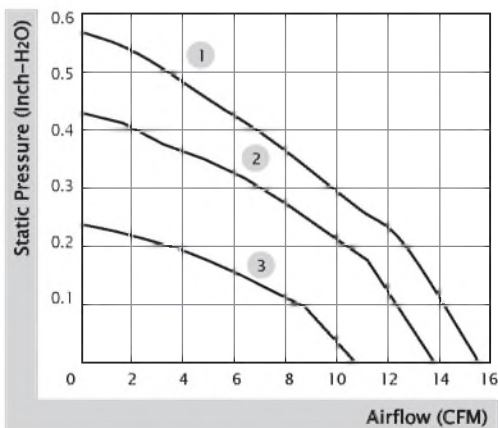

■ External dimensions(mm)

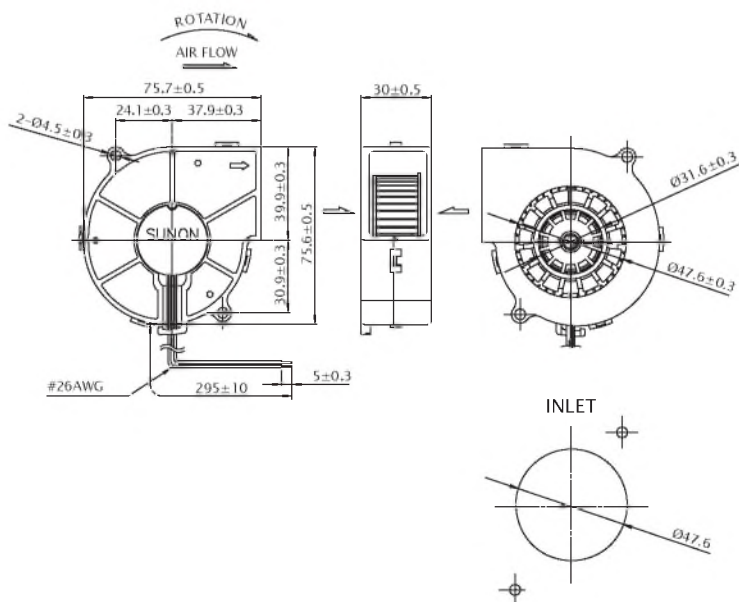

※ All model could be customized. Please contact with Sunon Sales.

※ Specifications are subject to change without notice. Please Visit SUNON website at www.sunon.com for update information.

■ RD / FG Output Signal

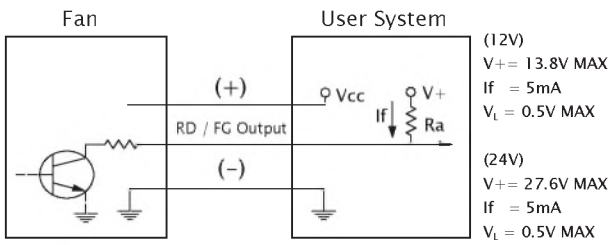

[RD Signal]

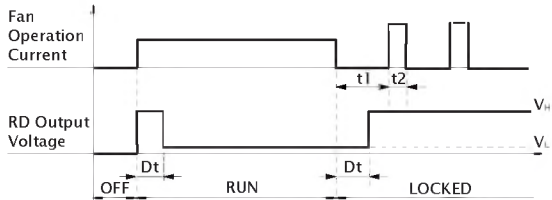

[FG Signal]

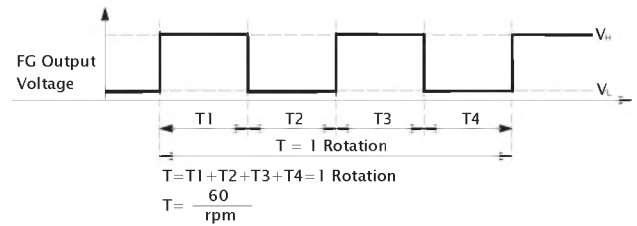

■ PWM Input Signal

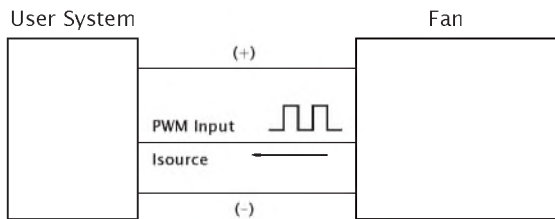

PWM FREQUENCY: 25KHZ
 Isource=0.5mA at PWM Input Voltage 0V
 The speed is default to be maximum if PWM input pin is unconnected.
 Min. start up duty cycle is 10%.

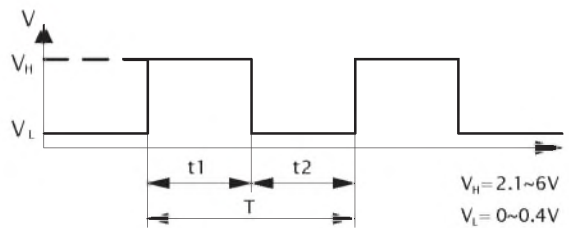

1. Period : $T = \frac{1}{f_{PWM}} = t1 + t2(\text{sec})$
2. Duty Cycle (D.C.) : $\frac{t1}{t1+t2} \times 100 = \frac{t1}{T} \times 100(\%)$

■ PWM Curve

